

GTV



**KATALOG PRODUKTÓW
PRODUCT CATALOGUE
КАТАЛОГ ПРОДУКЦИИ**

ÓŚWIETLENIE MEBLÓWE
FURNITURE LIGHTING
МЕБЕЛЬНОЕ ОСВЕЩЕНИЕ

SYSTEMY PRZESUWNE
SLIDING DOOR SYSTEMS
РАЗДВИЖНЫЕ СИСТЕМЫ

AKCESORIA DEKORACYJNE
DECORATIVE ACCESSORIES
ЛИЦЕВАЯ ФУРНИТУРА

AKCESORIA FUNKCYJNE
FUNCTIONAL ACCESSORIES
ФУНКЦИОНАЛЬНАЯ ФУРНИТУРА

PL GTV to międzynarodowy producent akcesoriów meblowych i oświetlenia. Jest jedną z najdynamiczniej rozwijających się firm w Polsce. Spółka obecna jest na kilkudziesięciu rynkach w Europie, Azji i Ameryce, a produkty z logo GTV znajdują się w milionach domów i biur na całym świecie. GTV jest firmą w 100% z polskim kapitałem. Spółka dysponuje własnym zapleczem techniczno-logistycznym umożliwiającym swobodne prowadzenie działalności o ogólnoświatowym zasięgu. Siedziba firmy to nowoczesne, w pełni zinformatyzowane centrum logistyczne w Pruszkowie, w pobliżu autostrady A2. Na jego terenie znajduje się biurowiec oraz dwa magazyny o powierzchni 27 000 m kw. z wydzielonymi składami celnymi, mieszczące 35 000 europalet. Portfolio GTV to jedna z najbardziej kompletnych ofert na rynku. Obejmuje kilka tysięcy produktów, w kilkudziesięciu grupach produktowych, w tym m.in.: zawiasy, prowadnice, podnośniki, uchwyty, wyposażenie garderoby i kuchni oraz oświetlenie LED.

EN GTV is an international producer of furniture accessories and LED lighting. GTV has over 20 years of experience in cooperation with the largest furniture manufacturers in the world and millions of customers using the company's products. Today GTV is one of the international leaders in distribution of furniture accessories and LED lighting, present on dozens of markets worldwide. GTV's headquarter is a modern logistics center, located 25 km from the center of the Polish capital, Warsaw. GTV's head office is a four-story office building and two warehouses on an area of 27000 square meters with storage capacity of over 35,000 euro pallets. With its modern infrastructure, the company is able to fulfill orders from all over the world at the time indicated by the customer. GTV implementing its long-term business strategy, actively promotes its products by participating in the world's most prestigious trade fairs e.g. in Russia, Germany, Italy, Poland, Brazil. Professional service, competent team of specialists and transparent procedures allow us to effectively meet the needs of business partners.

RU GTV – это международный производитель мебельной фурнитуры и освещения. Мы работаем в десятках стран Европы, Азии и Америки, а продукция с логотипом GTV известна во всем мире. GTV – это современный, полностью информатизированный логистический центр возле Варшавы. На его территории находится офисное здание и два склада площадью 27 000 м2 с отдельными таможенными складами вместимостью 35 000 европаллет. Дополнительно фирма располагает складскими помещениями площадью почти 5000 квадратных метров. Ассортимент компании GTV включает несколько тысяч наименований продукции: петли, направляющие, подъемники, ручки, оснащение для гардероба и кухни, светодиодное освещение.





GTV

FURNITURE
ACCESSORIES

PL GTV Furniture Accessories, marka obecna na rynku od ponad dwudziestu lat to niekwestionowany lider dostarczający najbardziej kompletne portfolio akcesoriów dla branży meblarskiej. Dzięki przemyślanej strategii rozwoju, marka oferuje nieosiągalną dla innych firm relację ceny do jakości, dostarczając funkcjonalne oraz zaprojektowane zgodnie z najnowszymi trendami produkty w przystępnych cenach.

EN GTV Furniture Accessories brand is present on the market for over 20 years, building its position as one of the international leaders. The company is present in Europe, Asia and America, whereas products with the GTV logo are to be found in millions of households and offices worldwide. Thanks to carefully planned strategy and logistics, GTV can offer products with an unreachable for other companies price to quality ratio.

RU Мебельная фурнитура с логотипом GTV известна на рынке уже более двадцати лет, а портфолио компании является одним из наиболее полных предложений на мебельном рынке. Благодаря продуманной стратегии развития, эффективному управлению и открытости к новым идеям, компания GTV быстро стала лидером в дистрибуции мебельной фурнитуры. Секрет успеха компании заключается в предоставлении продукции высокого качества по приемлемой цене.

GTV

SLIDING DOOR SYSTEMS

PL GTV Sliding Door Systems, to marka która powstała w 2014 r. z myślą o profesjonalistach poszukujących rozwiązań ułatwiających i przyspieszających montaż drzwi przesuwnych. Systemy przesuwne zostały zaprojektowane przez naszych konstruktorów, dla których inspiracją były opinie polskich stolarzy. Dzięki tej owocnej współpracy powstał produkt, który nie tylko przekonuje praktycznymi, konstrukcyjnymi ulepszeniami. Są to również szczegóły decydujące o przewadze produktu jak unikatowy materiał, z którego wykonane zostały kółka w systemach jezdnych.

EN GTV Sliding Door Systems is a brand developed in 2014, for professionals seeking reliability and highest quality. Our systems have been created to meet the needs, of the most demanding customers. The idea behind the systems was inspired by carpenters, who tend to look for solutions, that will make their work more effective. GTV Sliding Door Systems offer not only practical constructional improvements. But also highest quality of components. The whole system is based on reliable elements, especially rollers thanks to which this system stands out of the competition. All of the functional accessories have been carefully selected and underwent thorough strict quality control.

RU Раздвижные системы GTV - бренд, созданный в 2014 году с мыслью о профессионалах, ищущих новые возможности, позволяющие ускорить процесс установки раздвижных дверей. Раздвижные системы GTV были запроектированы по инициативе производителей мебели и являются авторской разработкой инженеров компании GTV. В результате плодотворной работы был создан продукт, интересный не только своими техническими решениями, но и отличающийся качеством используемого материала в нижних ходовых элементах.

GTV

LIGHTING

PL Marka GTV Lighting została wprowadzona na rynek 2007 r. oferując rozwiązania oświetleniowe przeznaczone do biur, budynków przemysłowych, magazynowych i użyteczności publicznej opartych na technologii LED. Portfolio zawiera również produkty LED dla klientów indywidualnych – źródła LED, oświetlenie meblowe. GTV Lighting to szeroka i kompletna oferta, elastyczność w podejściu do partnerów biznesowych a także serwis.

EN The GTV Lighting brand was launched in 2007, it has been created, to provide professional lighting solutions for offices, industrial buildings and warehouses - based on LED technology. The portfolio also includes LED solutions for private consumers – home and garden lighting, furniture lighting. GTV Lighting offers also a wide and complete portfolio of services, such as lighting planning consulting.

RU Товарная группа GTV освещение появилась в ассортименте компании в 2007 году и представляет собой подборку интересных световых решений для офисов, промышленных зданий, складских помещений, общественных зданий, а также решений подходящих индивидуальным клиентам – источники светодиодного освещения и освещение для мебели. GTV освещение предлагает широкий спектр продукции и гибкость в подходе к бизнес-партнёрам и услугам, которые мы предоставляем.

AKCESORIA FUNKCYJNE FUNCTIONAL ACCESSORIES ФУНКЦИОНАЛЬНАЯ ФУРНИТУРА

Zawiasy Hinges Петли	8 – 41
Amortyzatory Buffers Амортизаторы	41 – 47 57 – 59
Podnośniki Lifts Подъёмники	48 – 56
Prowadnice Slides Направляющие	60 – 91
Systemy szuflad Drawer systems Выдвижные ящики	92 – 131
Elementy łączeniowe Brackets and fittings Соединительные элементы	132 – 166
Listwy Work top strip Панки для столешниц	167 – 170
Mocowania do rur Rails accessories and fittings Крепление для труб	171 – 190
Wyposażenie garderoby Wardrobe accessories Наполнение для шкафов-купе	191 – 225
Akcesoria kuchenne Kitchen accessories Кухонные аксессуары	226 – 256
Akcesoria biurowe Office accessories Аксессуары для офиса	257 – 262
Inne Other Другие	263 – 265

AKCESORIA DEKORACYJNE DECORATIVE ACCESSORIES ЛИЦЕВАЯ ФУРНИТУРА

Uchwyty Handles Ручки	268 – 361
Wieszaki Hooks Крючки	364 – 380



Nóżki meblowe Furniture legs Мебельные ножки	381 – 409
Nogi meblowe Furniture legs Мебельные опоры	410 – 416
Rolki meblowe Furniture castors Мебельные колёсики	417 – 421
Zamki meblowe Cabinet locks Замки	422 – 429



SYSTEMY PRZESUWNE SLIDING DOOR SYSTEMS РАЗДВИЖНЫЕ СИСТЕМЫ

Dotny układ jezdny Bottom-running systems Нижняя ходовая система	432 – 462
Górny układ jezdny Top-running systems Верхняя ходовая система	463 – 467



OŚWIETLENIE MEBLOWE FURNITURE LIGHTING МЕБЕЛЬНОЕ ОСВЕЩЕНИЕ

Taśmy LED LED strips Светодиодные ленты	470 – 472
Profile LED LED profiles Профили LED	473 – 494
Oprawy LED LED fittings Светодиодные светильники	494 – 513
Oprawy halogenowe Halogen fitting Галогенные светильники	514 – 515
Akcesoria Accessories Аксессуары	516 – 538
Przedłużacze biurkowe Desk power sockets Выдвижные удлинители	539 – 549

**AKCESORIA FUNKCYJNE
FUNCTIONAL ACCESSORIES
ФУНКЦИОНАЛЬНАЯ ФУРНИТУРА**

Zawiasy Hinges Петли	8 – 41
Amortyzatory Buffers Амортизаторы	41 – 47 57 – 59
Podnośniki Lifts Подъёмники	48 – 56
Prowadnice Slides Направляющие	60 – 91
Systemy szuflad Drawer systems Выдвижные ящики	92 – 131
Elementy łączeniowe Brackets and fittings Соединительные элементы	132 – 166
Listwy Work top strip Планки для столешниц	167 – 170
Mocowania do rur Rails accessories and fittings Крепление для труб	171 – 190
Wyposażenie garderoby Wardrobe accessories Наполнение для шкафов-купе	191 – 225
Akcesoria kuchenne Kitchen accessories Кухонные аксессуары	226 – 256
Akcesoria biurowe Office accessories Аксессуары для офиса	257 – 262
Inne Other Другие	263 – 265





MB
MODERN BOX

Orientacyjna ilość zawiasów puszkowych Ø35*

* nie dotyczy modeli specjalnych o szerokim kącie otwarcia

Approximate amount of hinges Ø35*

* not applicable for special hinges with wide opening angle

Приблизительное количество шарнирных петель Ø35*

* не касается специальных моделей с широким углом открывания

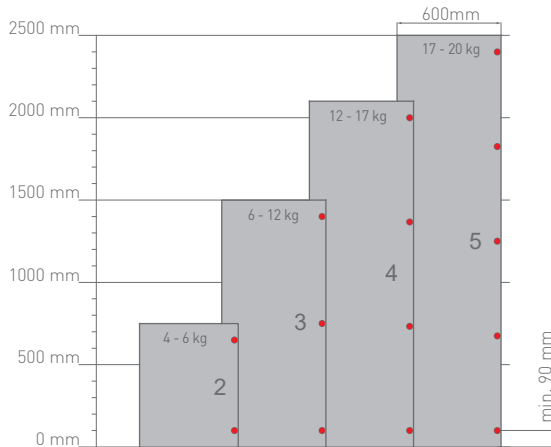
**Orientacyjna ilość zawiasów puszkowych Ø26 oraz Ø35***

* dotyczy modeli specjalnych o szerokim kącie otwarcia

Approximate amount of hinges Ø26 and Ø35

* not applicable for special hinges with wide opening angle

Приблизительное количество шарнирных петель Ø26 и Ø35*

* касается специальных моделей с широким углом открывания

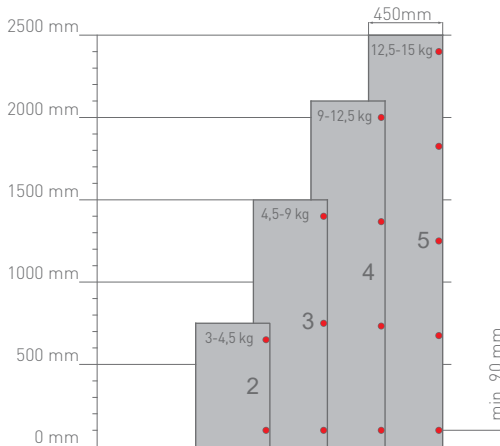

- Ilość użytych zawiasów jest zależna od wysokości, szerokości i ciężaru frontu.
- W celu zapewnienia stabilności, odległość między zawiasami powinna być jak największa.
- Przed przystąpieniem do seryjnej produkcji należy przeprowadzić próbę montażu i sprawdzić poprawność funkcjonowania.
- To ensure stability, the distance between the hinges should be as big as possible.
- Number of hinges that should be used, depends on the height, width and weight of the front.
- Before starting mass production, mounting tests should be performed in order to ensure proper functioning.
- Количество использованных петель зависит от высоты, ширины и веса фасада.
- Для обеспечения стабильности, расстояние между петлями должно быть как можно больше.
- Перед началом серийного производства необходимо провести пробу монтажа и проверить исправность функциональности петель.

Zawias hydrauliczny SOLID PLUS, nakładany
 Hydraulic cup hinge SOLID PLUS, overlay door
 Гидравлическая петля SOLID PLUS, накладная

NEW

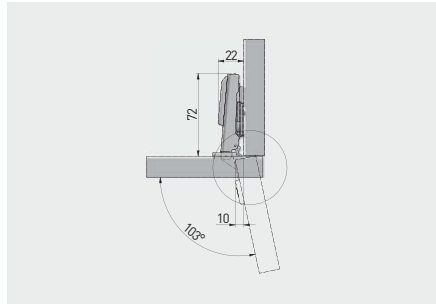

ZM-DCHC09-3DBE0	H=0	—	—	nikiel nickel никель	stal steel сталь
ZM-DCHC09-3ZBE0		—	x 2		



Zawias hydrauliczny SOLID PLUS, bliźniaczy
 Hydraulic cup hinge SOLID PLUS, twin overlay door
 Гидравлическая петля SOLID PLUS, полунакладная

NEW

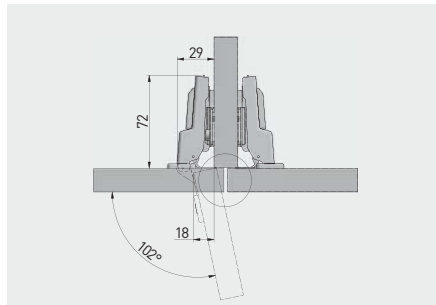

ZM-DCHC08-3DBE0	H=0	—	—	nikiel nickel никель	stal steel сталь
ZM-DCHC08-3DZE0		—	x 2		



Zawias hydrauliczny SOLID PLUS, wpuszczany
 Hydraulic cup hinge SOLID PLUS, inset door
 Гидравлическая петля SOLID PLUS, внутренняя

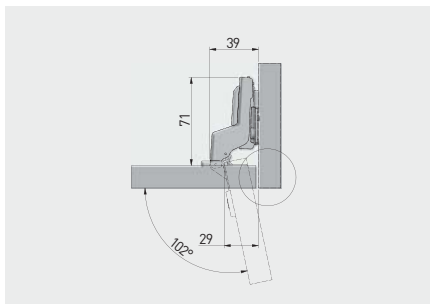

ZM-DCHC07-3DBEO	H=0	—	—	nikiel nickel	stal steel
ZM-DCHC07-3DZEO		—	x 2	никель nickel	сталь steel



Zawias hydrauliczny ECHC, nakładany
 Hydraulic cup hinge ECHC, overlay door
 Гидравлическая петля ECHC, накладная

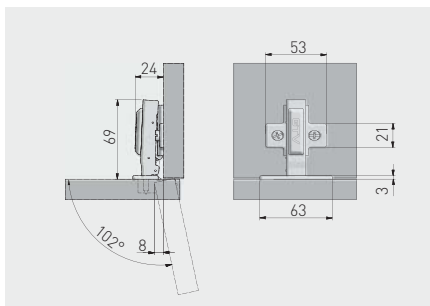

ZM-ECHC09BEO	H=0	x 4	—	nikiel nickel	stal steel
ZM-ECHC09ZEO		x 2	x 2	никель nickel	сталь steel



Zawias hydrauliczny ECHC, bliźniaczy
 Hydraulic cup hinge ECHC, twin overlay door
 Гидравлическая петля ECHC, полунакладная

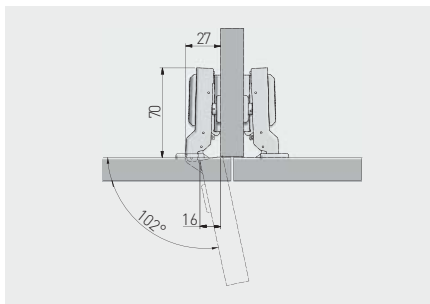

ZM-ECHC08BEO	H=0	x 4	—	nikiel nickel	stal steel
ZM-ECHC08ZEO		x 2	x 2	никель	сталь



Zawias hydrauliczny ECHC, wpuszczany
 Hydraulic cup hinge ECHC, inset door
 Гидравлическая петля ECHC, внутренняя

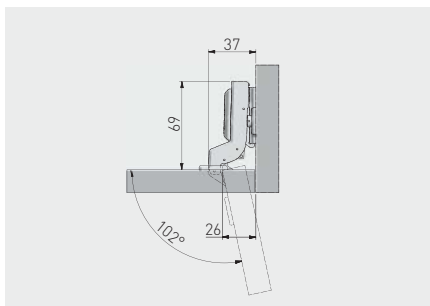

ZM-ECHC07BEO	H=0	x 4	—	nikiel nickel	stal steel
ZM-ECHC07ZEO		x 2	x 2	никель	сталь



Zawias hydrauliczny ECHC, nakładany
 Hydraulic cup hinge ECHC, overlay door
 Гидравлическая петля ECHC, накладная

NEW

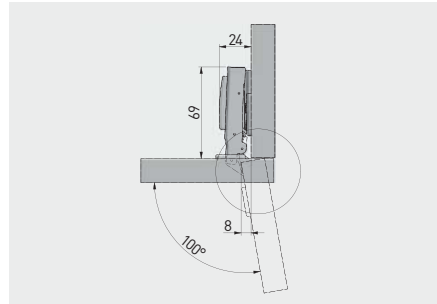

ZM-ECHC09H04-BE	H=0	x 6	—	nikiel nickel никель	stal steel сталь



Zawias hydrauliczny ECHC, bliźniaczy
 Hydraulic cup hinge ECHC, twin overlay door
 Гидравлическая петля ECHC, полунакладная

NEW

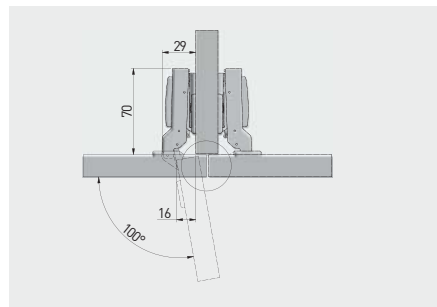

ZM-ECHC08H04-BE	H=0	x 6	—	nikiel nickel никель	stal steel сталь



Zawias hydrauliczny ECHC, wpuszczany
Hydraulic cup hinge ECHC, inset door
Гидравлическая петля ECHC, внутренняя

NEW

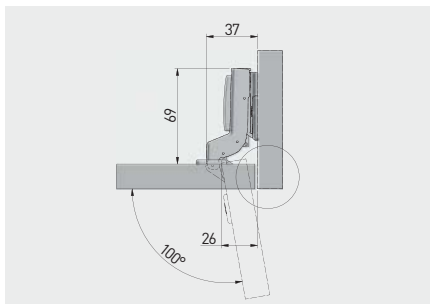

ZM-ECHC07H04-BE	H=0	x 6	—	nikiel nickel ннкель	stal steel сталь



Zawias hydrauliczny HCRE z regulacją prędkości zamknięcia, nakładany
Hydraulic cup hinge HCRE with closing time adjustment, overlay door
Гидравлическая петля HCRE с регулировкой скорости закрытия, накладная

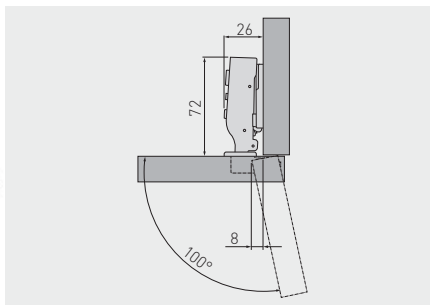

ZM-HCREG09-ZEO	H=0	x 2	x 2	nikiel nickel ннкель	stal steel сталь



Zawias hydrauliczny HCRE z regulacją prędkości zamknięcia, bliźniaczy
 Hydraulic cup hinge HCRE with closing time adjustment, twin overlay door
 Гидравлическая петля HCRE с регулировкой скорости закрытия, полунакладная

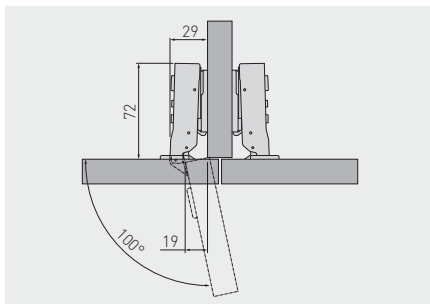

ZM-HCREG08-ZEO	H=0	x 2	x 2	nikiel nickel никель	stal steel сталь



Zawias hydrauliczny HCRE z regulacją prędkości zamknięcia, wpuszczany
 Hydraulic cup hinge HCRE with closing time adjustment, inset door
 Гидравлическая петля HCRE с регулировкой скорости закрытия, внутренняя

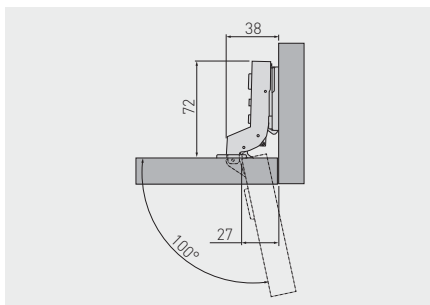

ZM-HCREG07-ZEO	H=0	x 2	x 2	nikiel nickel никель	stal steel сталь



Zawias hydrauliczny CNHC z regulacją mimośrodową, nakładany
 Hydraulic cup hinge CNHC with eccentric adjustment, overlay door
 Гидравлическая петля CNHC с эксцентриком, накладная

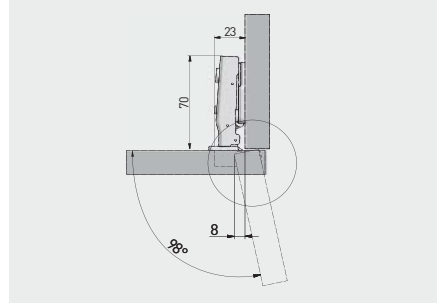

ZM-CNHC09BR2	H=0	-	-	nikiel nickel никель	stal steel сталь



Zawias hydrauliczny CNHC z regulacją mimośrodową, bliźniaczy
 Hydraulic cup hinge CNHC with eccentric adjustment, twin overlay door
 Гидравлическая петля CNHC с эксцентриком, полунакладная

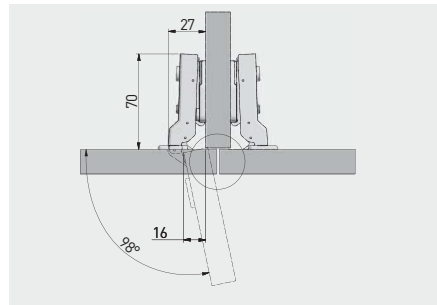

ZM-CNHC08BR2	H=0	-	-	nikiel nickel никель	stal steel сталь



Zawias hydrauliczny CNHC z regulacją mimośrodową, wpuszczany
 Hydraulic cup hinge CNHC with eccentric adjustment, inset door
 Гидравлическая петля CNHC с эксцентриком, внутренняя

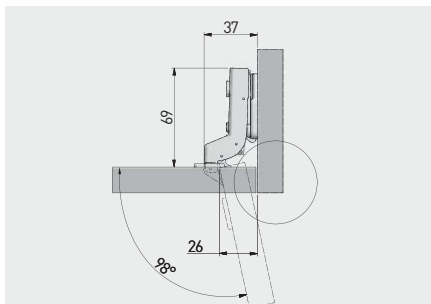

ZM-CNHC07BR2	H=0	-	-	nikiel nickel никель	stal steel сталь



Zawias hydrauliczny INHC, nakładany
 Hydraulic cup hinge INHC, overlay door
 Гидравлическая петля INHC, накладная

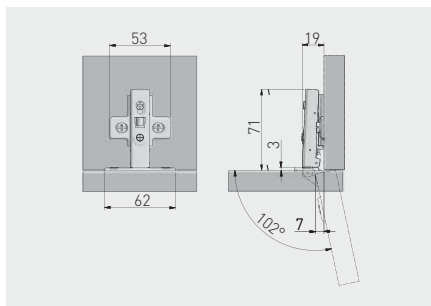

ZM-INHC090BEO	H=0	-	-	nikiel nickel никель	stal steel сталь
ZM-INHC090ZEO		-	x 2		



Zawias hydrauliczny INHC, bliźniaczy
 Hydraulic cup hinge INHC, twin overlay door
 Гидравлическая петля INHC, полунакладная

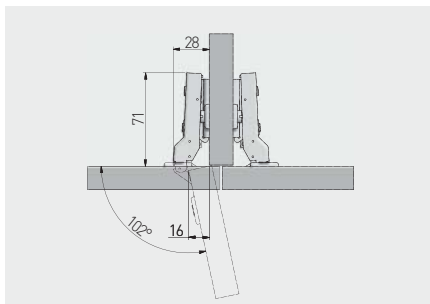

ZM-INHC080BEO	H=0	—	—	nikiel nickel никель	stal steel сталь
ZM-INHC080ZEO		—	x 2		



Zawias hydrauliczny INHC, wpuszczany
 Hydraulic cup hinge INHC, inset door
 Гидравлическая петля INHC, внутренняя

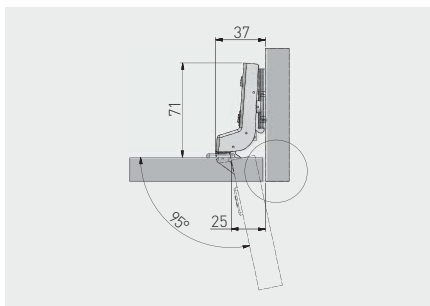

ZM-INHC070BEO	H=0	—	—	nikiel nickel никель	stal steel сталь
ZM-INHC070ZEO		—	x 2		



Zawias kątowy 30°, hydrauliczny HCKT
 Hydraulic corner cup hinge 30° HCKT
 Угловая петля 30°, гидравлическая HCKT

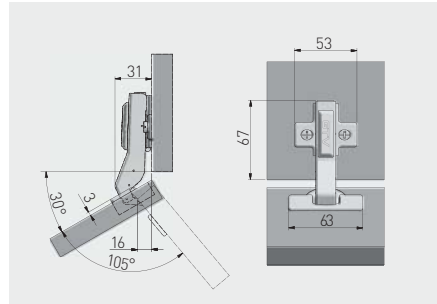

ZM-HCKT30-BE	H=0	x 4	—	nikiel nickel ннкель	stal, ZnAl steel, ZnAl сталь, ZnAl	
ZM-HCKT30-ZE		x 2	x 2			

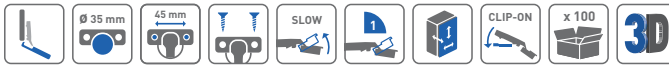

Zawias kątowy 45° hydrauliczny HCKT
 Hydraulic corner cup hinge 45° HCKT
 Угловая петля 45°, гидравлическая HCKT

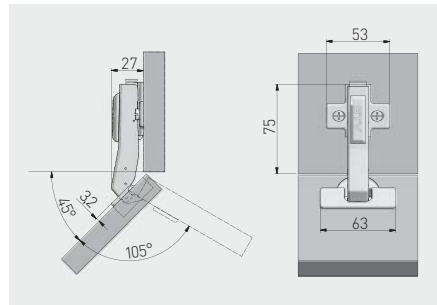

ZM-HCKT45-BE	H=0	x 4	—	nikiel nickel ннкель	stal, ZnAl steel, ZnAl сталь, ZnAl	
ZM-HCKT45-ZE		x 2	x 2			



Zawias kątowy 45° HCKT z regulacją mimośrodową
 Corner hinge 45° HCKT with eccentric adjustment
 Угловая петля 45° HCKT с эксцентриком

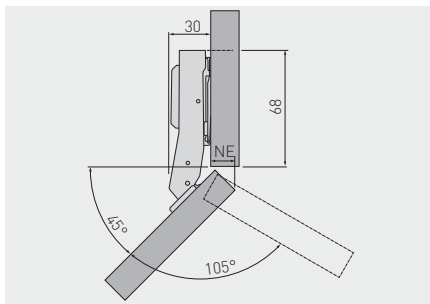

ZM-HCKT45-3DBE0	H=0	—	—	nikiel nickel никель	stal, ZnAl steel, ZnAl сталь, ZnAl



Zawias równoległy hydrauliczny HCKT
 Parallel hydraulic hinge HCKT
 Гидравлическая петля под фальшпанель HCKT

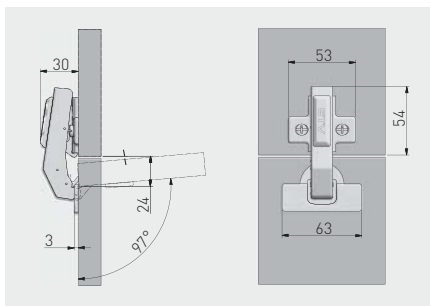

ZM-HCKT90-BE	H=0	x 4	—	nikiel nickel никель	stal, ZnAl steel, ZnAl сталь, ZnAl
ZM-HCKT90-ZE		x 2	x 2		



Zawias równoległy HCKT z regulacją mimośrodową
 Parallel hinge HCKT with eccentric adjustment
 Петля под фальшпанель HCKT с эксцентриком

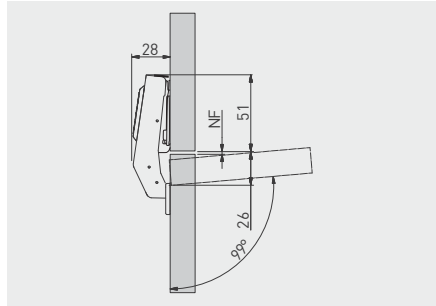

ZM-HCKT90-3DBEO	H=0	—	—	nikiel nickel никель	stal / ZnAl steel / ZnAl сталь / ZnAl



Zawias z ujemnym uskokiem 155° hydrauliczny HCKT
 Hydraulic set-off hinge 155° HCKT
 Гидравлическая петля 155° HCKT

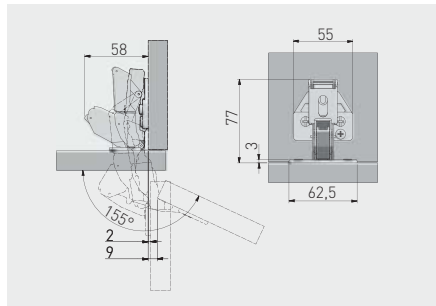

ZM-HCKT155BE	H=0	—	—	nikiel nickel никель	stal steel сталь
ZM-HCKT155ZE		—	x 2		



Zawias 165° hydrauliczny HCKT
 Hydraulic hinge 165° HCKT
 Гидравлическая петля 165° HCKT

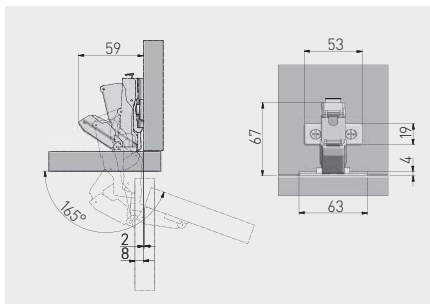

ZM-HCKT165BE	H=0	—	—	nikiel nickel никель	stal, ZnAl steel, ZnAl сталь, ZnAl
ZM-HCKT165ZE		—	x 2		



Zawias 165° hydrauliczny HCKT z regulacją mimośrodową
 Hydraulic hinge 165° HCKT with eccentric adjustment
 Гидравлическая петля 165° HCKT с эксцентриком

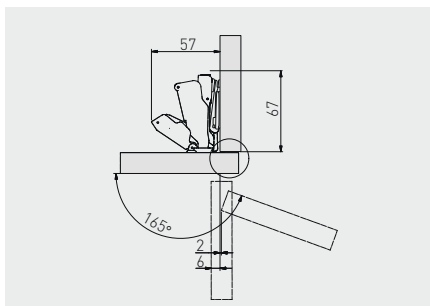

ZM-HCKT165-3DBEO	H=0	—	—	nikiel nickel никель	stal, ZnAl steel, ZnAl сталь, ZnAl



Zawias SOLID, nakładany
Hinge SOLID, overlay door
Петля SOLID, накладная

NEW

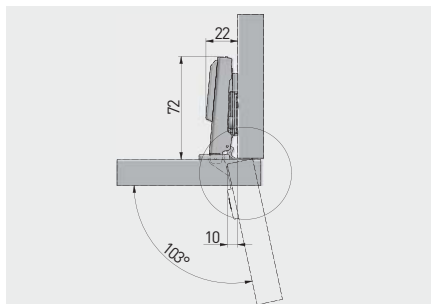

ZP-BIDI09-3DBEO	H=0	—	—	nikiel nickel никель	stal steel сталь



Zawias SOLID, bliźniaczy
Hinge SOLID, twin overlay door
Петля SOLID, полунакладная

NEW

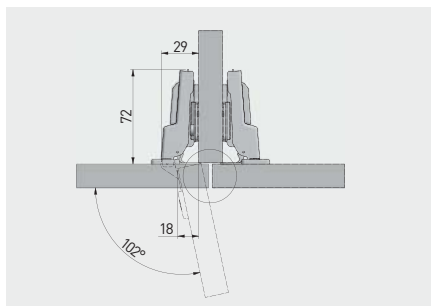

ZP-BIDI08-3DBEO	H=0	—	—	nikiel nickel никель	stal steel сталь



Zawias SOLID, wpuszczany
Hinge SOLID, inset door
Петля SOLID, внутренняя

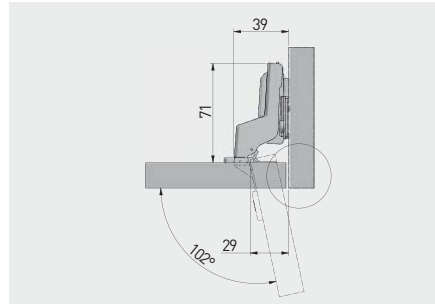

ZP-BIDI07-3DBEO	H=0	—	—	nikiel nickel никель	stal steel сталь



Zawias CONL, nakładany
Hinge CONL, overlay door
Петля CONL, накладная

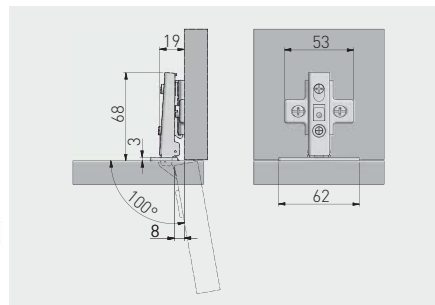

ZP-CONL09-BE	H=0	—	—	nikiel nickel никель	stal steel сталь
ZP-CONL09-ZE		—	x 2		



Zawias CONL, bliźniaczy
Hinge CONL, twin overlay door
Петля CONL, полунакладная

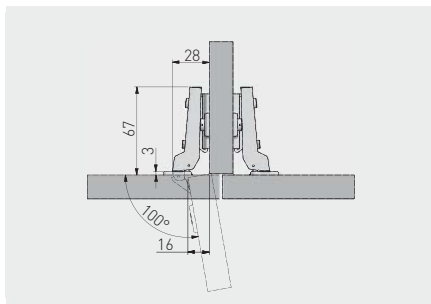

ZP-CONL08-BE	H=0	—	—	nikiel nickel никель	stal steel сталь
ZP-CONL08-ZE		—	x 2		



Zawias CONL, wpuszczany
Hinge CONL, inset door
Петля CONL, внутренняя

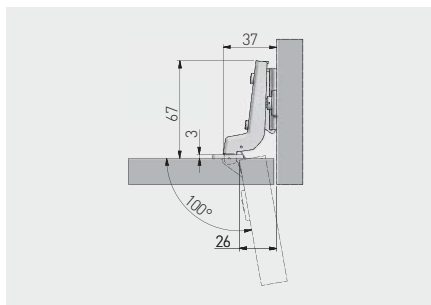

ZP-CONL07-BE	H=0	—	—	nikiel nickel никель	stal steel сталь
ZP-CONL07-ZE		—	x 2		



Zawias BICN, nakładany
Hinge BICN, overlay door
Петля BICN, накладная

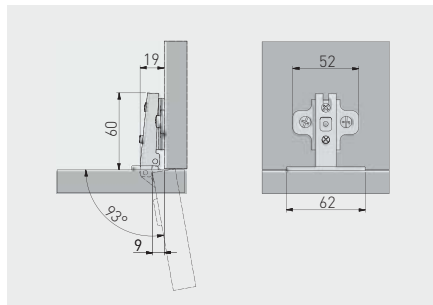

ZP-BICN090BE	H=0	—	—	nikiel nickel никель	stal steel сталь
ZP-BICN090ZE		—	x 2		
ZP-BICN092BE	H=2	—	—	nikiel nickel никель	stal steel сталь
ZP-BICN092ZE		—	x 2		



Zawias BICN, bliźniaczy
Hinge BICN, twin overlay door
Петля BICN, полунакладная

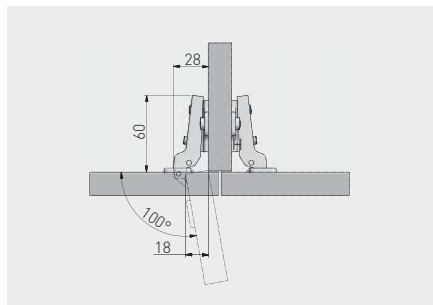

ZP-BICN080BE	H=0	—	—	nikiel nickel никель	stal steel сталь
ZP-BICN080ZE		—	x 2		
ZP-BICN082BE	H=2	—	—	nikiel nickel никель	stal steel сталь
ZP-BICN082ZE		—	x 2		



Zawias BICN, wpuszczany
Hinge BICN, inset door
Петля BICN, внутренняя

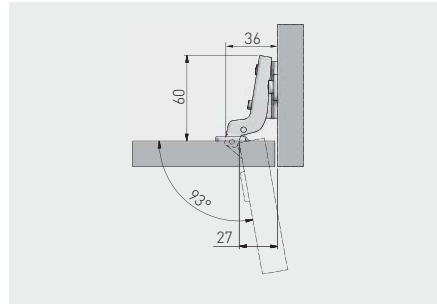

ZP-BICN070BE	H=0	—	—	nikiel nickel никель	stal steel сталь
ZP-BICN070ZE		—	x 2		
ZP-BICN072BE	H=2	—	—		
ZP-BICN072ZE		—	x 2		



Zawias kątowy 30° KT
Corner hinge 30° KT
Угловая петля 30° KT

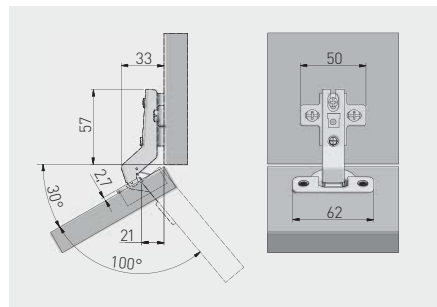

ZP-KT30H2-BE	H=2	—	—	nikiel nickel никель	stal steel сталь



Zawias kątowy 45° KT
 Corner hinge 45° KT
 Угловая петля 45° KT

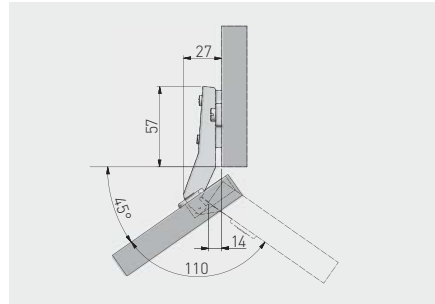

ZP-KT45H2-BE	H=2	—	—	nikiel nickel никель	stal steel сталь
ZP-KT45H2-ZE		—	x 2		



Zawias równoległy KT
 Parallel hinge KT
 Петля под фальшпанель KT

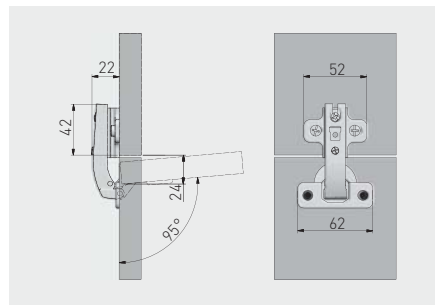

ZP-KT90H2-BE	H=2	—	—	nikiel nickel никель	stal steel сталь
ZP-KT90H2-ZE		—	x 2		



Zawias równoległy – krótkie ramię KTK
 Parallel hinge – short arm KTK
 Петля под фальшпанель с коротким плечем КTK

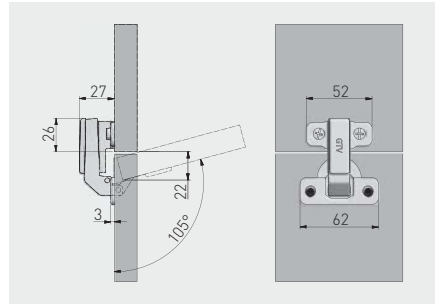

ZP-KTK90H6BE	H=6	—	—	nikiel nickel	stal steel
ZP-KTK90H6ZE		—	x 2	никель nickel	сталь steel



Zawias równoległy nakładany – krótkie ramię KTKN
 Parallel hinge for overlay door – short arm KTKN
 Петля под фальшпанель с коротким плечем, накладная КTKN

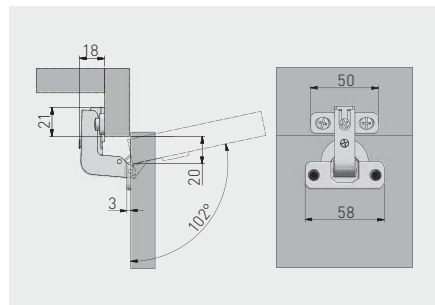

ZP-KTKN90H0	H=0	—	x 2	nikiel nickel	stal, ZnAl steel, ZnAl



Zawias 165° KT
Hinge 165° KT
Петля 165° KT

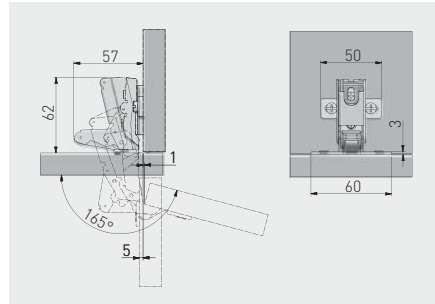

ZP-KT165H2BE	H=2	—	—	nikiel nickel никель	stal steel сталь
ZP-KT165H2ZE		—	x 2		



Zawias uzupełniający 135° KT
Complementary hinge 135° KT
Петля для складных дверей 135° KT

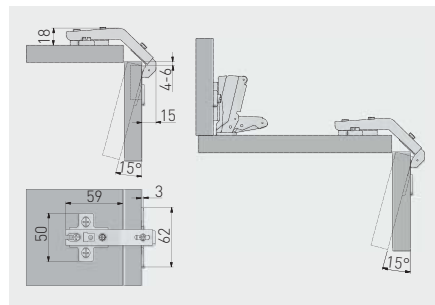

ZP-KT135H2BE	H=2	—	—	nikiel nickel никель	stal, ZnAl steel, ZnAl сталь, ZnAl
ZP-KT135H2ZE		—	x 2		



Zawias bez sprężyny COCA, nakładany
 Hinge without spring COCA, overlay door
 Петля без пружины COCA, накладная

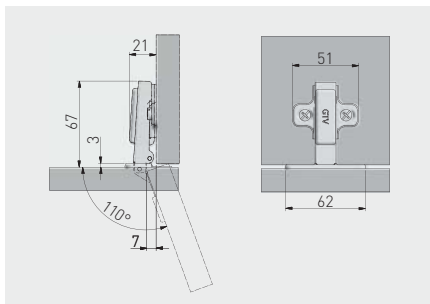

ZP-COCA450-BE	H=0	—	—	nikiel nickel	stal steel
ZP-COCA450-ZE		—	x 2	никель	сталь



Zawias bez sprężyny COCA, wpuszczany
 Hinge without spring COCA, inset door
 Петля без пружины COCA, внутренняя

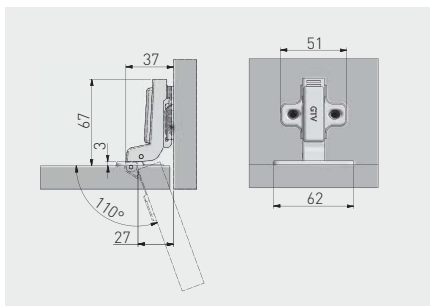

ZP-COCA7450-BE	H=0	—	—	nikiel nickel	stal steel



Zawias samootwierający PO, nakładany
 Self-opening hinge P0, overlay door
 Петля самооткрывающаяся PO, накладная

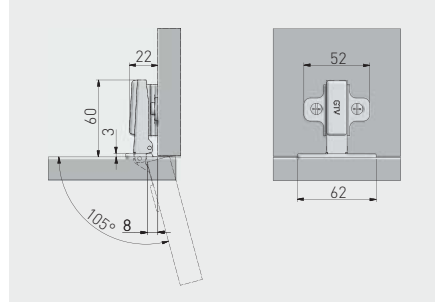

ZP-POH045BEO	H=0	—	—	nikiel nickel никель	stal steel сталь
ZP-POH045ZEO		—	x 2		



Zawias samootwierający PO, wpuszczany
 Self-opening hinge P0, inset door
 Петля самооткрывающаяся PO, внутренняя

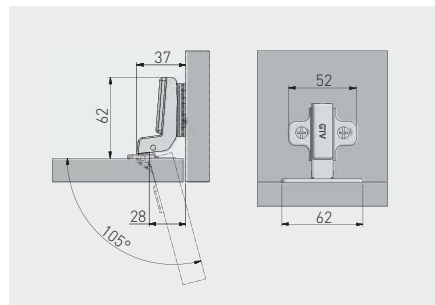

ZP-PO7H045BE	H=0	—	—	nikiel nickel никель	stal steel сталь

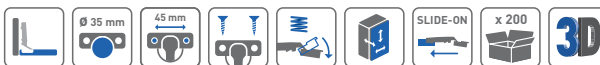

Zawias hydrauliczny mini CIHC, nakładany
 Hydraulic hinge mini CIHC, overlay door
 Гидравлическая петля мини CIHC, накладная

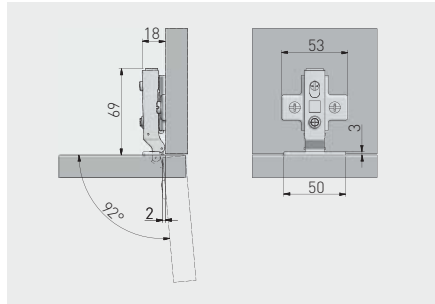

ZP-CIHC090ZE	H=0	-	x 2	nikiel nickel никель	stal, ZnAl / steel, ZnAl / сталь, ZnAl
ZM-CIHC09ZE					stal / steel / сталь

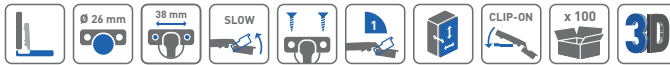

Zawias hydrauliczny mini CIHC, bliźniaczy
 Hydraulic hinge mini CIHC, twin overlay door
 Гидравлическая петля мини CIHC, полунакладная

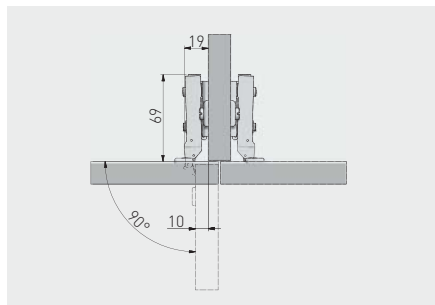

ZP-CIHC080ZE	H=0	-	x 2	nikiel nickel никель	stal, ZnAl / steel, ZnAl / сталь, ZnAl
ZM-CIHC08ZE					stal / steel / сталь



Zawias hydrauliczny mini CIHC, wpuszczany
 Hydraulic hinge mini CIHC, inset door
 Гидравлическая петля мини CIHC, внутренняя

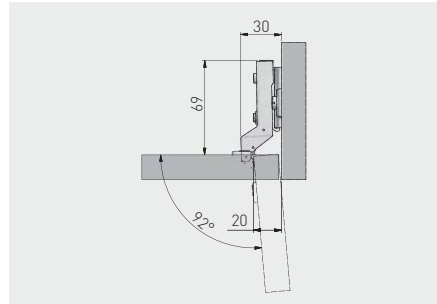

ZP-CIHC070ZE	H=0	-	x 2	nikiel nickel никель	stal, ZnAl / steel, ZnAl / сталь, ZnAl
ZM-CIHC07ZE					stal / steel / сталь

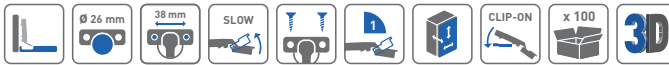

Zawias mini CIBI, nakładany
 Hinge mini CIBI, overlay door
 Петля мини CIBI, накладная

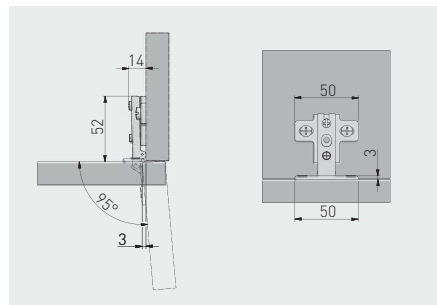

ZP-CIBI9H0ZE	H=0	-	x 2	nikiel / nickel / никель	stal / steel / сталь



Zawias mini CIBI, bliźniaczy
Hinge mini CIBI, twin overlay door
Петля мини CIBI, полунакладная

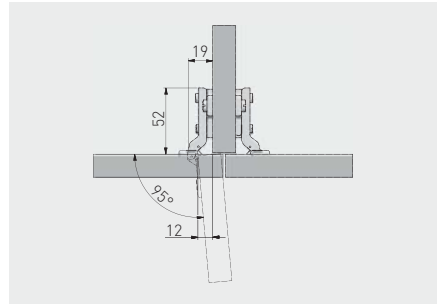

ZP-CIBI8H0ZE	H=0	-	x 2	nikiel nickel ннкель	stal steel сталь



Zawias mini CIBI, wpuszczany
Hinge mini CIBI, inset door
Петля мини CIBI, внутренняя

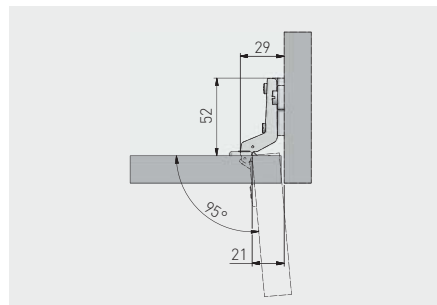

ZP-CIBI7H0ZE	H=0	-	x 2	nikiel nickel ннкель	stal steel сталь



Zawias do szkła CIG, nakładany
 Hinge for glass CIG, overlay door
 Петля для стеклянных дверей CIG, накладная

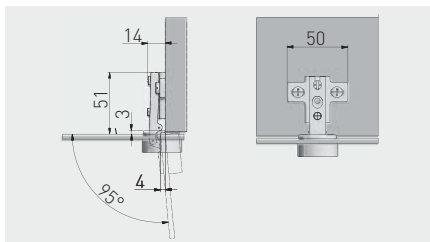

ZP-CIG-09OZE	H=0	—	x 2	nikiel nickel никель	stal, tworzywo steel, plastic сталь, пластмасса		chrom / chrome / хром	
ZP-CIG-09UZE		—	x 2					
ZP-CIG-09UBE		—	—				czarny / black / чёрный	
ZP-CIG-09UZE		—	x 2					
ZP-CIG-19OZE		—	—			x 2		aluminium aluminium алюминий
ZP-CIG-19UZE		—	—			x 2		



Zawias do szkła CIG, wpuszczany
 Hinge for glass CIG, inset door
 Петля для стеклянных дверей CIG, внутренняя

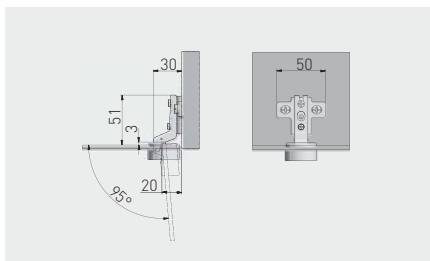

ZP-CIG-07OZE	H=0	—	x 2	nikiel nickel никель	stal, tworzywo steel, plastic сталь, пластмасса		chrom chrome хром
ZP-CIG-07UZE		—	x 2				
ZP-CIG-17OZE		—	x 2				aluminium aluminium алюминий
ZP-CIG-17UZE		—	x 2				



Zawias do ramek aluminiowych, nakładany
 Hinge for aluminium frames, overlay door
 Петля GTV для алюминиевых рамок, с клипом, накладная

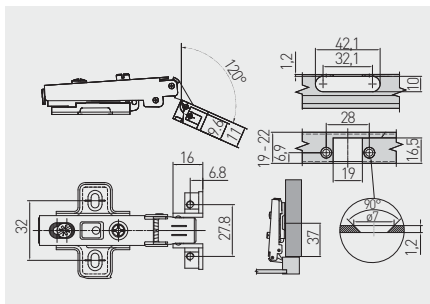

Produkt kompatybilny: profil aluminiowy do frontów: PA-3731-35-50
 Product compatible with aluminum profile for fronts: PA-3731-35-50
 Подходит для алюминиевых профилей под индексом: PA-3731-35-50

ZP-RALUH2-00	H=2	—	—	nikiel nickel plated никель	stal steel сталь



Zawias do ramek aluminiowych, bliźniaczy
 Hinge for aluminium frames, twin overlay door
 Петля GTV для алюминиевых рамок, с клипом, полунакладная

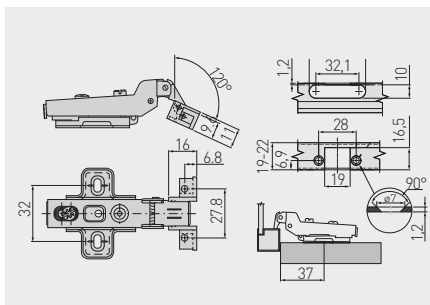

Produkt kompatybilny: profil aluminiowy do frontów: PA-3731-35-50
 Product compatible with aluminum profile for fronts: PA-3731-35-50
 Подходит для алюминиевых профилей под индексом: PA-3731-35-50

ZP-RALUH2-08	H=2	—	—	nikiel nickel plated никель	stal steel сталь



Zawias do ramek aluminiowych, wpuszczany
 Hinge for aluminium frames, inset door
 Петля GTV для алюминиевых рамок, с клипом, внутренняя

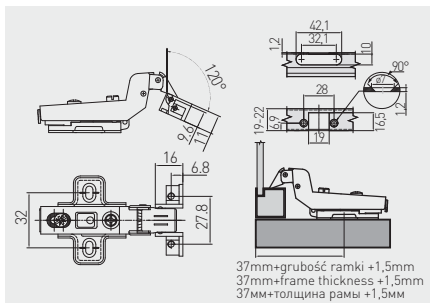

Produkt kompatybilny: profil aluminiowy do frontów: PA-3731-35-50
 Product compatible with aluminum profile for fronts: PA-3731-35-50
 Подходит для алюминиевых профилей под индексом: PA-3731-35-50

ZP-RALUH2-07	H=2	—	—	nikiel nickel plated никель	stal steel сталь



Zawias hydrauliczny do ramek aluminiowych, nakładany
 Hinge for aluminium frame, overlay door
 Петля GTV для алюминиевых рамок, с клипом, накладная

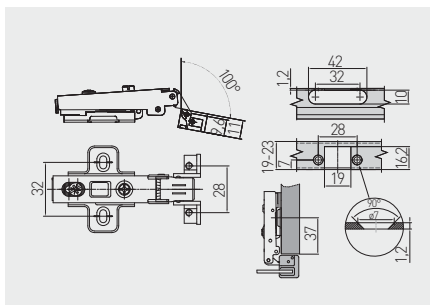

Produkt kompatybilny: profil aluminiowy do frontów: PA-3731-35-50
 Product compatible with aluminum profile for fronts: PA-3731-35-50
 Подходит для алюминиевых профилей под индексом: PA-3731-35-50

ZM-HCRALU9BE	H=0	—	—	nikiel nickel plated никель	stal steel сталь



Zawias 270°, nakładany
Hinge 270°, overlay door
Петля 270°, накладная

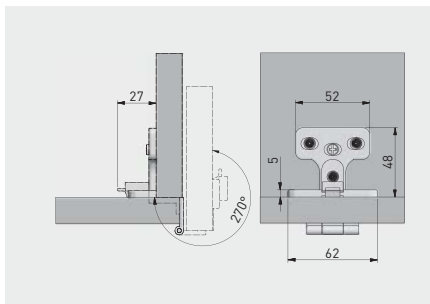

ZP-KT0270-BE	—	—	nikiel nickel никель	ZnAl



Zawias tłoczkowy duży
Cylinder hinge large
Поршневая петля (большая)

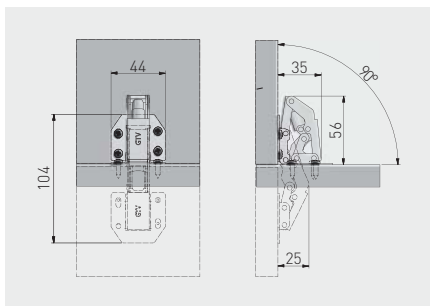





ZT-HF-01-D00	—	—	nikiel nickel никель	stal steel сталь

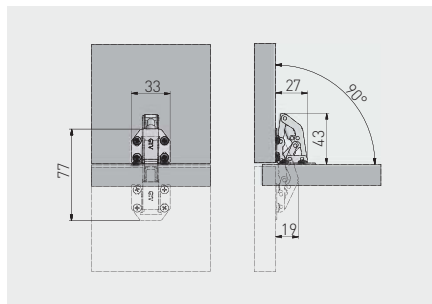

Zawias tłoczkowy mały
Cylinder hinge small
Поршневая петля (малая)







				
ZT-HF-01-M00	—	—	nikiel nickel никель	stal steel сталь

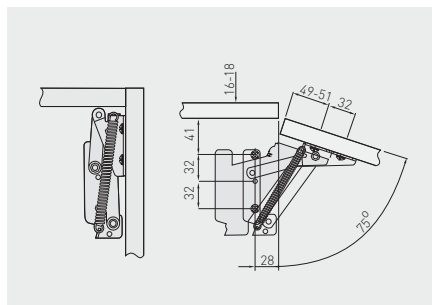

Zawias JUNIOR 75°
JUNIOR hinge 75°
Петля JUNIOR 75°



				
ZP-JUNIOR-00	—	—	nikiel nickel никель	stal steel сталь



Zawias skrzydełkowy
Butterfly hinge
Петля-бабочка

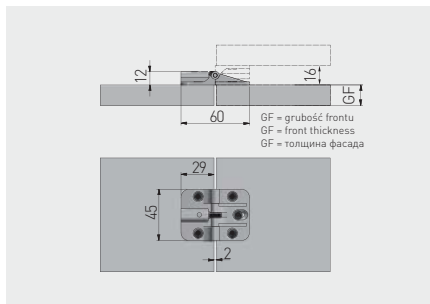

ZP-SKR-00-80	—	—	lakier lacquer лак	szary gray серый	ZnAl



Zawias cylindryczny
Cylinder hinge
Петля цилиндрическая

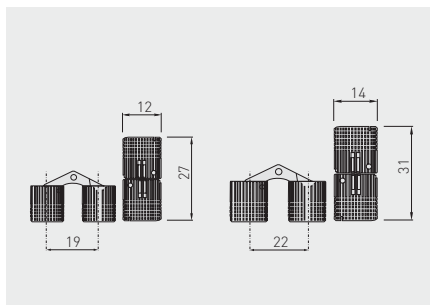

ZC-GTV-12-00	12	7	mosiądz brass латунь	mosiądz brass латунь
ZC-GTV-14-00	14			



Zawias barkowy Flap hinge Барная петля

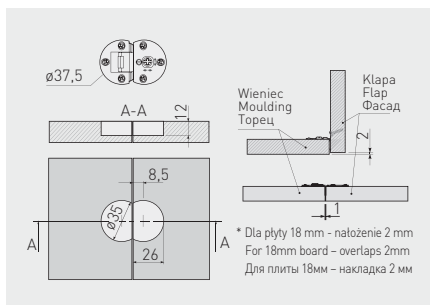

PD-MD-ZB-01-KPL	1 kpl. = 2 szt. 1 set = 2 pcs 1 комп. = 2 шт.	chrom / chrome / хром	ZnAl
PD-MD-ZB-04-KPL		antyczny miedź / antique brass / античная латунь	



Amortyzator z adapterem prostym Buffer with straight adapter Амортизатор с прямым адаптером

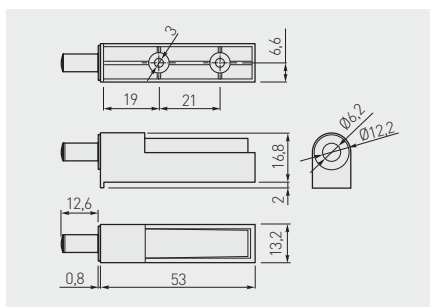

AM-PROST-KPL	szary gray серый	tworzywo plastic пластмасса
--------------	------------------------	-----------------------------------



Amortyzator z adapterem krzyżakowym
Buffer with cross adapter
Амортизатор с крестовым адаптером

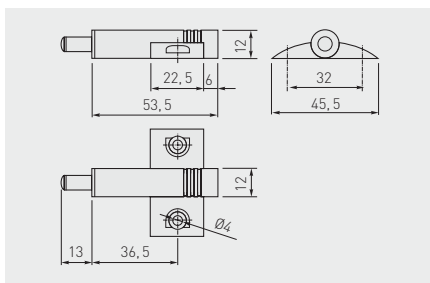

AM-KRZYZ-KPL	szary gray серый	tworzywo plastic пластмасса
--------------	------------------------	-----------------------------------



Amortyzator AM-ODB
Buffer AM-ODB
Амортизатор AM-ODB

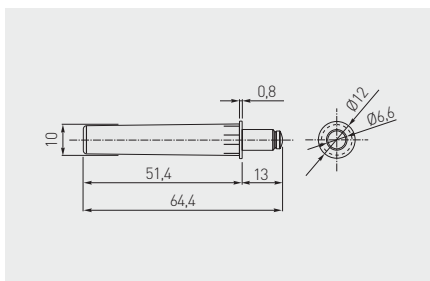

AM-ODB000-60	standard	szary / gray / серый	tworzywo / plastic / пластмасса
AM-ODB000-10		biały / white / белый	



Adapter AM-ODB prosty
 Adapter AM-ODB straight
 Адаптер AM-ODB прямой

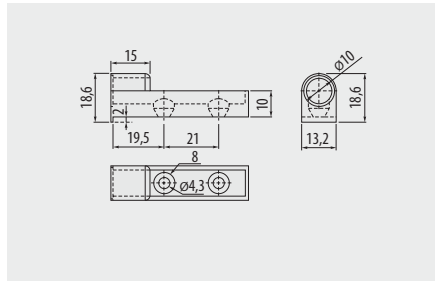

AM-ADAP0B-60	szary / gray / серый	tworzywo / plastic / пластмасса
AM-ADAP0B-10	biały / white / белый	



Adapter AM-ODB krzyżakowy
 Cross adapter AM-ODB
 Адаптер AM-ODB крестовой

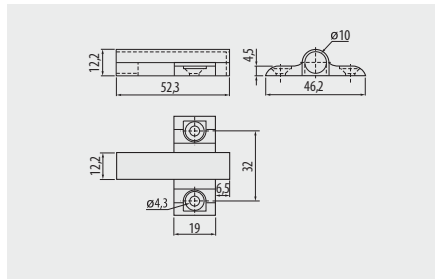

AM-ADAP0A-60	szary / gray / серый	tworzywo / plastic / пластмасса
AM-ADAP0A-10	biały / white / белый	



Odbojnik wpuszczany krótki Bumper, recessed, short Амортизатор врезной короткий

NEW

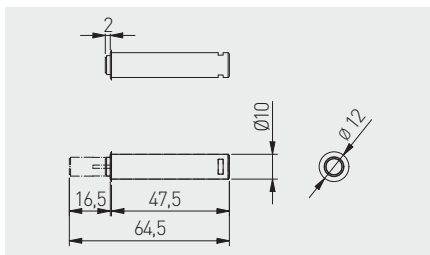

AM-OWM-KR-MG-10	z końcówką magnetyczną / magnetic tip / магнитный наконечник	biały white белый	tworzywo plastic пластмасса
AM-OWM-KR-GM-10	z końcówką kauczukową / with rubber tip / каучуковый наконечник		
AM-OWM-KR-MG-30	z końcówką magnetyczną / magnetic tip / магнитный наконечник	szary gray серый	
AM-OWM-KR-GM-30	z końcówką kauczukową / with rubber tip / каучуковый наконечник		
AM-OWM-KR-MG-60	z końcówką magnetyczną / magnetic tip / магнитный наконечник	antracyt anthracite антрацит	
AM-OWM-KR-GM-60	z końcówką kauczukową / with rubber tip / каучуковый наконечник		



Odbojnik wpuszczany długi Bumper, recessed, long Амортизатор врезной длинный

NEW

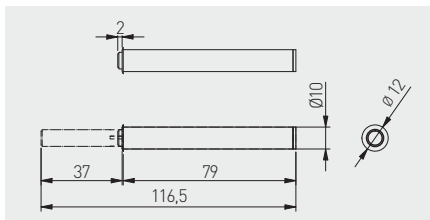

AM-OWM-DL-MG-10	z końcówką magnetyczną / magnetic tip / магнитный наконечник	biały white белый	tworzywo plastic пластмасса
AM-OWM-DL-GM-10	z końcówką kauczukową / with rubber tip / каучуковый наконечник		
AM-OWM-DL-MG-30	z końcówką magnetyczną / magnetic tip / магнитный наконечник	szary gray серый	
AM-OWM-DL-GM-30	z końcówką kauczukową / with rubber tip / каучуковый наконечник		
AM-OWM-DL-MG-60	z końcówką magnetyczną / magnetic tip / магнитный наконечник	antracyt anthracite антрацит	
AM-OWM-DL-GM-60	z końcówką kauczukową / with rubber tip / каучуковый наконечник		



Odbojnik krótki z adapterem Bumper, short, with adapter Амортизатор короткий с адаптером

NEW

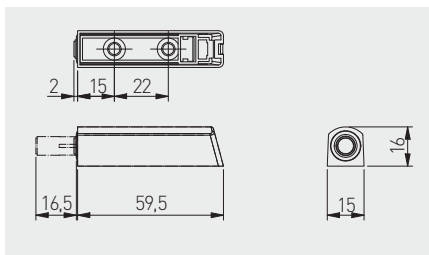

AM-OAM-KR-MG-10	z końcówką magnetyczną / magnetic tip / магнитный наконечник	biały white белый	tworzywo plastic пластмасса
AM-OAM-KR-GM-10	z końcówką kauczukową / with rubber tip / каучуковый наконечник		
AM-OAM-KR-MG-30	z końcówką magnetyczną / magnetic tip / магнитный наконечник	szary gray серый	
AM-OAM-KR-GM-30	z końcówką kauczukową / with rubber tip / каучуковый наконечник		
AM-OAM-KR-MG-60	z końcówką magnetyczną / magnetic tip / магнитный наконечник	antracyt anthracite антрацит	
AM-OAM-KR-GM-60	z końcówką kauczukową / with rubber tip / каучуковый наконечник		



Odbojnik długi z adapterem Bumper, long, with Adapter Амортизатор длинный с адаптером

NEW

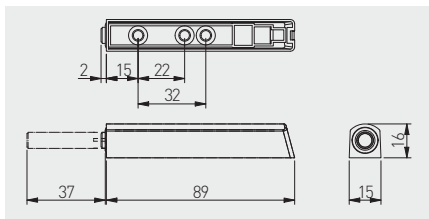

AM-OAM-DL-MG-10	z końcówką magnetyczną / magnetic tip / магнитный наконечник	biały white белый	tworzywo plastic пластмасса
AM-OAM-DL-GM-10	z końcówką kauczukową / with rubber tip / каучуковый наконечник		
AM-OAM-DL-MG-30	z końcówką magnetyczną / magnetic tip / магнитный наконечник	szary gray серый	
AM-OAM-DL-GM-30	z końcówką kauczukową / with rubber tip / каучуковый наконечник		
AM-OAM-DL-MG-60	z końcówką magnetyczną / magnetic tip / магнитный наконечник	antracyt anthracite антрацит	
AM-OAM-DL-GM-60	z końcówką kauczukową / with rubber tip / каучуковый наконечник		



Odbojnik AM-PL z adapterem
Bumper with adapter AM-PL
Амортизатор с адаптером AM-PL

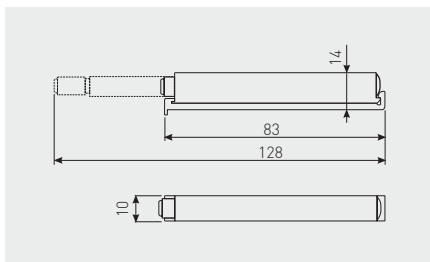

AM-PL-DL-MAG	z końcówką magnetyczną magnetic tip магнитный наконечник	szary gray серый	tworzywo plastic пластмасса
AM-PLA-DLU-0	z końcówką kauczukową with rubber tip каучуковый наконечник		



Odbojnik AM-ZAT zatrzkaskowy
Push latch AM-ZAT
Амортизатор AM-ZAT на защелке

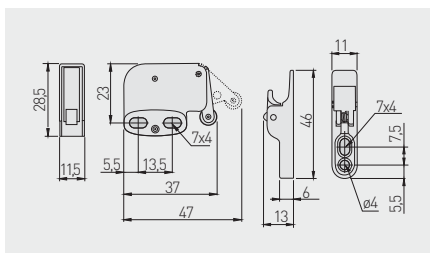

AM-ZAT-A1-10	biały white белый	stal, tworzywo steel, plastic сталь, пластмасса





Do zastosowania z zawiasem samootwierającym ZP-POH045ZE0

Dedicated for GTV self opening hinge ZP-POH045ZE0

Используется с самооткрывающейся петлей ZP-POH045ZE0

Amortyzator silikonowy
Silicone damper dots
Амортизатор силиконовый







	 mm	
AMR-BP-1003	Ø 10 x 3	100 szt. / arkusz 100 pcs / sheet 100 шт. / лист
AMR-BP-0715	Ø 7 x 1,5	

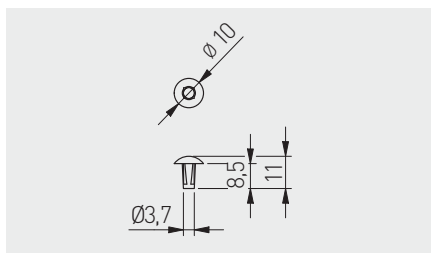

Amortyzator silikonowy wpuszczany
Silicone damper, recessed
Амортизатор силиконовый, врезной

NEW





	 mm	
AMR-WP-00	Ø 5 x 3	silikon silicon кремний

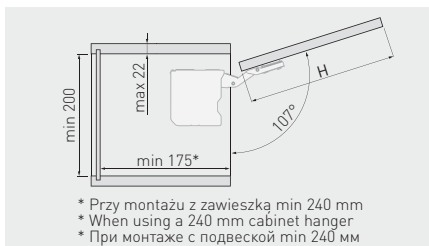

Podnośnik TOP STAYS
TOP STAYS lift
Подъемник TOP STAYS



	Orientacyjna wysokość frontu Approximate front height Ориентировочная высота фасада	Współczynnik F Power Factor F Показатель F	Sprężyna Spring power Пружина		
PD-LIFT-LIGHT-10	250-400 mm	580-1250	light	biały / white / белый	stal steel
PD-LIFT-LIGHT-80				szary / gray / серый	
PD-LIFT-MEDIUM-10	400-500 mm	960-2040	medium	biały / white / белый	
PD-LIFT-MEDIUM-80				szary / gray / серый	
PD-LIFT-STRONG-10	500 mm	1800-3500	strong	biały / white / белый	
PD-LIFT-STRONG-80				szary / gray / серый	



Współczynnik mocy F = wysokość frontu H (mm) × waga frontu łącznie z podwójną wagą uchwytu (kg)

Power Factor F = front height × front weight with doubled handle weight (kg)

Показатель мощности F = высота фасада H (мм) × вес фасада с удвоенным весом ручки (кг)

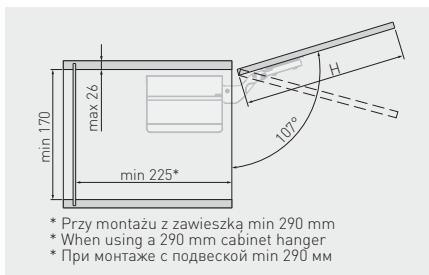
Podnośnik HEAVY DUTY
HEAVY DUTY lift
Подъемник HEAVY DUTY



	Wysokość frontu Front height Высота фасада	Współczynnik F Power Factor F Показатель F		
PD-LIFT-HEAVY_DUTY-10	400-700 mm	3200-9000	biały / white / белый	stal, tworzywo steel, plastic
PD-LIFT-HEAVY_DUTY-80			szary / gray / серый	

Współczynnik mocy F = wysokość frontu H (mm) × waga frontu łącznie z podwójną wagą uchwytu (kg)

Power Factor F = front height H (mm) × front weight with doubled handle weight (kg)

Показатель мощности F = высота фасада H (мм) × вес фасада с удвоенным весом ручки (кг)

Podnośnik gazowy z amortyzatorem i regulacją
 Gas stay with buffer, adjustable
 Подъемник газовый с амортизатором и регулировкой

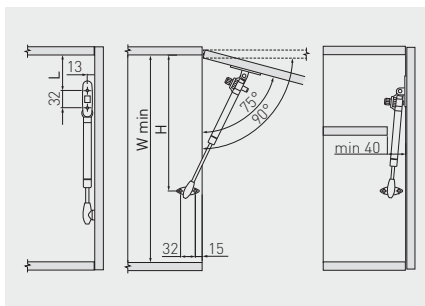

PD-GAM050-N02	50N	szary gray серый	stal steel сталь
PD-GAM060-N02	60N		
PD-GAM080-N02	80N		
PD-GAM100-N02	100N		
PD-GAM120-N02	120N		
PD-GAM150-N02	150N		
PD-GAM050-N10	50N	biały white белый	
PD-GAM060-N10	60N		
PD-GAM080-N10	80N		
PD-GAM100-N10	100N		
PD-GAM120-N10	120N		
PD-GAM150-N10	150N		
PD-GAM050-N60	50N	antracyt anthracite антрацит	
PD-GAM060-N60	60N		
PD-GAM080-N60	80N		
PD-GAM100-N60	100N		
PD-GAM120-N60	120N		
PD-GAM150-N60	150N		

Kąt otwarcia drzwi Door opening angle Угол открывания дверей	H (mm)	L (mm)	W (mm)
75°	295	64	315
90°	275	52	300



Kąt otwarcia drzwi Door opening angle Угол открывания дверей	Siła podnośnika Lift force Мощность подъемника	Wysokość drzwi (mm) / Door height (mm) / Высота дверцы (мм)			
		300	400	500	600
		Waga drzwi (kg) / Door weight (kg) / Вес дверцы (кг)			
75°	50 N	1.6	1.2	1.0	0.8
	60 N	2.0	1.5	1.2	1.0
	80 N	2.7	2.0	1.6	1.4
	100 N	3.4	2.6	2.0	1.7
	120 N	4.1	3.1	2.5	2.0
90°	50 N	1.5	1.1	0.9	0.7
	60 N	1.8	1.3	1.1	0.9
	80 N	2.4	1.8	1.4	1.2
	100 N	3.0	2.2	1.8	1.5
	120 N	3.6	2.7	2.1	1.8
	150 N	4.1	3.2	2.3	2.1

Podnośnik gazowy z amortyzatorem
Gas stay with buffer
Подъемник газовый с амортизатором

NEW



PD-GAMB050-N02	50 N	szary gray серый	stal, tworzywo steel, plastic сталь, пластмасса
PD-GAMB060-N02	60 N		
PD-GAMB080-N02	80 N		
PD-GAMB100-N02	100 N		
PD-GAMB120-N02	120 N		
PD-GAMB150-N02	150 N	biały white белый	
PD-GAMB050-N10	50 N		
PD-GAMB060-N10	60 N		
PD-GAMB080-N10	80 N		
PD-GAMB100-N10	100 N		
PD-GAMB120-N10	120 N		
PD-GAMB150-N10	150 N	antracyt anthracite антрацит	
PD-GAMB050-N60	50 N		
PD-GAMB060-N60	60 N		
PD-GAMB080-N60	80 N		
PD-GAMB100-N60	100 N		
PD-GAMB120-N60	120 N		
PD-GAMB150-N60	150 N		

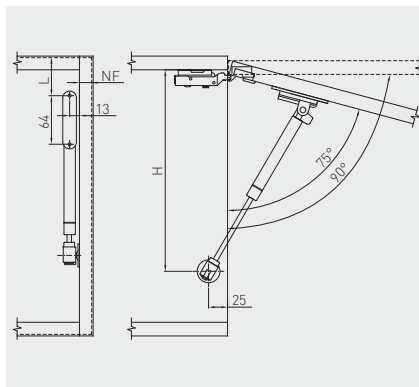

Kąt otwarcia drzwi Door opening angle Угол открывания дверей	H (mm)	L (mm)
75°	265	65
90°	245	50



Kąt otwarcia drzwi Door opening angle Угол открывания дверей	Siła podnośnika Lift force Мощность подъемника	Wysokość drzwi (mm) / Door height (mm) / Высота дверцы (мм)			
		300	400	500	600
		Waga drzwi (kg) / Door weight (kg) / Вес дверцы (кг)			
<p>75°</p>	50 N	1.6	1.2	1.0	0.8
	60 N	2.0	1.5	1.2	1.0
	80 N	2.7	2.0	1.6	1.4
	100 N	3.4	2.6	2.0	1.7
	120 N	4.1	3.1	2.5	2.0
<p>90°</p>	150 N	4.7	3.5	2.9	2.4
	50 N	1.5	1.1	0.9	0.7
	60 N	1.8	1.3	1.1	0.9
	80 N	2.4	1.8	1.4	1.2
	100 N	3.0	2.2	1.8	1.5
	120 N	3.6	2.7	2.1	1.8
	150 N	4.1	3.2	2.3	2.1

*Produkt dostępny na indywidualne zamówienie / Available for special orders / Товар доступен под заказ



80 N

GTV

Podnośnik gazowy standard
 Gas stay lift standard
 Подъемник газовый стандартный



PD-G0050-N02	50 N	szary gray серый	stal steel сталь
PD-G0060-N02	60 N		
PD-G0080-N02	80 N		
PD-G0100-N02	100 N		
PD-G0120-N02	120 N		
PD-G0150-N02	150 N		

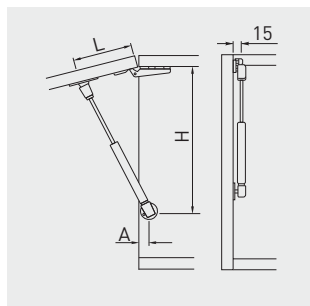

Kąt otwarcia drzwi Door opening angle Угол открывания дверей	Drzwi wpuszczane Inset door Внутренние дверцы			Drzwi bliźniacze Twin door Двойные дверцы			Drzwi nakładane Overlay door Наружные дверцы		
	H (mm)	L (mm)	A (mm)	H (mm)	L (mm)	A (mm)	H (mm)	L (mm)	A (mm)
75°	280	100	20 + grubość frontu 20 + front thickness 20 + толщина фронта	272	100	25	264	100	25
90°	260	90		251	90	25	244	90	25
100°	250	80		242	80	25	234	80	25

Kąt otwarcia drzwi Door opening angle Угол открывания дверей	Siła podnośnika Lift force Мощность подъемника	Wysokość drzwi (mm) / Door height (mm) / Высота дверцы (мм)			
		300	400	500	600
		Waga drzwi (kg) / Door weight (kg) / Вес дверцы (кг)			
75°	60 N	2.0	1.5	1.2	1.0
	80 N	2.7	2.0	1.6	1.4
	100 N	3.4	2.6	2.0	1.7
	120 N	4.1	3.1	2.5	2.0
	150 N	4.7	3.5	2.9	2.4
90°	60 N	1.8	1.3	1.1	0.9
	80 N	2.4	1.8	1.4	1.2
	100 N	3.0	2.2	1.8	1.5
	120 N	3.6	2.7	2.1	1.8
	150 N	4.1	3.2	2.3	2.1
100°	60 N	1.6	1.2	0.9	0.8
	80 N	2.1	1.6	1.2	1.0
	100 N	2.6	1.9	1.6	1.3
	120 N	3.1	2.3	1.9	1.6
	150 N	3.5	2.6	2.2	1.9

Podnośnik MOVE UP gazowy
 Gas stay lift MOVE UP
 Подъемник газовый MOVE UP

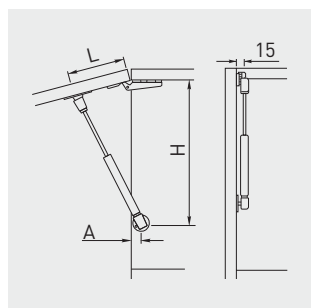

PD-G0050-N10*	50 N	biały white белый	stal steel сталь
PD-G0060-N10	60 N		
PD-G0080-N10	80 N		
PD-G0100-N10*	100 N		
PD-G0120-N10*	120 N	czarny black чёрный	
PD-G0050-N20*	50 N		
PD-G0060-N20	60 N		
PD-G0080-N20	80 N		
PD-G0100-N20*	100 N	antracyt anthracite антрацит	
PD-G0120-N20*	120 N		
PD-G0050-N60	50 N		
PD-G0060-N60	60 N		
PD-G0080-N60	80 N		
PD-G0100-N60	100 N		
PD-G0120-N60	120 N		



Kąt otwarcia drzwi Door opening angle Угол открывания дверей	Drzwi wpuszczane Inset door Внутренние дверцы			Drzwi bliźniacze Twin door Двойные дверцы			Drzwi nakładane Overlay door Наружные дверцы		
	H (mm)	L (mm)	A (mm)	H (mm)	L (mm)	A (mm)	H (mm)	L (mm)	A (mm)
75°	280	100	20 + grubość frontu 20 + front thickness 20 + толщина фронта	272	100	25	264	100	25
90°	260	90		251	90	25	244	90	25
100°	250	80		242	80	25	234	80	25

Kąt otwarcia drzwi Door opening angle Угол открывания дверей	Siła podnośnika Load capacity Мощность подъемника	Wysokość drzwi (mm) / Door height (mm) / Высота дверцы (мм)			
		300	400	500	600
		Waga drzwi (kg) / Door weight (kg) / Вес дверцы (кг)			
75°	60 N	2.0	1.5	1.2	1.0
	80 N	2.7	2.0	1.6	1.4
90°	60 N	1.8	1.3	1.1	0.9
	80 N	2.4	1.8	1.4	1.2
100°	60 N	1.6	1.2	0.9	0.8
	80 N	2.1	1.6	1.2	1.0

*Produkt dostępny na indywidualne zamówienie / Available for special orders / Товар доступен под заказ

Podnośnik gazowy krótki
Gas stay lift short
Подъемник газовый короткий

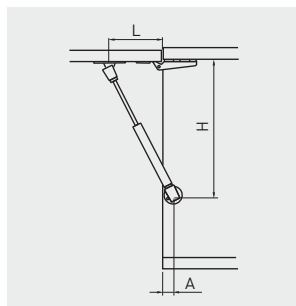

PD-G60160-N02	60 N	szary gray серый	stal steel сталь
PD-G80160-N02	80 N		



Kąt otwarcia drzwi Door opening angle Угол открывания дверей	Drzwi wpuszczane Inset door Внутренние дверцы			Drzwi bliźniacze Twin door Двойные дверцы			Drzwi nakładane Overlay door Наружные дверцы		
	H (mm)	L (mm)	A (mm)	H (mm)	L (mm)	A (mm)	H (mm)	L (mm)	A (mm)
75°	188	70	20 + grubość frontu 20 + front thickness 20 + толщина фронта	180	70	20	172	70	20
90°	176	60		167	60	20	160	60	20
100°	172	50		164	50	20	154	50	20

Kąt otwarcia drzwi Door opening angle Угол открывания дверей	Siła podnośnika Lift force Мощность подъемника	Wysokość drzwi (mm) / Door height (mm) / Высота дверцы (мм)			
		300	400	500	600
		Waga drzwi (kg) / Door weight (kg) / Вес дверцы (кг)			
75° 	60 N	2.0	1.5	1.2	1.0
	80 N	2.7	2.0	1.6	1.4
90° 	60 N	1.8	1.3	1.1	0.9
	80 N	2.4	1.8	1.4	1.2
100° 	60 N	1.6	1.2	0.9	0.8
	80 N	2.1	1.6	1.2	1.0

Podnośnik DESIGN mechaniczny
 Mechanical stay lift DESIGN
 Подъемник механический DESIGN



PD-GPD01-001	chrom / chrome / хром	stal steel сталь
PD-GPD02-002	satyna / satin / сатин	
PD-GPD03-005	aluminium / алюминий	

 Podnośnik do klap
 Flap lift
 Подъемник фасада

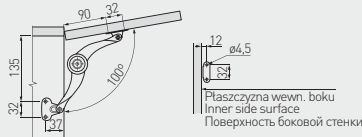

100°

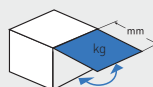
 Wykres orientacyjnych wartości
 maksymalnego ciężaru w zależności
 od wysokości klap.

 Maximum weight depending
 on the flap height

 Максимальный вес фасада зависит
 от его высоты

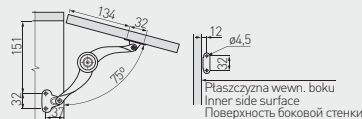
 Podnośnik do klap
 Flap lift
 Подъемник фасада

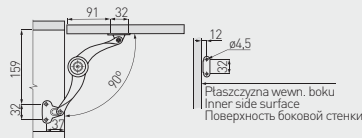

75°

 Podnośnik do klap
 Flap lift
 Подъемник фасада

90°

 Wizualizacja dla zawiasów barkowych
 Drop Down Flap Stay
 Визуализация для барных петель

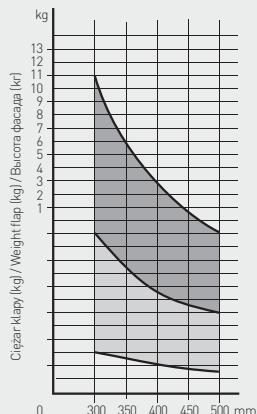
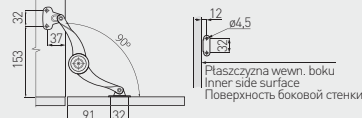
90°

 Wysokość klap (mm)
 Flap height (mm)
 Высота фасада (мм)

 1 podnośnik
 1 stay lift
 1 подъемник

 2 podnośniki
 2 stay lifts
 2 подъемника

Podnośnik mechaniczny standard
 Mechanical stay lift standard
 Подъемник механический стандартный



PD-PD000-001



chrom / chrome / хром



stal / steel / сталь



Podnośnik do klap
 Flap lift
 Поддержка фасада



100°

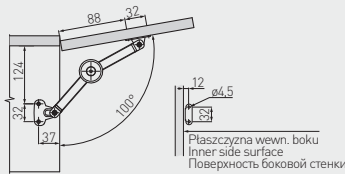

Wykres orientacyjnych wartości maksymalnego ciężaru w zależności od wysokości kłapy.

Maximum weight depending on the flap height.

Максимальный вес фасада зависит от его высоты

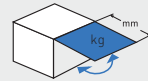

Podnośnik do klap
 Flap lift
 Поддержка фасада



75°

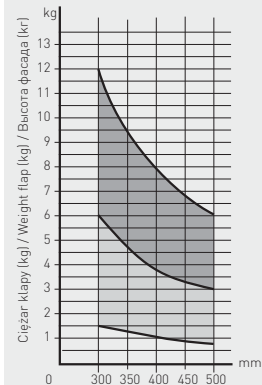
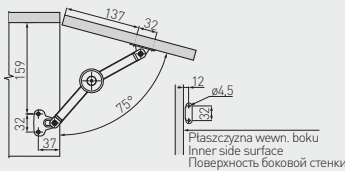

Podnośnik do klap
 Flap lift
 Поддержка фасада



90°

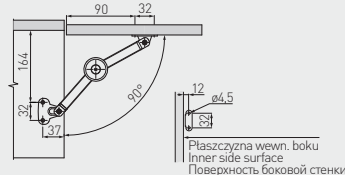

Rozwórka do klap
 Wizualizacja dla zawiasu barkowego
 Drop Down Flap Stay
 Поддержка фасада.
 Визуализация для барных петель



90°

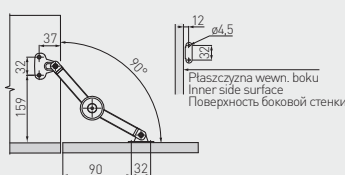

Wysokość kłapy (mm)
 Flap height (mm)
 Высота фасада (mm)

1 podnośnik
 1 stay lift
 1 подъемник

2 podnośniki
 2 stay lifts
 2 подъемника

Amortyzator VIM do klap barkowych, krótki VIM stay lift for drop down cabinet doors - short Амортизатор барный, короткий VIM



Produkt kompatybilny z zawiasem barkowym: PD-MD-ZB

Compatible with flap hinge: PD-MD-ZB

Продукт совместим с барной петлей: PD-MD-ZB



PD-MDLIFT-P1-D



szary
gray
серый



stal
steel
сталь



Orientacyjna tabela wartości doboru podnośników, w zależności od szerokości i wysokości kłapy.
Maximum weight depending on the flap height.

Таблица подбора амортизатора в зависимости от ширины и высоты фасада.

Wysokość Height Высота	Szerokość [mm] / Width [mm] / Ширина [мм]			
	600 mm	700 mm	800 mm	900 mm
Ilość amortyzatorów Number of lifts Количество амортизаторов				
250 mm	1	1	2	2
260 mm				
270 mm				
280 mm		2		
290 mm				
300 mm	2	2	2	
310 mm				
320 mm				
330 mm				
340 mm				

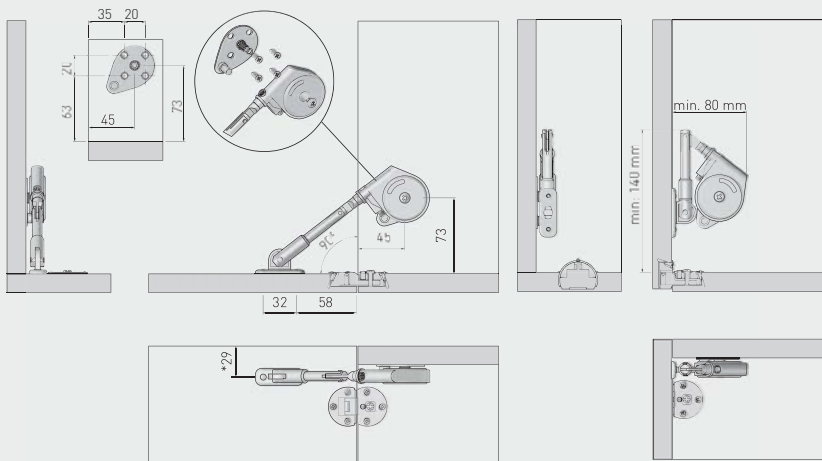

* Przy pełnym nateżeniu na korpus # 18 mm

* When fully applied to the cabinet # 18 mm

* При полном соприкосновении с внутренней поверхностью стенки корпуса 18 мм

Amortyzator VIM do klap barkowych, długi
 VIM stay lift for drop down cabinet doors - long
 Амортизатор барный VIM, длинный



Produkt kompatybilny z zawiasem barkowym: PD-MD-ZB

Compatible with flap hinge: PD-MD-ZB

Продукт совместим с барной петлей: PD-MD-ZB

		
PD-MDLIFT-P2-D	szary gray серый	stal steel сталь



Orientacyjna tabela wartości doboru podnośników, w zależności od szerokości i wysokości kłapy. Maximum weight depending on the flap height. Таблица подбора амортизатора в зависимости от ширины и высоты фасада.

Wysokość Height Высота	Szerokość / Width / Ширина			
	600 mm	700 mm	800 mm	900 mm
	Ilość amortyzatorów Number of lifts Количество амортизаторов			
350 mm	1	2	2	2
360 mm				
370 mm				
380 mm				
390 mm				
400 mm				

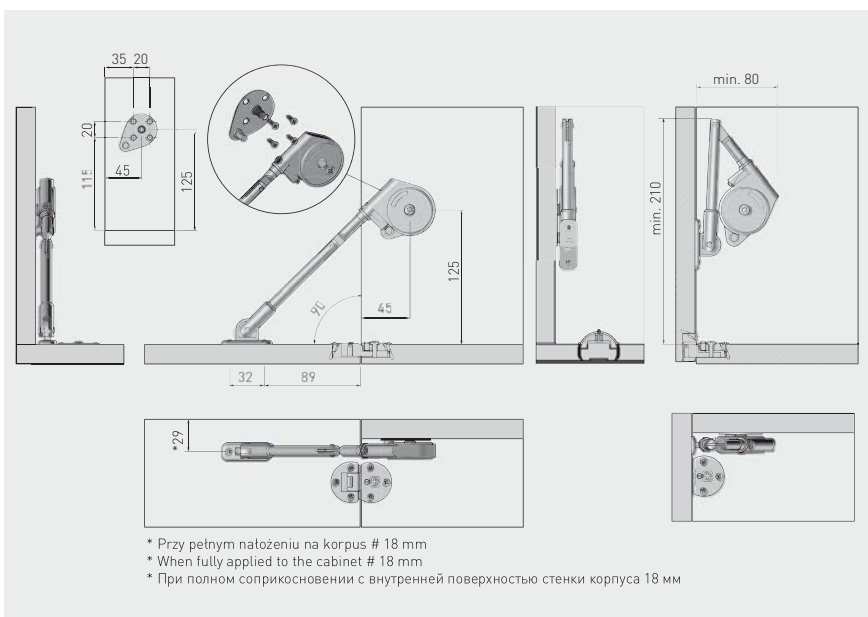

Amortyzator olejowy do klap barkowych
Oil stay lift for drop down cabinet doors
Амортизатор маслянный барный

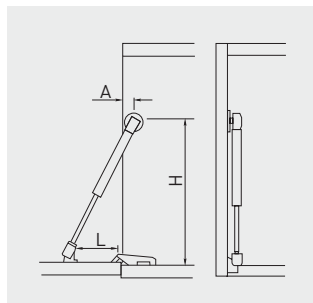

PD-ECGDL-060	60 N	szary gray серый	stal steel сталь
PD-ECGDL-080	80 N		
PD-ECGDL-150	150 N		



Kąt otwarcia drzwi Door opening angle Угол открывания дверей	Drzwi wpuszczane Inset door Внутренние двери			Drzwi bliźniacze Twin door Двойные двери			Drzwi nakładane Overlay door Наружные двери		
	H (mm)	L (mm)	A (mm)	H (mm)	L (mm)	A (mm)	H (mm)	L (mm)	A (mm)
90°	260	90	45	253	90	25	246	90	25

Kąt otwarcia drzwi Door opening angle Угол открывания дверей	Siła podnośnika Lift force Мощность подъемника	Wysokość drzwi (mm) / Door height (mm) / Высота двери (мм)			
		300	400	500	600
		Waga drzwi (kg) / Door weight (kg) / Вес двери (кг)			
 90°	60 N	1.8	1.3	1.1	0.9
	80 N	2.4	1.8	1.4	1.2
	150 N	4.1	3.2	2.3	2.1

Prowadnica dolnego montażu ze spowalniczem 0SHX
 Undermount drawer slide with soft closing 0SHX
 Направляющая нижнего монтажа полного выдвижения с доводчиком 0SHX



Rozstaw otworów montażowych
 Mounting dimensions
 Монтажные отверстия

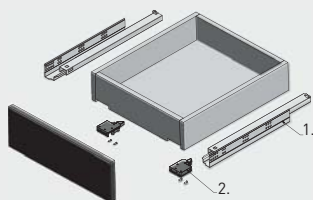
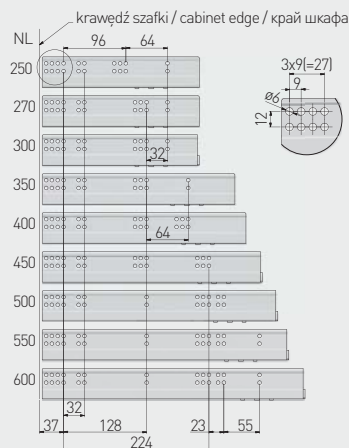

1. prowadnica lewa/prawa
 drawer slide L/R
 направляющая Л/П
2. sprzęgło lewe/prawe + wkręty
 locking device L/R + screws
 крепление фасада Л/П + саморезы

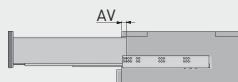

NL = długość nominalna prowadnicy
 nominal slide length
 номинальная длина направляющей

AV = strata wysuwu
 extension loss
 потеря на выдвижении

Uwagi montażowe: dla prawidłowego działania szuflady jej szerokość nie może przekraczać długości nominalnej prowadnicy.
 Mounting information: for proper drawer operation, the width of the drawer can not exceed the nominal slide length.
 Техническое примечание: ширина ящика не должна превышать длину направляющей.

	L mm	AV mm			
PB-0SHX-250-A	250	16	pełny full полное	35	ocynk galvanized гальваника
PB-0SHX-270-A	270				
PB-0SHX-300-A	300				
PB-0SHX-350-A	350				
PB-0SHX-400-A	400				
PB-0SHX-450-A	450				
PB-0SHX-500-A	500				
PB-0SHX-550-A	550				
PB-0SHX-600-A	600				



Prowadnica dolnego montażu ze spowalniczem 0SHX-18
 Undermount drawer slide with soft closing 0SHX-18
 Направляющая нижнего монтажа с доводчиком 0SHX-18



Rozstaw otworów montażowych
 Mounting dimensions
 Монтажные отверстия

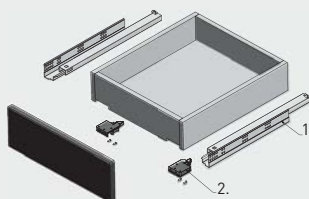
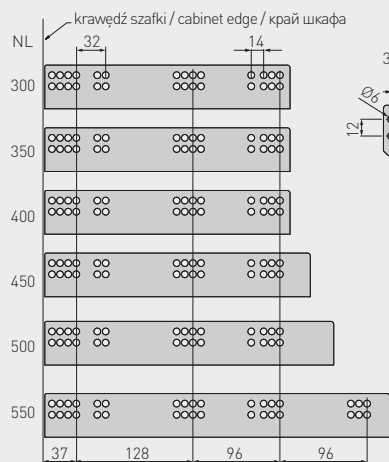

1. prowadnica lewa/prawa
 drawer slide L/R
 направляющая Л/П
2. sprzeczko lewe/prawe + wkręty
 locking device L / R + screws
 крепление фасада Л/П + саморезы

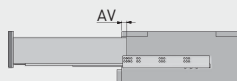

NL = długość nominalna prowadnicy
 nominal slide length
 номинальная длина направляющей

AV = strata wysuwu
 extension loss
 потеря на выдвигании

Uwagi montażowe: dla prawidłowego działania szuflady jej szerokość nie może przekraczać długości nominalnej prowadnicy.
 Mounting information: for proper drawer operation, the width of the drawer can not exceed the nominal slide length.
 Техническое примечание: ширина ящика не должна превышать длину направляющей.

Model	L (mm)	AV (mm)	Width	Weight (kg)	Finish	Material
PB-0SHX18-300-H	300	16	pełny / full	30	ocynk galwanizowany / galvanized	stal / steel
PB-0SHX18-350-H	350					
PB-0SHX18-400-H	400					
PB-0SHX18-450-H	450					
PB-0SHX18-500-H	500					
PB-0SHX18-550-H	550					



Prowadnica dolnego montażu ze spowalniczem 0SHX-18 3D
 Undermount drawer slide with soft closing 0SHX-18 3D
 Направляющая нижнего монтажа с доводчиком 0SHX-18 3D



NL krawędź szafki / cabinet edge / край шкафа

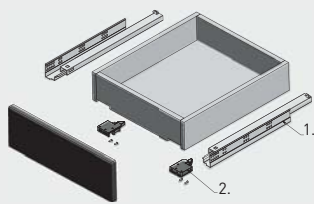
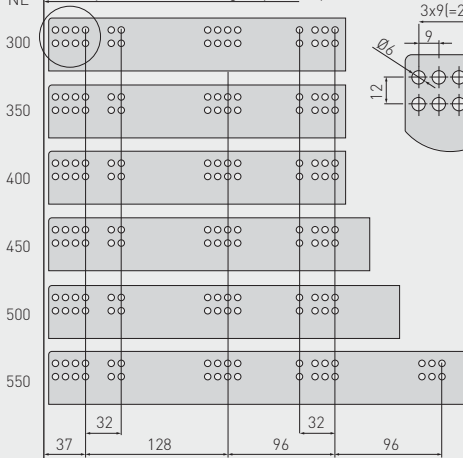

1. prowadnica lewa/prawa
drawer slide L/R
направляющая Л/П
2. sprężęto lewe/prawe + wkręty
locking device L/R + screws
крепления фасада Л/П + саморезы

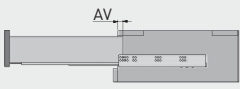

NL = długość nominalna prowadnicy
nominal slide length
номинальная длина направляющей
AV = strata wysuwu
extension loss
потеря на выдвижении

Uwagi montażowe: dla prawidłowego działania szuflady jej szerokość nie może przekraczać długości nominalnej prowadnicy.
 Mounting information: for proper drawer operation, the width of the drawer can not exceed the nominal slide length.
 Техническое примечание: ширина ящика не должна превышать длину направляющей.

	L mm	AV mm		kg		
PB-3D0SHX18-300-H	300	16	pełny full полное	30	ocynk galvanized гальваника	stal steel сталь
PB-3D0SHX18-350-H	350					
PB-3D0SHX18-400-H	400					
PB-3D0SHX18-450-H	450					
PB-3D0SHX18-500-H	500					
PB-3D0SHX18-550-H	550					



Prowadnica dolnego montażu ze spowalniczem GCHX
 Undermount drawer slide with soft closing GCHX
 Направляющая нижнего монтажа неполного выдвижения с доводчиком GCHX

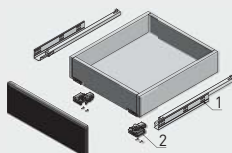
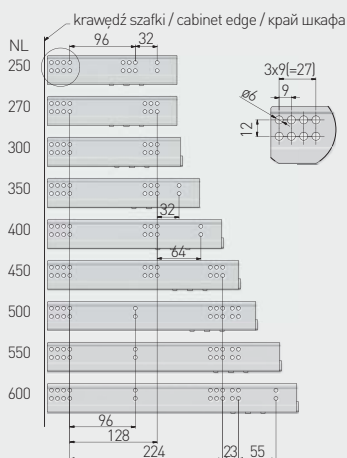







1. prowadnica lewa/prawa
drawer slide L/R
направляющая Л/П
2. sprzężenie lewe/prawe + wkręty
locking device L/R + screws
крепления фасада Л/П + саморезы



NL = długość nominalna prowadnicy
nominal slide length
номинальная длина направляющей

AV = strata wysuwu
extension loss
потеря на выдвижении

Uwagi montażowe: dla prawidłowego działania szuflady jej szerokość nie może przekraczać długości nominalnej prowadnicy.
 Mounting information: for proper drawer operation, the width of the drawer can not exceed the nominal slide length.
 Техническое примечание: ширина ящика не должна превышать длину направляющей.

		 L mm	 AV mm				
PB-GCHX-250		250	98,5		25	ocynk galvanized	stal steel
PB-GCHX-270		270					
PB-GCHX-300		300					
PB-GCHX-350		350	118,5	niepełny partial неполное		ocynk galvanized	stal steel
PB-GCHX-400		400					
PB-GCHX-450		450					
PB-GCHX-500		500	138,5			ocynk galvanized	stal steel
PB-GCHX-550		550					
PB-GCHX-600		600					



Prowadnica dolnego montażu ze spowalniczem GCHX-H
 Undermount drawer slide with soft closing GCHX-H
 Направляющая нижнего монтажа неполное выдвижение с доводчиком GCHX-H

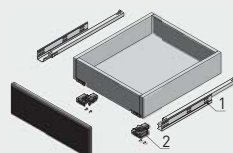
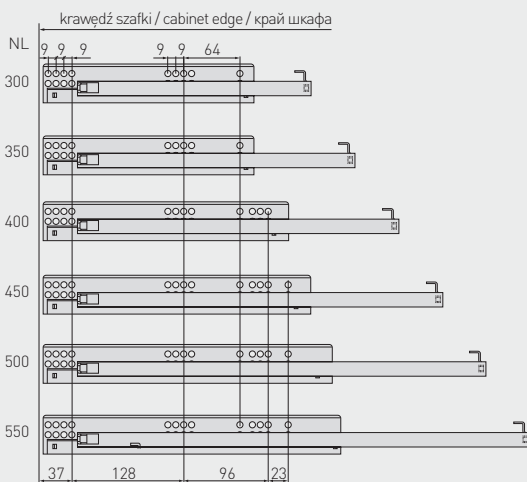



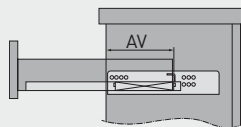



1. prowadnica lewa/prawa
drawer slide L/R
направляющая Л/П
2. sprzętło lewe/prawe + wkrety
locking device L/R + screws
крепления фасада Л/П + саморезы



NL = długość nominalna prowadnicy
nominal slide length
номинальная длина направляющей

AV = strata wysuwu
extension loss
потеря на выдвижении





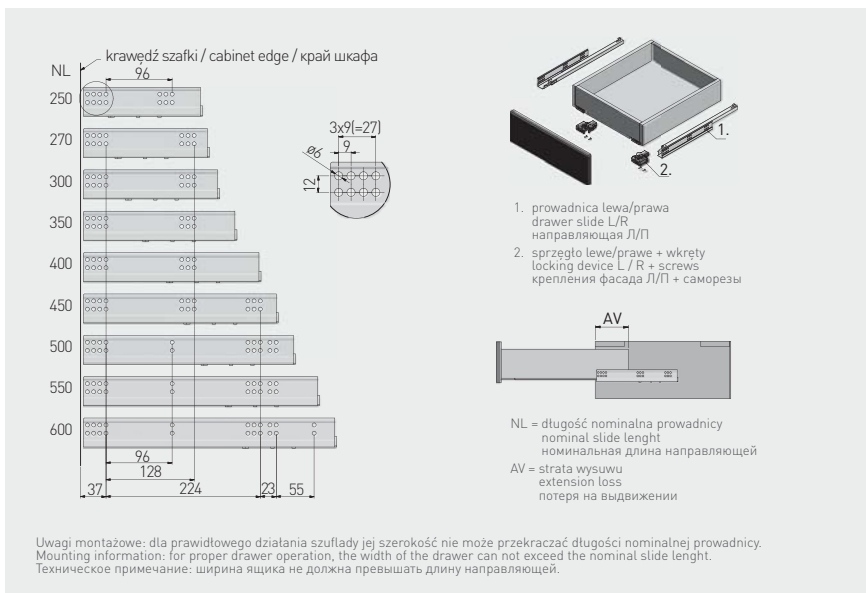

Uwagi montażowe: dla prawidłowego działania szuflady jej szerokość nie może przekraczać długości nominalnej prowadnicy.
 Mounting information: for proper drawer operation, the width of the drawer can not exceed the nominal slide length.
 Техническое примечание: ширина ящика не должна превышать длину направляющей.

	 L mm	 AV mm		 kg		
PB-GCHX-300-H	300	83	niepełny partial неполное	30	ocynk galvanized гальваника	stal steel сталь
PB-GCHX-350-H	350					
PB-GCHX-400-H	400					
PB-GCHX-450-H	450					
PB-GCHX-500-H	500					
PB-GCHX-550-H	550					



Prowadnica dolnego montażu push to open GAPO
 Undermount drawer slide push to open GAPO
 Направляющая нижнего монтажа неполное выдвижение push to open GAPO



		 L mm	 AV mm		 kg		
PB-GAPO-250		250	98,5	niepełny partial неполное	25	ocynk galvanized гальваника	stal steel сталь
PB-GAPO-270		270					
PB-GAPO-300		300					
PB-GAPO-350		350	118,5				
PB-GAPO-400		400					
PB-GAPO-450		450					
PB-GAPO-500		500	138,5				
PB-GAPO-550		550					
PB-GAPO-600		600					



Prowadnica dolnego montażu push to open 0FPO
 Undermount drawer slide push to open 0FPO
 Направляющая нижнего монтажа push to open 0FPO





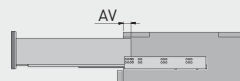
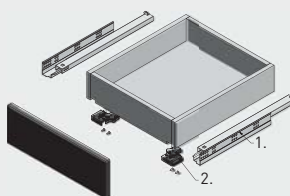
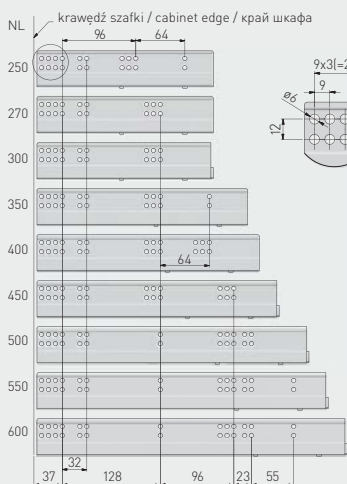



Możliwość zastosowania stabilizatora PB-D-P20STAB
 Can be used with stabilizer PB-D-P20STAB
 Возможность использования стабилизатора PB-D-P20STAB



NL = długość nominalna prowadnicy
 nominal slide length
 номинальная длина направляющей
 AV = strata wysuwu
 extension loss
 потеря на выдвигении

Uwagi montażowe: dla prawidłowego działania szuflady jej szerokość nie może przekraczać długości nominalnej prowadnicy.
 Mounting information: for proper drawer operation, the width of the drawer can not exceed the nominal slide length.
 Техническое примечание: ширина ящика не должна превышать длину направляющей.

	 L mm	 AV mm		 kg		
PB-0FPO-250	250	26	pełny full полное	25	ocynk galvanized гальваника	stal steel сталь
PB-0FPO-270	270					
PB-0FPO-300	300					
PB-0FPO-350	350					
PB-0FPO-400	400					
PB-0FPO-450	450					
PB-0FPO-500	500					
PB-0FPO-550	550					
PB-0FPO-600	600					



Prowadnica dolnego montażu ze spowalniczem S10C
 Undermount drawer slide with soft closing S10C
 Направляющая нижнего монтажа с доводчиком S10C



Kotek blokujący (zabezpieczenie przed wypadnięciem szuflady)

Blocking peg (prevents drawer from falling out)

Ограничитель (защита от выпадения ящика)

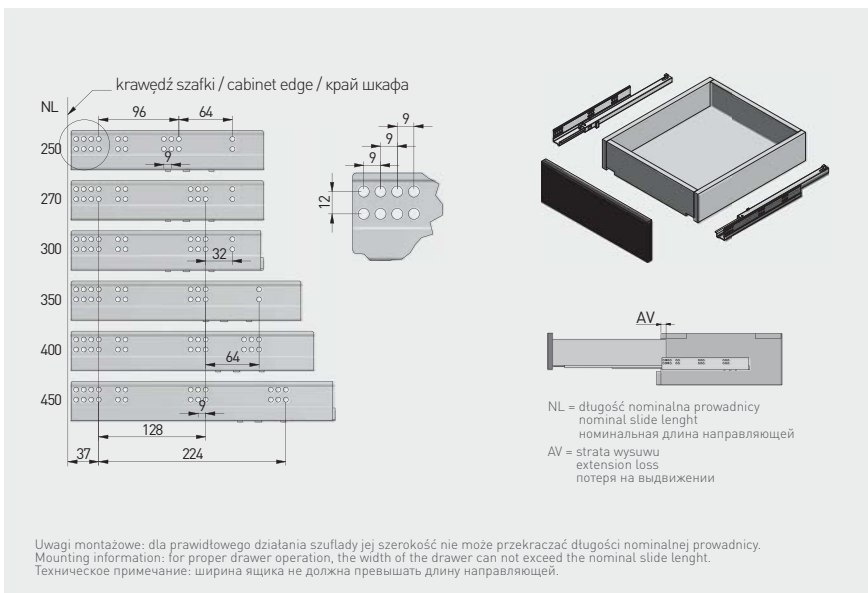

	 L mm	 AV mm		 kg		
PB-S10C300HX	300	28	petny full полное	25	ocynk galvanized гальваника	stal steel сталь
PB-S10C350HX	350					
PB-S10C400HX	400					
PB-S10C450HX	450					



Prowadnice dolnego montażu ze spowalniczem G10HX
 Undermount drawer slide with soft closing G10HX
 Направляющая нижнего монтажа неполное выдвижение с доводчиком G10HX



Kotek blokujący (zabezpieczenie przed wypadnięciem szuflady)

Blocking peg (prevents drawer from falling out)

Ограничитель (защита от выпадения ящика)

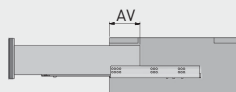
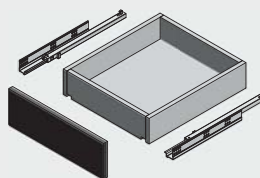
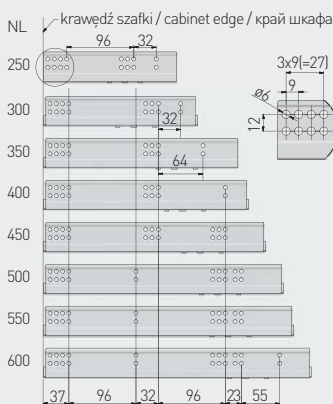

NL = długość nominalna prowadnicy
 nominal slide length
 номинальная длина направляющей
 AV = strata wysuwu
 extension loss
 потеря на выдвижении

Uwagi montażowe: dla prawidłowego działania szuflady jej szerokość nie może przekraczać długości nominalnej prowadnicy.
 Mounting information: for proper drawer operation, the width of the drawer can not exceed the nominal slide length.
 Техническое примечание: ширина ящика не должна превышать длину направляющей.









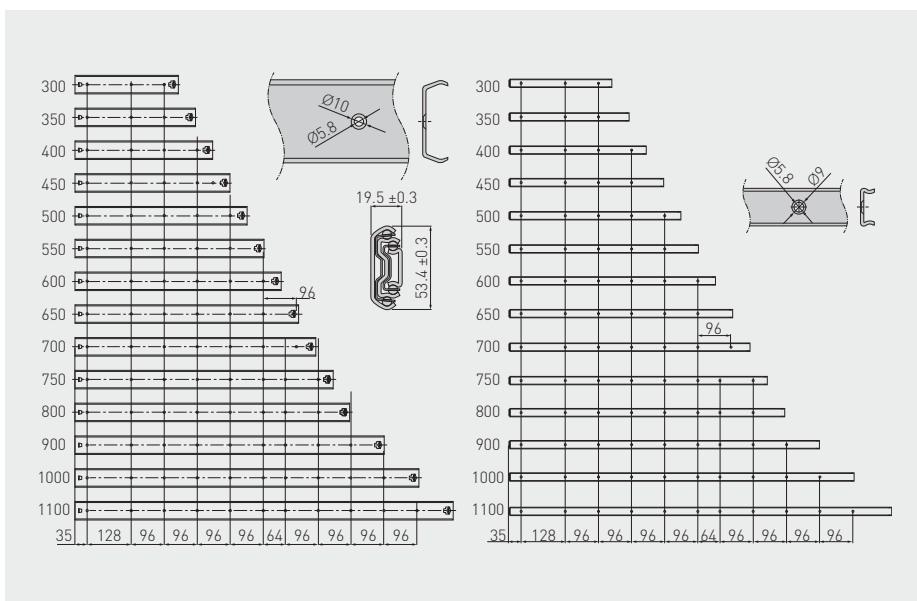

	L mm	AV mm		kg T		
PB-G10HX250	250	86,5	niepełny partial неполное	25	ocynk galvanized гальваника	stal steel сталь
PB-G10HX300	300					
PB-G10HX350	350					
PB-G10HX400	400					
PB-G10HX450	450					
PB-G10HX500	500					
PB-G10HX550	550					
PB-G10HX600	600	126,5				





Prowadnica kulkowa H53
 Ball bearing slide H53
 Шариковая направляющая H53









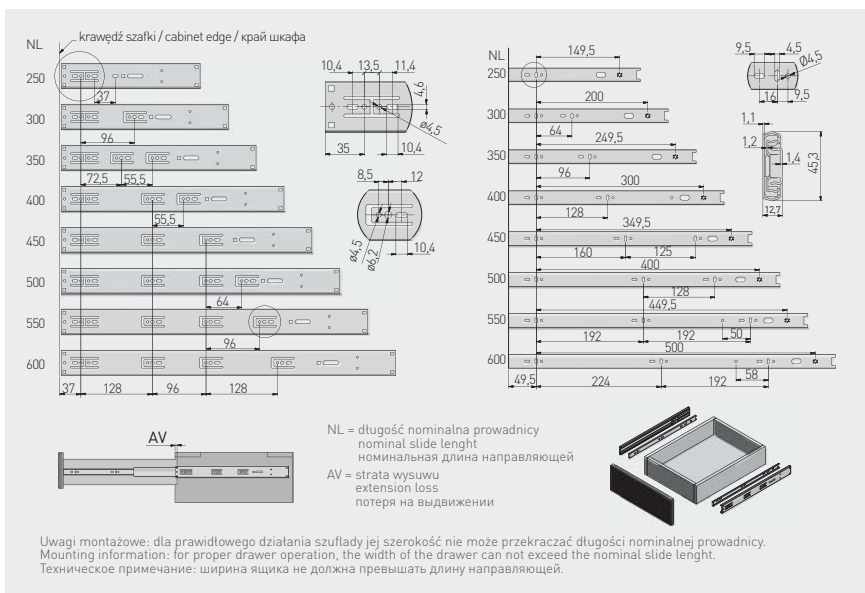

		 L mm	 AV mm	 kg					 L mm	 AV mm	 kg					
PK-0-H53-300		300	-					PK-0-H53-650	650	-						
PK-0-H53-350		350	-					PK-0-H53-700	700	-						
PK-0-H53-400		400	-	petny full полное	100	ocynk galvanized гальваника	stal steel сталь	PK-0-H53-750	750	-						
PK-0-H53-450		450	-					PK-0-H53-800	800	-						
PK-0-H53-500		500	-					PK-0-H53-900	900	-						
PK-0-H53-550		550	-					PK-0-H53-1000	1000	-						
PK-0-H53-600		600	-					PK-0-H53-1100	1100	-						





Prowadnica kulkowa VERSALITE PLUS ze spowalniczem H45
 Ball bearing slide VERSALITE PLUS with soft closing H45
 Шариковая направляющая VERSALITE PLUS с доводчиком H45









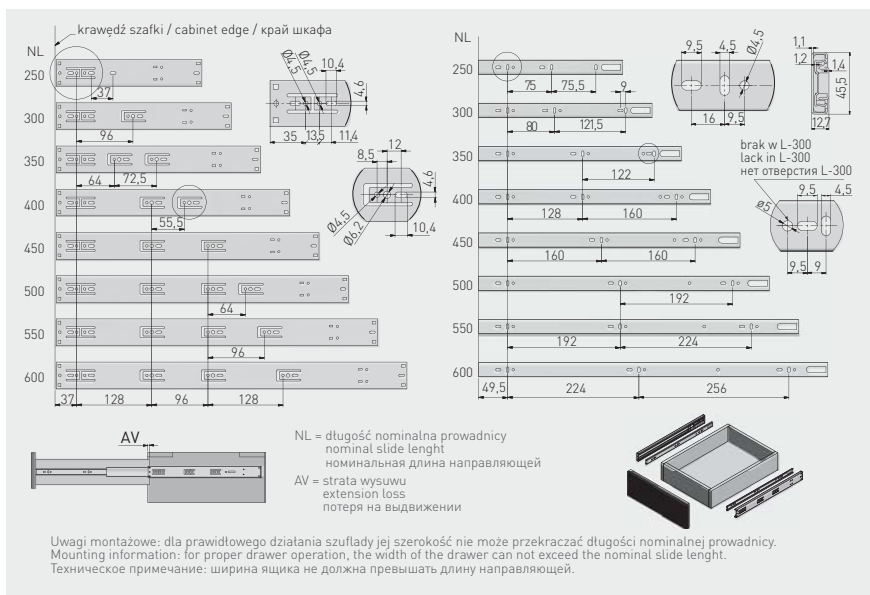

	 L mm	 AV mm				
PK-L-H45-250	250*	102	petny full полное	30	ocynk galvanized гальваника	stal steel сталь
PK-L-H45-300	300*	52				
PK-L-H45-350	350*	35				
PK-L-H45-400	400*	20				
PK-L-H45-450	450	4				
PK-L-H45-500	500					
PK-L-H45-550	550					
PK-L-H45-600	600					

* Brak pełnego wysuwu / Not full extension / Неполное выдвигение



Prowadnica kulkowa VERSALITE ze spowalniczem H45*
 Ball bearing slide VERSALITE with soft closing H45*
 Шариковая направляющая VERSALITE с доводчиком H45*



		 L mm	 AV mm		 kg		
PK-L-H45-250-A		250**	55	pełny full полное	30	ocynk galvanized гальванка	stal steel сталь
PK-L-H45-300-A		300	15				
PK-L-H45-350-A		350	5				
PK-L-H45-400-A		400					
PK-L-H45-450-A		450					
PK-L-H45-500-A		500	0				
PK-L-H45-550-A		550					
PK-L-H45-600-A		600					





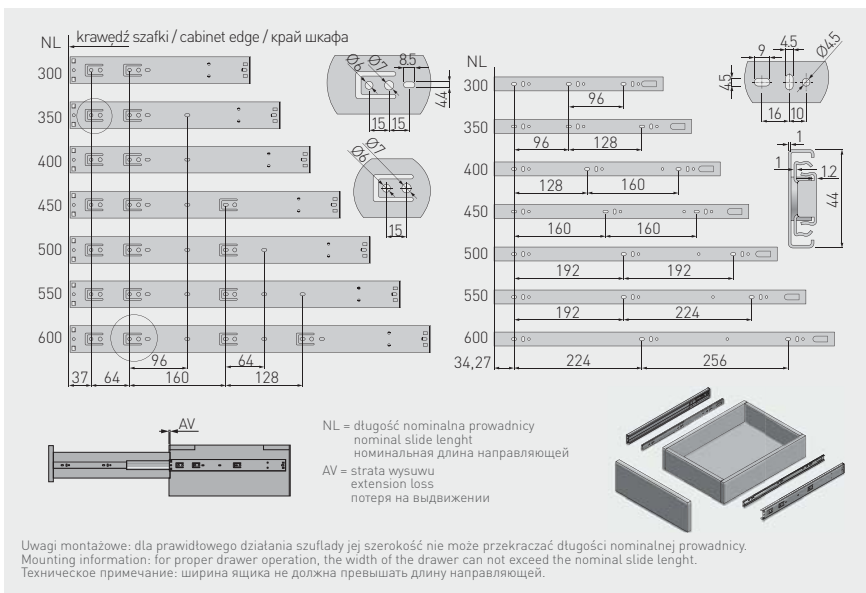

*Produkt dostępny na indywidualne zamówienie / Available for special orders / Товар доступен под заказ

** Brak pełnego wysuwu / Not full extension / Неполное выдвижение



Prowadnica kulkowa VERSALITE LIGHT ze spowalniaczem H45
 Ball bearing slide VERSALITE LIGHT with soft closing H45
 Шариковая направляющая VERSALITE LIGHT с доводчиком H45



		 L mm	 AV mm				
	PK-L-H45-300-GX	300	50	pełny full полное	25	ocynk galvanized гальваника	stal steel сталь
	PK-L-H45-350-GX	350	20				
	PK-L-H45-400-GX	400	-				
	PK-L-H45-450-GX	450	-				
	PK-L-H45-500-GX	500	-				
	PK-L-H45-550-GX	550	-				
	PK-L-H45-600-GX	600	-				



Prowadnica kulkowa z samodociąganiem H45*
 Ball bearing slide with self closing H45*
 Шариковая направляющая с фиксатором H45*

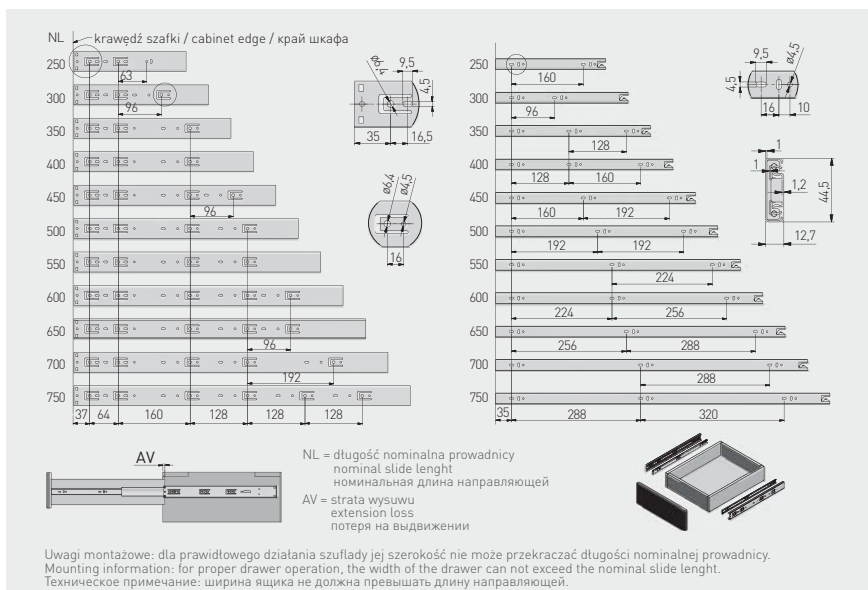

	L mm	AV mm		kg			
PK-S-H45-250	250**	22	pełny full полное	35	ocynk galvanized гальваника	stal steel сталь	15
PK-S-H45-300	300						
PK-S-H45-350	350						
PK-S-H45-400	400						
PK-S-H45-450	450						
PK-S-H45-500	500						
PK-S-H45-550	550						10
PK-S-H45-600	600						
PK-S-H45-650	650						
PK-S-H45-700	700						

*Produkt dostępny na indywidualne zamówienie / Available for special orders / Товар доступен под заказ
 ** Brak pełnego wysuwu / Not full extension / Неполное выдвижение



Prowadnica kulkowa push to open H45
 Ball bearing slide push to open H45
 Шариковая направляющая push to open H45



Możliwość zastosowania stabilizatora PB-D-P20STAB

Can be used with stabilizer PB-D-P20STAB

Возможность использования стабилизатора PB-D-P20STAB

NL krawędź szafki / cabinet edge / край шкафа

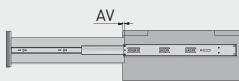
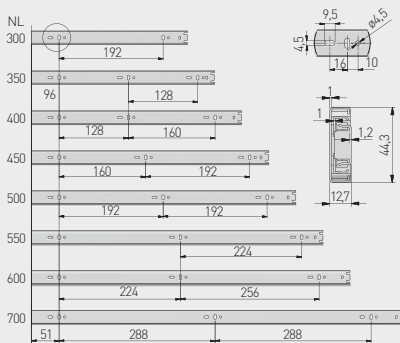
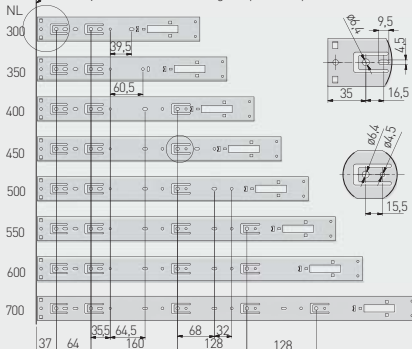

NL = długość nominalna prowadnicy
 nominal slide length
 номинальная длина направляющей
 AV = strata wysuwu
 extension loss
 потеря на выдвигении

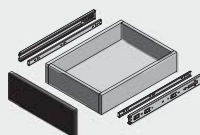

Uwagi montażowe: dla prawidłowego działania szuflady jej szerokość nie może przekraczać długości nominalnej prowadnicy.
 Mounting information: for proper drawer operation, the width of the drawer can not exceed the nominal slide length.
 Техническое примечание: ширина ящика не должна превышать длину направляющей.

	L mm	AV mm		kg			
PK-P-0H45-300A	300*	20	pełny full полное	25	ocynk galvanized гальваника	stal steel сталь	15
PK-P-0H45-350A	350						
PK-P-0H45-400A	400						
PK-P-0H45-450A	450						
PK-P-0H45-500A	500						
PK-P-0H45-550A	550						
PK-P-0H45-600A	600	10					
PK-P-0H45-700A	700						

* Brak pełnego wysuwu / Not full extension / Неполное выдвигение



Prowadnica kulkowa push to open H45 GX
 Ball bearing slide push to open H45 GX
 Шариковая направляющая push to open H45 GX







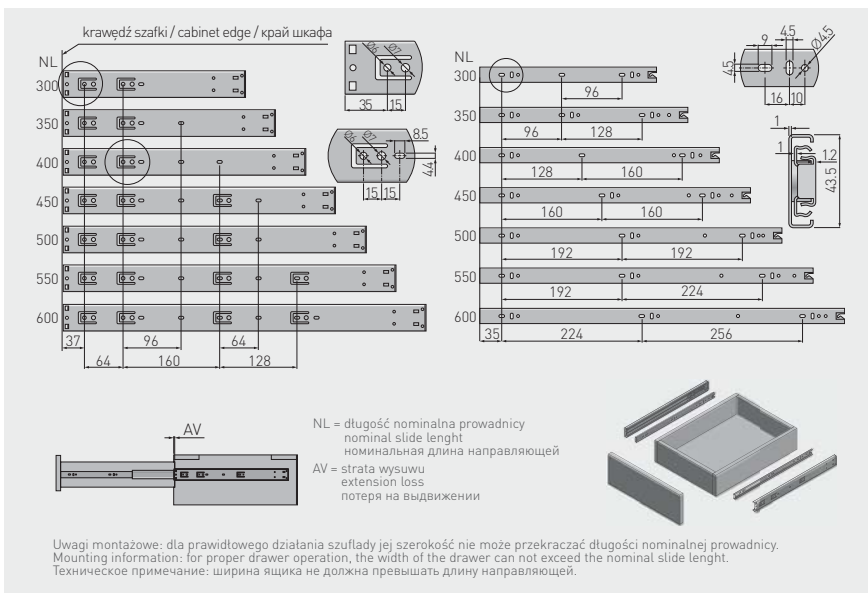

Możliwość zastosowania stabilizatora PB-D-P20STAB

Can be used with stabilizer PB-D-P20STAB

Возможность использования стабилизатора PB-D-P20STAB









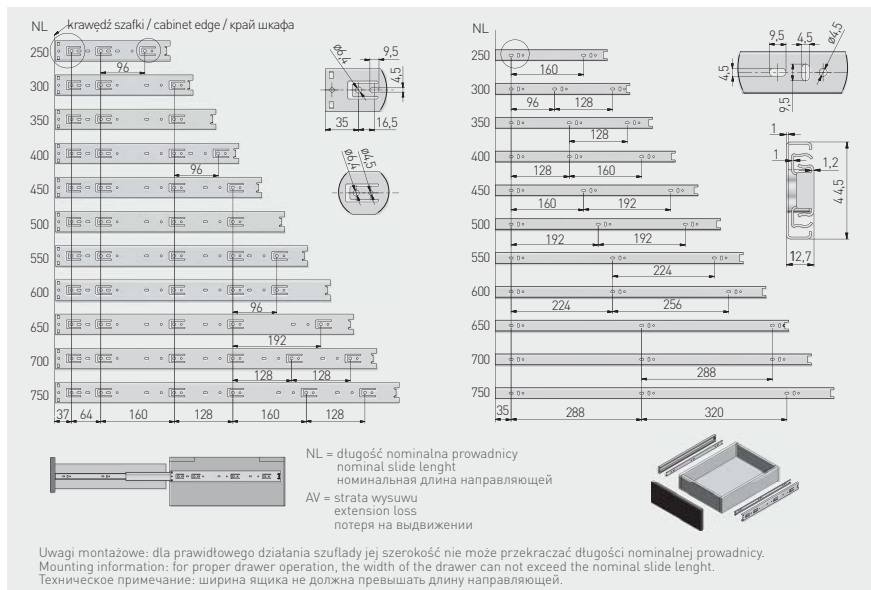

		 L mm	 AV mm		 kg		
PK-P-H45-300-GX		300	30	petny full полное	25	ocynk galvanized гальваника	stal steel сталь
PK-P-H45-350-GX		350					
PK-P-H45-400-GX		400					
PK-P-H45-450-GX		450					
PK-P-H45-500-GX		500					
PK-P-H45-550-GX		550					
PK-P-H45-600-GX		600					



Prowadnica kulkowa H45 PRESTIGE
Ball bearing slide H45 PRESTIGE
Шариковая направляющая H45 RESTIGE







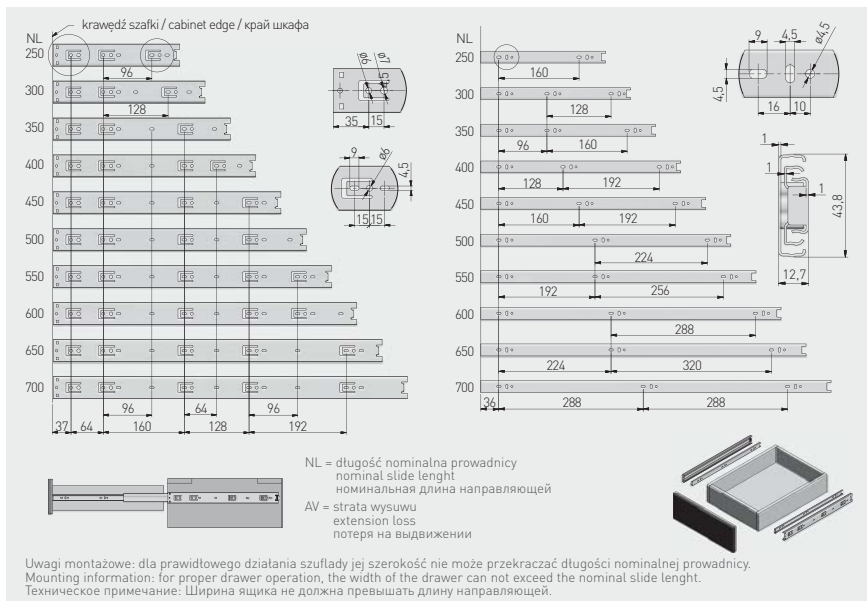

		 L mm	 AV mm		 kg			
PK-0-H45-250		250		pełny full полное	35	ocynk galvanized гальваника	stal steel сталь	15
PK-0-H45-300		300						
PK-0-H45-350		350						
PK-0-H45-400		400						
PK-0-H45-450		450						
PK-0-H45-500		500						
PK-0-H45-550		550						10
PK-0-H45-600		600						
PK-0-H45-700		700						



Prowadnica kulkowa H45 GX1
Ball bearing slide H45 GX1
Шариковая направляющая H45 GX1



		 L mm	 AV mm		 kg		
PK-0H45250GX1		250	5	pełny full полное	30	ocynk galvanized гальваника	stal steel сталь
PK-0H45300GX1		300					
PK-0H45350GX1		350					
PK-0H45400GX1		400					
PK-0H45450GX1		450					
PK-0H45500GX1		500					
PK-0H45550GX1		550					
PK-0H45600GX1		600					
PK-0H45650GX1		650					
PK-0H45700GX1		700					









Prowadnica kulkowa VERSALITE PLUS ze spawalniczem H35
 Ball bearing slide VERSALITE PLUS with soft closing H35
 Шариковая направляющая VERSALITE PLUS с доводчиком H35



krawędź szafki / cabinet edge / край шкафа

NL = długość nominalna prowadnicy / nominal slide length / номинальная длина направляющей
 AV = strata wysuwu / extension loss / потеря на выдвигении

Uwagi montażowe: dla prawidłowego działania szuflady jej szerokość nie może przekraczać długości nominalnej prowadnicy.
 Mounting information: for proper drawer operation, the width of the drawer can not exceed the nominal slide length.
 Техническое примечание: Ширина ящика не должна превышать длину направляющей.

		 L mm	 AV mm		 kg		
PK-L-H35-300		300*	52	petny full полное	20	ocynk galwanizowany гальваника	stal steel сталь
PK-L-H35-350		350*	35				
PK-L-H35-400		400*	20				
PK-L-H35-450		450	4				
PK-L-H35-500		500					
PK-L-H35-550		550					

* Brak pełnego wysuwu / Not full extension / Неполное выдвигение



Prowadnica kulkowa H35
Ball bearing slide H35
Шариковая направляющая H35

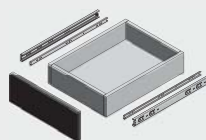
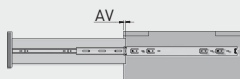
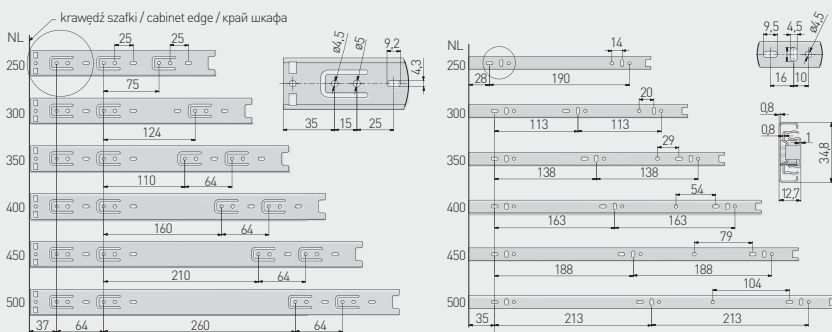

Uwagi montażowe: dla prawidłowego działania szuflady jej szerokość nie może przekraczać długości nominalnej prowadnicy.
Mounting information: for proper drawer operation, the width of the drawer can not exceed the nominal slide length.
Техническое примечание: Ширина ящика не должна превышать длину направляющей.





	L mm	AV mm		kg			
PK-0H35-2500	250	4	pełny full полное	25	ocynk galvanized гальваника	stal steel сталь	30
PK-0-H35-3000	300						20
PK-0-H35-3500	350						20
PK-0-H35-4000	400						20
PK-0-H35-4500	450						20
PK-0-H35-5000	500						20

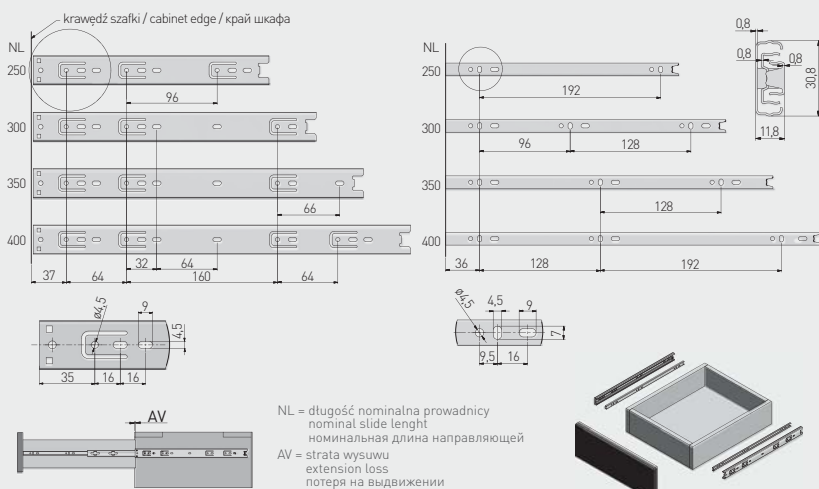

Prowadnica kulkowa H30
Ball bearing slide H30
Шариковая направляющая H30



Uwagi montażowe: dla prawidłowego działania szuflady jej szerokość nie może przekraczać długości nominalnej prowadnicy.
Mounting information: for proper drawer operation, the width of the drawer can not exceed the nominal slide length.
Техническое примечание: Ширина ящика не должна превышать длину направляющей.

	 L mm	 AV mm		 kg		
PK-0H30-2500	250	-	petny full полное	15	ocynk galvanized гальваника	stal steel сталь
PK-0H30-3000	300					
PK-0H30-3500	350					
PK-0H30-4000	400					





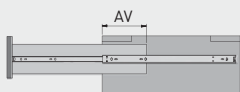
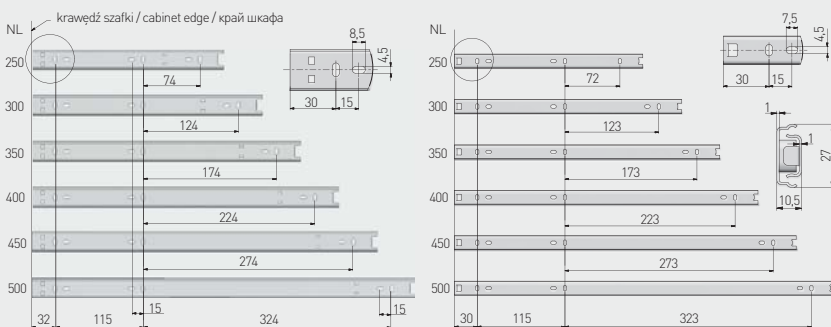

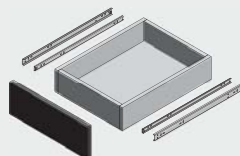

Prowadnica kulkowa H27
 Ball bearing slide H27
 Шариковая направляющая H27



NL = długość nominalna prowadnicy
 nominal slide length
 номинальная длина направляющей
 AV = strata wysuwu
 extension loss
 потеря на выдвигении



Uwagi montażowe: dla prawidłowego działania szuflady jej szerokość nie może przekraczać długości nominalnej prowadnicy.
 Mounting information: for proper drawer operation, the width of the drawer can not exceed the nominal slide length.
 Техническое примечание: Ширина ящика не должна превышать длину направляющей.

	 L mm	 AV mm		 kg		
PK-0H27-3000	300	109	niepełny partial неполное	15	ocynk galvanized гальваника	stal steel сталь
PK-0H27-3500	350	124				
PK-0H27-4000	400	134				
PK-0H27-4500	450	149				
PK-0H27-5000	500	184				



Prowadnica kulkowa do półki pod klawiaturę H27
 Ball bearing slide for keyboard H27
 Шариковая направляющая для полки под клавиатуру H27

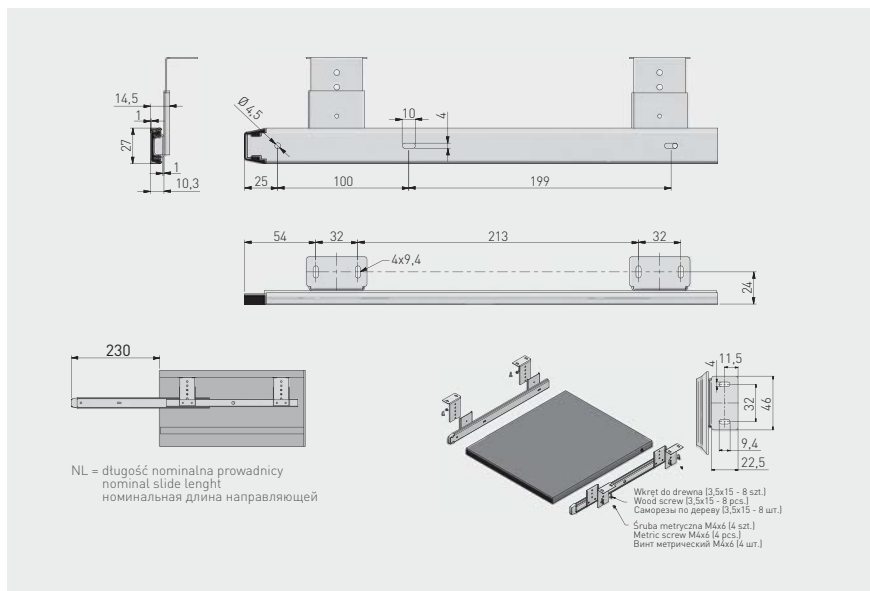

PK-0-000-027	360 mm	niepełny partial неполное	5 kg	ocynk galvanized гальваника	stal steel сталь



Prowadnica kulkowa H17
Ball bearing slide H17
Шариковая направляющая H17

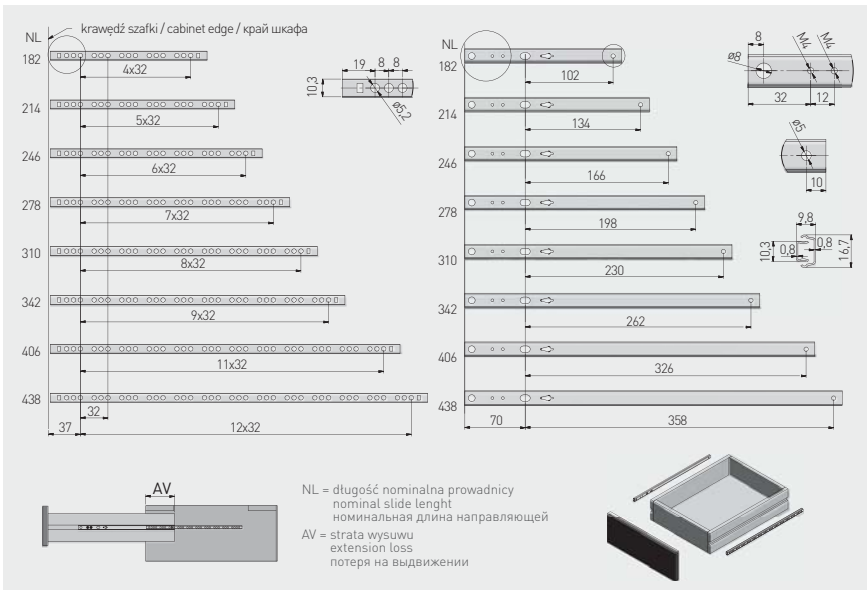

Icon	L (mm)	AV (mm)	Icon	Icon	Icon	Icon	Icon
PK-0H17182XP	182	62	niepełny partial неполное	8	ocynk galvanized гальваника	stal steel сталь	100
PK-0H17214XP	214						
PK-0H17246XP	246						
PK-0H17278XP	278						
PK-0H17310XP	310	100	niepełny partial неполное	8	ocynk galvanized гальваника	stal steel сталь	50
PK-0H17342XP	342						
PK-0H17406XP	406						
PK-0H17438XP	438						



Prowadnica Metalbox MP
 Slide Metalbox MP
 Направляющая Metalbox MP



Wymiary montażowe mocowania frontu:
 Front mounting dimensions:
 Установочные размеры крепления фасада:

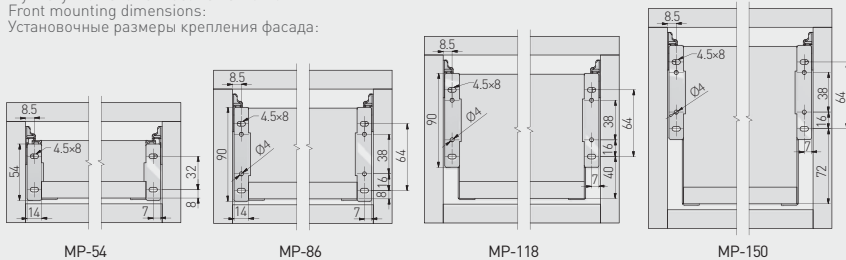

Rozstaw otworów montażowych:
 Mounting dimensions:
 Монтажные отверстия:

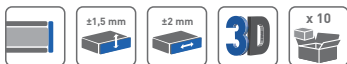
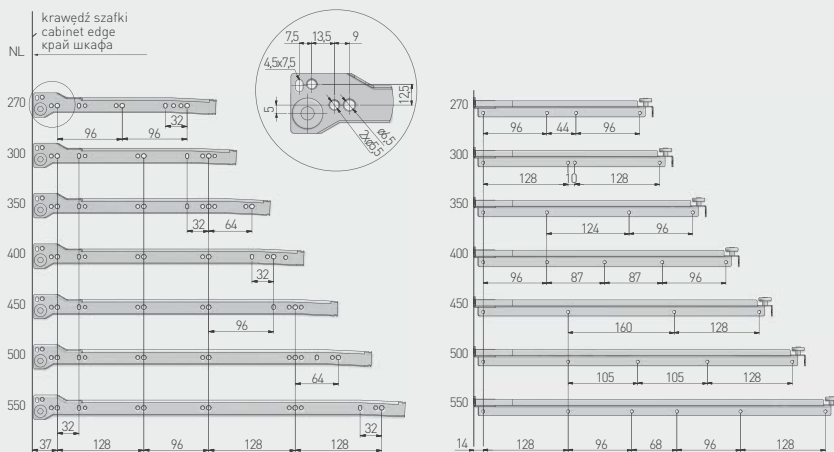

MP-054350-10	54	350	88	niepełny partial неполное	25	lakier lacquer лак	biały white белый	
MP-054400-10		400	98					
MP-054450-10		450						
MP-054500-10		500						
MP-054450-80		450						
MP-054500-80		500						
MP-086270-10	86	270					88	
MP-086300-10		300						
MP-086350-10		350						
MP-086400-10		400	98					
MP-086450-10		450						
MP-086500-10		500						
MP-086550-10		550	118					
MP-086270-80		270	88					
MP-086300-80		300						
MP-086350-80		350						
MP-086400-80		400	98					
MP-086450-80		450						
MP-086500-80		500						
MP-086550-80		550	118					
MP-118350-10		118	350				88	
MP-118400-10			400				98	
MP-118450-10			450					
MP-118500-10			500					
MP-150270-10	150	270	88					
MP-150300-10		300						
MP-150350-10		350						
MP-150400-10		400	98					
MP-150450-10		450						
MP-150500-10		500						
MP-150550-10		550	118					
MP-150270-80		270	88					
MP-150300-80		300						
MP-150350-80		350						
MP-150400-80		400	98					
MP-150450-80		450						
MP-150500-80		500						
MP-150550-80		550	118					

Prowadnica rolkowa SP
Euro roller slide
Роликовая направляющая SP





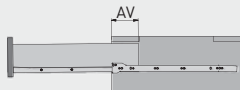
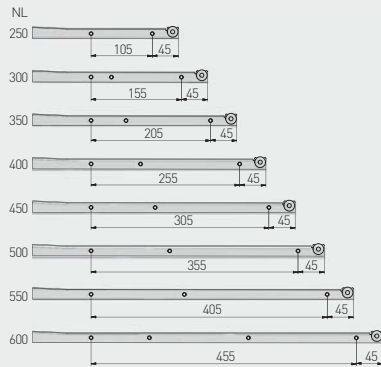
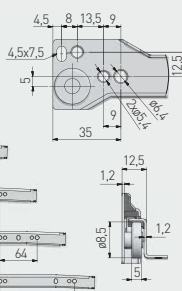
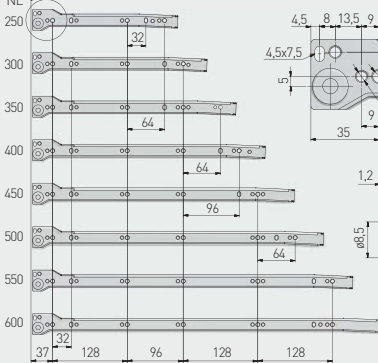

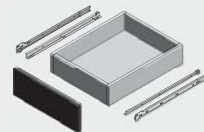

NL krawędź szafki / cabinet edge / край шкафа



NL = długość nominalna prowadnicy
nominal slide length
номинальная длина направляющей
AV = strata wysuwu
extension loss
потеря на выдвигении



		 L mm	 AV mm				
PR-SP-250-10		250	85	25	biały white белый	lakier lacquer лак	stal steel сталь
PR-SP-300-10		300					
PR-SP-350-10		350					
PR-SP-400-10		400					
PR-SP-450-10		450					
PR-SP-500-10		500					
PR-SP-550-10		550	115				
PR-SP-600-10		600					



Prowadnica rolkowa 0B
Euro roller slide 0B
Роликовая направляющая 0B

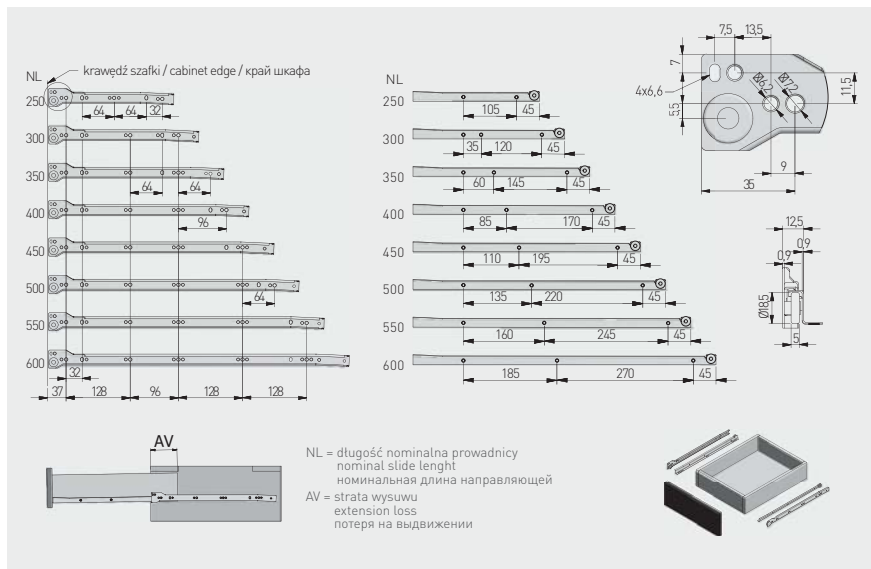



PR-OB-XXXX-10	L (mm)	AV (mm)	kg	Color	Material	PR-OB-XXXX-30	L (mm)	AV (mm)	kg	Color	Material
PR-OB-250-10	250	100	20	biały / white	stal / steel	PR-OB-250-30	250	100	20	brązowy / brown	stal / steel
PR-OB-300-10	300					PR-OB-300-30	300				
PR-OB-350-10	350					PR-OB-350-30	350				
PR-OB-400-10	400					PR-OB-400-30	400				
PR-OB-450-10	450					PR-OB-450-30	450				
PR-OB-500-10	500					PR-OB-500-30	500				
PR-OB-550-10	550					PR-OB-550-30	550				
PR-OB-600-10	600					PR-OB-600-30	600				

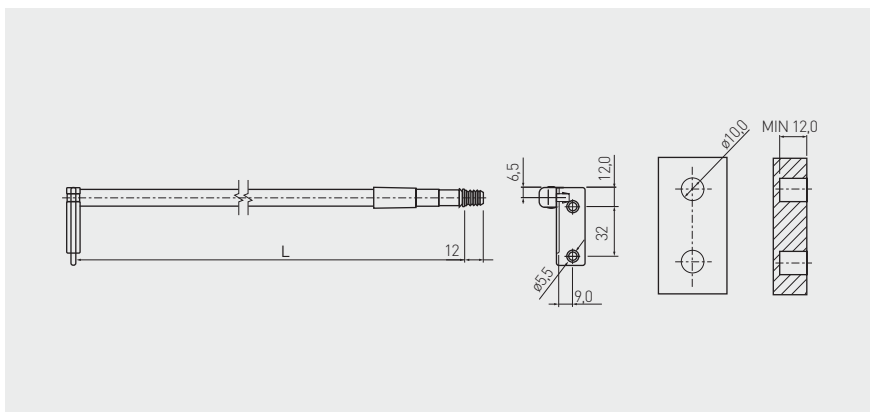

Reling z uchwytem ścianki tylnej lewy / prawy
 Rail with back panel connector left / right
 Релинг с ручкой задней стенки левый / правый



	 L mm	
RS-SZ-400-10	393 / 404	biały / white / белый
RS-SZ-450-10	443 / 454	biały / white / белый
RS-SZ-450-80	443 / 454	srebrny / silver / серебро
RS-SZ-500-10	493 / 504	biały / white / белый
RS-SZ-500-80	493 / 504	srebrny / silver / серебро

L - długość rzeczywista relingu mieszcząca się w przedziale (Lmin; Lmax) / actual length / фактическая длина релинга в пределах (Lмин; Lмакс)



Spowalniacz do prowadnic rolkowych oraz szuflad typu Metalbox 350 - 550 mm
 Soft closing device for euro roller slide and Metalbox 350 - 550 mm
 Доводчик для роликовых направляющих и Металбоксов 350 - 550 мм



AM-MBSOFT-P2	25	szary gray серый	tworzywo plastic пластмасса

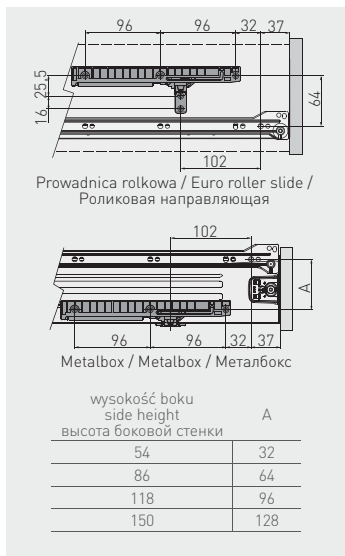

Rolka stabilizująca
 Drawer stabilizer
 Стабилизирующий механизм

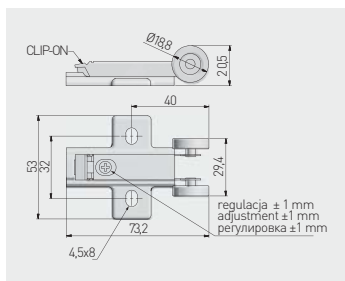

Do szuflad skrzyniowych wyposażonych w prowadnice push to open
 For drawers with push to open
 Для ящиков с направляющими push to open

RB-D-P20STAB	nikiel / nickel / никель	stal / steel / сталь



Modern Box Square

Skład zestawu

Set

Комплектация

MOCOWANIE ŚCIANKI TYLNEJ

niskie / średnie / wysokie
szare / białe

BACK PANEL CONNECTOR

low / medium / high
gray / whiteКРЕПЛЕНИЕ ЗАДНЕЙ СТЕНКИ
низкий / средний / высокий вариант
серый / белый

RELING WZDŁUŻNY

szary / biały
L = 250 - 550 mm

LONGITUDINAL RAIL

gray / white
L = 250 - 550 mm

ПРОДОЛЖНЫЙ РЕЙЛИНГ

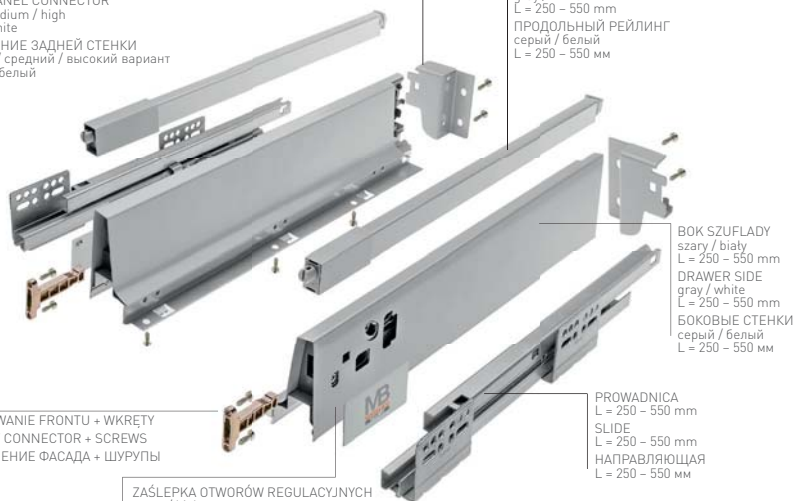
серый / белый
L = 250 - 550 mm

MOCOWANIE FRONTU + WKRETY

FRONT CONNECTOR + SCREWS

КРЕПЛЕНИЕ ФАСАДА + ШРУПЫ

BOK SZUFLADY

szary / biały
L = 250 - 550 mm

DRAWER SIDE

gray / white
L = 250 - 550 mm

БОКОВЫЕ СТЕНКИ

серый / белый
L = 250 - 550 mm

PROWADNICA

L = 250 - 550 mm

SLIDE

L = 250 - 550 mm

НАПРАВЛЯЮЩАЯ

L = 250 - 550 mm

ZAŚLEPKA OTWORÓW REGULACYJNYCH

szara / biała

COVER CAP

gray / white

ЗАГЛУШКИ ДЛЯ ОТВЕРСТИЙ

серый / белый



Modern Box Square

Komplet szuflady niskiej A
Low drawer set A
Низкий ящик A

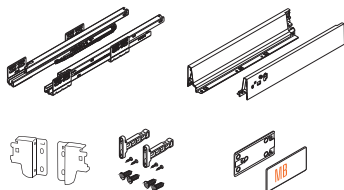

PB-KW-KPL300A	300	40	szary gray серый	lakier lacquer лак	stal steel сталь	
PB-KW-KPL350A	350					
PB-KW-KPL400A	400					
PB-KW-KPL450A	450					
PB-KW-KPL500A	500					
PB-KW-KPL550A	550		biały white белый			
PB-KW-KPL250A1	250					
PB-KW-KPL300A1	300					
PB-KW-KPL350A1	350					
PB-KW-KPL400A1	400					
PB-KW-KPL450A1	450		antracyt anthracite антрацитовый			
PB-KW-KPL500A1	500					
PB-KW-KPL550A1	550					
PB-KW-KPL250A2	250					
PB-KW-KPL300A2	300					
PB-KW-KPL350A2	350					
PB-KW-KPL400A2	400					
PB-KW-KPL450A2	450					
PB-KW-KPL500A2	500					
PB-KW-KPL550A2	550					

Modern Box Square

Komplet szuflady średniej B
Medium drawer set B
Средний ящик B

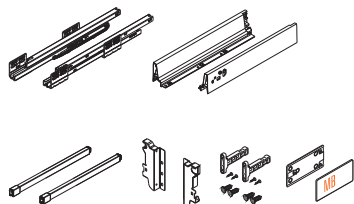

PB-KW-KPL250B	250	40	szary gray серый	lakier lacquer лак	stal steel сталь	
PB-KW-KPL350B	350					
PB-KW-KPL400B	400					
PB-KW-KPL450B	450					
PB-KW-KPL500B	500					
PB-KW-KPL550B	550		biały white белый			
PB-KW-KPL250B1	250					
PB-KW-KPL300B1	300					
PB-KW-KPL350B1	350					
PB-KW-KPL400B1	400					
PB-KW-KPL450B1	450		antracyt anthracite антрацитовый			
PB-KW-KPL500B1	500					
PB-KW-KPL550B1	550					
PB-KW-KPL250B2	250					
PB-KW-KPL300B2	300					
PB-KW-KPL350B2	350					
PB-KW-KPL400B2	400					
PB-KW-KPL450B2	450					
PB-KW-KPL500B2	500					
PB-KW-KPL550B2	550					

Modern Box Square

Komplet szuflady wysokiej C
High drawer set C
Высокий ящик C

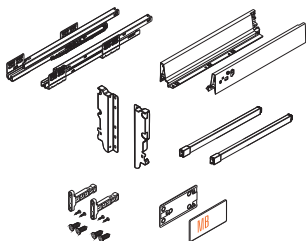

PB-KW-KPL250C	250	40	szary gray серый	lakier lacquer лак	stal steel сталь
PB-KW-KPL300C	300				
PB-KW-KPL350C	350				
PB-KW-KPL400C	400				
PB-KW-KPL450C	450				
PB-KW-KPL500C	500	40	biały white белый	lakier lacquer лак	stal steel сталь
PB-KW-KPL550C	550				
PB-KW-KPL250C1	250				
PB-KW-KPL300C1	300				
PB-KW-KPL350C1	350				
PB-KW-KPL400C1	400	40	antracyt anthracite антрацитовый	lakier lacquer лак	stal steel сталь
PB-KW-KPL450C1	450				
PB-KW-KPL500C1	500				
PB-KW-KPL550C1	550				
PB-KW-KPL250C2	250				
PB-KW-KPL300C2	300	40	antracyt anthracite антрацитовый	lakier lacquer лак	stal steel сталь
PB-KW-KPL350C2	350				
PB-KW-KPL400C2	400				
PB-KW-KPL450C2	450				
PB-KW-KPL500C2	500				
PB-KW-KPL550C2	550	40	antracyt anthracite антрацитовый	lakier lacquer лак	stal steel сталь
PB-KW-KPL250C2	250				
PB-KW-KPL300C2	300				
PB-KW-KPL350C2	350				
PB-KW-KPL400C2	400				
PB-KW-KPL450C2	450	40	antracyt anthracite антрацитовый	lakier lacquer лак	stal steel сталь
PB-KW-KPL500C2	500				
PB-KW-KPL550C2	550				
PB-KW-KPL250C2	250				
PB-KW-KPL300C2	300				



Reiling wzdłużny Longitudinal drawer rail Продольный рейлинг

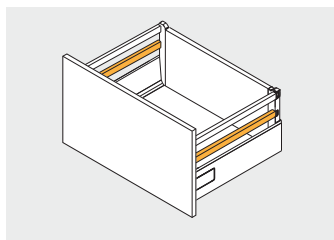

PB-D-RELKW350	350	szary gray серый	lakier lacquer лак	stal steel сталь
PB-D-RELKW400	400			
PB-D-RELKW450	450			
PB-D-RELKW500	500			
PB-D-RELKW550	550			



PB-D-RELKW350-10	350	biały white белый	lakier lacquer лак	stal steel сталь
PB-D-RELKW400-10	400			
PB-D-RELKW450-10	450			
PB-D-RELKW500-10	500			
PB-D-RELKW550-10	550			



Złączka frontu wewnętrzznego, niska
 Inner front connector, low
 Соединитель передней панели, низкий

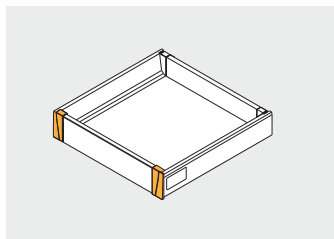

PB-D-WEWMOCA-KW	szuflada niska A low drawer A низкий ящик A	szary / gray / серый	tworzywo plastic пластмасса
PB-D-WEWMOCA-KW-10		biały / white / белый	



Złączka frontu wewnętrzznego, średnia
 Inner front connector, medium
 Соединитель передней панели, средний

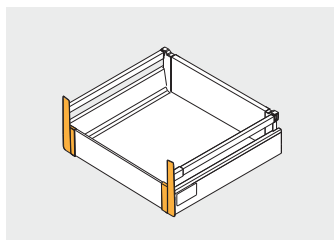

PB-D-WEWMOCB-KW	szuflada średnia B medium drawer B средний ящик B	szary / gray / серый	tworzywo plastic пластмасса
PB-D-WEWMOCB-KW-10		biały / white / белый	



Złączka frontu wewnętrznego, wysoka
 Inner front connector, high
 Соединитель передней панели, высокий

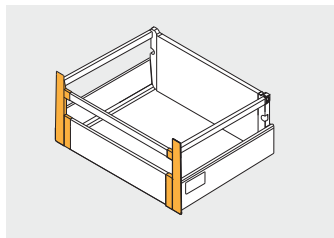

PB-D-WEWMOCC-KW	szuflada wysoka C high drawer C высокий ящик C	szary / gray / серый	tworzywo plastic пластмасса
PB-D-WEWMOCC-KW-10		biały / white / белый	



Panel przedni frontu wewnętrznego
 Front panel
 Передняя панель внутреннего ящика

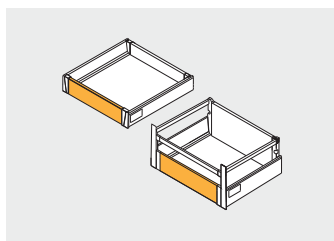

PB-D-PANELWEW	1100	szary / gray / серый	aluminium aluminium алюминий
PB-D-PANELWEW-10		biały / white / белый	



Reling poprzeczny
Transverse rail
Поперечный рейлинг

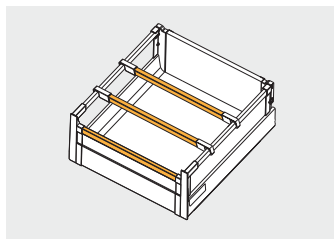





	 L mm		
PB-RP-KW1100	1100	szary / gray / серый	stal steel сталь
PB-RP-KW1100-10		biały / white / белый	

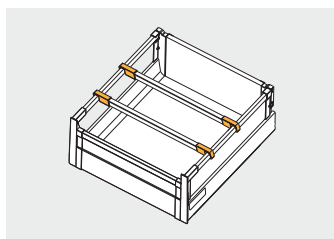

Łącznik relingu poprzecznego
Transverse rail connector
Соединитель поперечного рейлинга



			
PB-D-ZR-KW-00	1 kpl. = 2 szt. 1 set = 2 pcs 1 комп. = 2 шт.	szary / gray / серый	tworzywo plastic пластмасса
PB-D-ZR-KW-10		biały / white / белый	



Listwa poprzeczna
Transverse bar
Поперечная планка

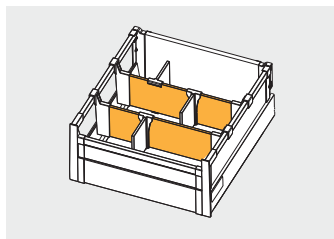





			
PB-D-LIS1100-KW	1100	szary / gray / серый	aluminium aluminium алюминий
PB-D-LIS1100-KW-10		biały / white / белый	

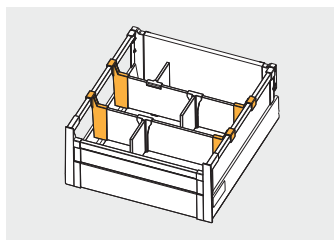

Złączka do listwy poprzecznej
Transverse bar connector
Соединитель поперечной планки



			
PB-D-CONREL-KW	1 kpl. = 2 szt. 1 set = 2 pcs 1 комп. = 2 шт.	szary / gray / серый	tworzywo plastic пластмасса
PB-D-CONREL-KW-10		biały / white / белый	



Przegroda do listwy poprzecznej
 Transverse bar divider
 Перегородка для поперечной планки

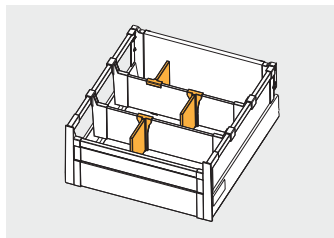

PB-D-PRZEGLP-KW	1 szt.	szary / gray / серый	tworzywo plastic пластмасса
PB-D-PRZEGLP-KW-10	1 pc 1 шт.	biały / white / белый	



Mocowanie relingu do podwyższonej ścianki tylnej
 Back panel connector for rails, additional
 Соединитель задней стенки для рейлингов, дополнительная

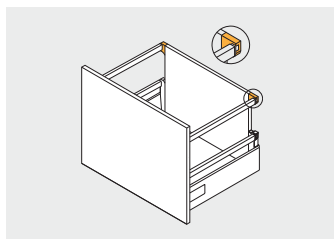

PB-D-D2R0-00	1 kpl. = 2 szt.	szary / gray / серый	tworzywo plastic пластмасса
PB-D-D2R0-01	1 set = 2 pcs 1 комп. = 2 шт.	biały / white / белый	



Złączka ścianki tylnej, niska
 Back panel connector, low
 Держатель задней стенки, низкий

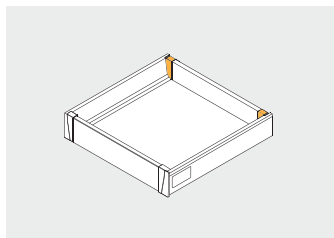

PB-D-N2R0-00	1 kpl. = L+P 1 set = L+R	szary / gray / серый	stal steel
PB-D-N2R0-01	1 комп. = Л+П	biały / white / белый	сталь



Złączka ścianki tylnej, średnia
 Back panel connector, medium
 Держатель задней стенки, средний

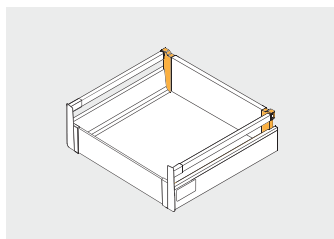

PB-D-S2R0-00	1 kpl. = L+P 1 set = L+R	szary / gray / серый	stal steel
PB-D-S2R0-01	1 комп. = Л+П	biały / white / белый	сталь



Złączka ścianki tylnej, wysoka
 Back panel connector, high
 Держатель задней стенки, высокий

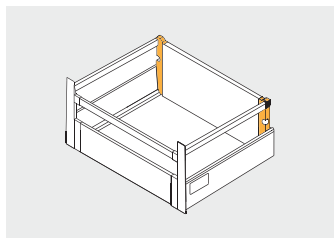

PB-D-W2R0-00	1 kpL. = L+P 1 set = L+R	szary / gray / серый	stal steel
PB-D-W2R0-01	1 комп. = Л+П	biały / white / белый	stal сталь



Mocowanie do relingów
 Rails mounting
 Держатель рейлинга



PB-D-MHG04-KW	1 szt. 1 pc 1 шт.	szary gray серый	tworzywo plastic пластмасса
---------------	-------------------------	------------------------	-----------------------------------



Matryca do relingów
 Marking gauge for rails
 Матрица для рейлингов



			
PB-D-MATRYCA	1 kpl. = 1 szt. 1 set = 1 pc 1 комп. = 1 шт.	szary gray серый	tworzywo plastic пластмасса



Znacznik do frontów
 Marking gauge for drawer front
 Маркер фасада



			
PB-D-ZNACZ-0	1 kpl. = 2 szt. 1 set = 2 pcs 1 комп. = 2 шт.	szary gray серый	ZnAl



Modern Box

Skład zestawu
Set
Комплектация

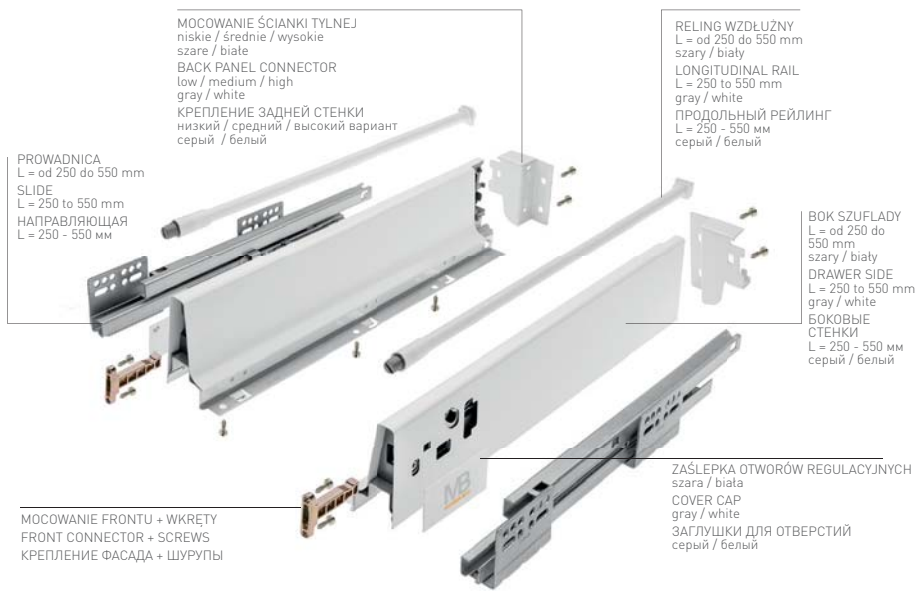

Modern Box

Komplet szuflady niskiej A
Low drawer set A
Низкий ящик А

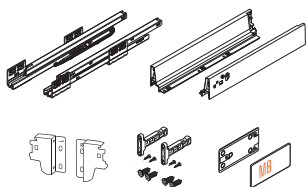

PB-D-KPL250A	250	soft close	40	szary gray серый	lakier lacquer лак	stal steel сталь
PB-D-KPL300A	300					
PB-D-KPL350A	350					
PB-D-KPL400A	400					
PB-D-KPL450A	450					
PB-D-KPL500A	500					
PB-D-KPL550A	550					
PB-D-KPL250A1	250	push to open		szary gray серый		
PB-D-KPL300A1	300					
PB-D-KPL350A1	350					
PB-D-KPL400A1	400					
PB-D-KPL450A1	450					
PB-D-KPL500A1	500					
PB-D-KPL550A1	550					
PB-D-P20250A	250	push to open	szary gray серый			
PB-D-P20300A	300					
PB-D-P20350A	350					
PB-D-P20400A	400					
PB-D-P20450A	450					
PB-D-P20500A	500					
PB-D-P20550A	550					



Modern Box

Komplet szuflady średniej B
Medium drawer set B
Средний ящик B

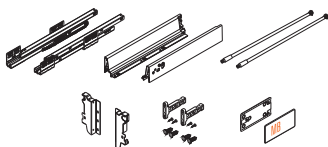

PB-D-KPL300B	300	soft close	40	szary gray серый	lakier lacquer лак	stal steel сталь
PB-D-KPL350B	350					
PB-D-KPL400B	400					
PB-D-KPL450B	450					
PB-D-KPL500B	500					
PB-D-KPL550B	550					

Modern Box



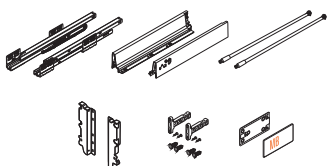



Komplet szuflady wysokiej C
High drawer set C
Высокий ящик C

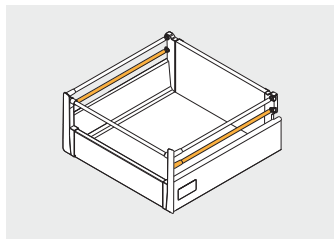





PB-D-KPL250C	250	soft close	40	szary gray серый	lakier lacquer лак	stal steel сталь
PB-D-KPL300C	300					
PB-D-KPL350C	350					
PB-D-KPL400C	400					
PB-D-KPL450C	450					
PB-D-KPL500C	500					
PB-D-KPL550C	550			szary gray серый		
PB-D-KPL250C1	250					
PB-D-KPL300C1	300					
PB-D-KPL350C1	350					
PB-D-KPL400C1	400					
PB-D-KPL450C1	450	push to open	szary gray серый			
PB-D-KPL500C1	500					
PB-D-KPL550C1	550					
PB-D-P20250C	250					
PB-D-P20300C	300					
PB-D-P20350C	350					
PB-D-P20400C	400					
PB-D-P20450C	450					
PB-D-P20500C	500					
PB-D-P20550C	550					

Reling wzdużny
Longitudinal rail
Продольный рейлинг







	 L mm		
PB-D-REL2500	250		
PB-D-REL3000	300		
PB-D-REL3500	350		
PB-D-REL4000	400		
PB-D-REL4500	450		
PB-D-REL5000	500		
PB-D-REL5500	550	szary gray серый	stal steel сталь

	 L mm		
PB-D-REL450-10	450	biały white белый	stal steel сталь
PB-D-REL500-10	500		
PB-D-REL550-10	550		

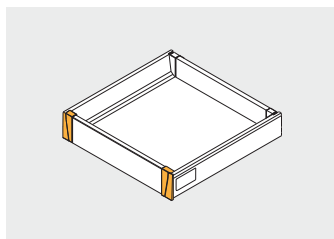

Złączka frontu wewnętrzznego, niska
Inner front connector, low
Соединитель передней панели, низкий



			
PB-D-WEWMOCA	szuflada niska A low drawer A низкий ящик A	szary / gray / серый	tworzywo plastic пластмасса
PB-D-WEWMOCA1			



Złączka frontu wewnętrzznego, średnia
 Inner drawer connector, medium
 Соединитель передней панели, средний

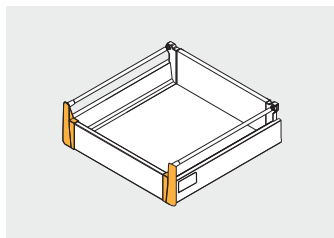

PB-D-WEWMOCB	szuflada średnia B medium drawer B средний ящик B	szary / gray / серый	tworzywo plastic пластмасса
PB-D-WEWMOCB1		biały / white / белый	



Złączka frontu wewnętrzznego, wysoka, do 1 kompletu relingów
 Inner drawer connector high, for 1 set of rails
 Соединитель передней панели, высокий, для 1 комплекта рейлингов

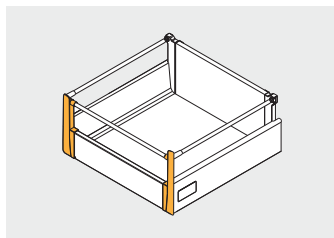





PB-D-WEWSZKLC	szuflada wysoka C, 1 reling high drawer C, 1 rail высокий ящик C, рейлинг - 1 шт.	szary / gray / серый	tworzywo plastic пластмасса
PB-D-WEWSZKLC-10		biały / white / белый	

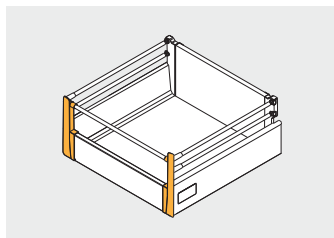

Złączka frontu wewnętrznej, wysoka, do 2 kompletów relingów
 Inner drawer front connector, high, for 2 sets of rails
 Соединитель передней панели, высокий, для 2 комплектов рельингов







			
PB-D-WEWMOCC	szuflada wysoka C, 2 relingi high drawer C, 2 rails высокий ящик C, рейлинг -2 шт.	szary / gray / серый	tworzywo plastic пластмасса
PB-D-WEWMOCC1		biały / white / белый	

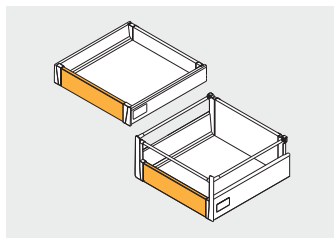

Panel przedni frontu wewnętrznej
 Front panel
 Передняя панель







	 mm		
PB-D-PANELWEW	1100	szary / gray / серый	aluminium aluminium алюминий
PB-D-PANELWEW-10		biały / white / белый	

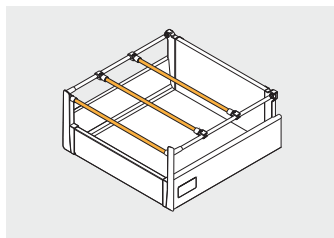

Reling poprzeczny
Transverse rail
Поперечный рейлинг



			
PB-D-RP-1100	1100 mm	szary / gray / серый	stal steel сталь
PB-D-RP-1100-10		biały / white / белый	



Łącznik relingu poprzecznego
Transverse rail connector
Соединитель поперечного рейлинга

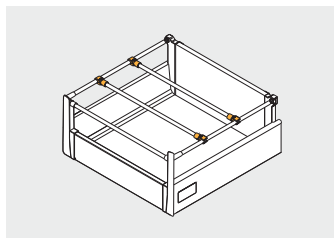

			
PB-D-ZR-00-0	1 kpl. = 2 szt. 1 set = 2 pcs 1 комп. = 2 шт.	szary / gray / серый	tworzywo plastic пластмасса
PB-D-ZR-00-10		biały / white / белый	



Uchwyt do szuflady wewnętrznej
Inner drawer handle
Ручка для внутреннего ящика

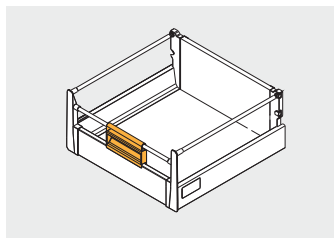

PB-D-UCHWEW	szary / gray / серый	tworzywo plastic пластмасса
PB-D-UCHWEW-10	biały / white / белый	



Łącznik krzyżowy do relingu
Cross rail connector
Крестообразный соединитель рейлингов

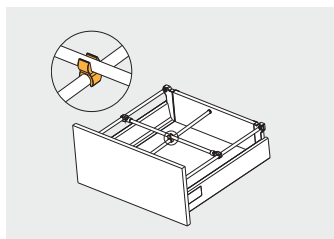

PB-D-LR-00-0	szary / gray / серый	tworzywo plastic пластмасса
PB-D-LR-00-10	biały / white / белый	



Zaślepka do relingu poprzecznego
End cap for transverse rail
Заглушка для поперечного рейлинга

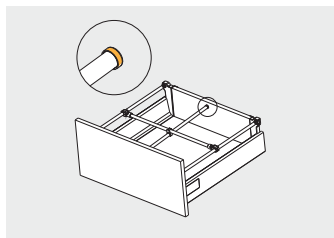





		
PB-D-RELCOV	szary / gray / серый	tworzywo plastic пластмасса
PB-D-RELCOV-10	biały / white / белый	

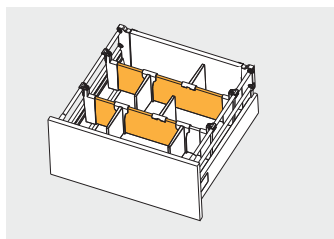

Listwa poprzeczna
Transverse bar
Поперечная планка



			
PB-D-LIS1100	1100	szary / gray / серый	aluminium aluminium алюминий
PB-D-LIS1100-10		biały / white / белый	



Złączka listwy poprzecznej do relingu
 Connector for transverse rail and bar
 Соединитель поперечных планок и рейлингов

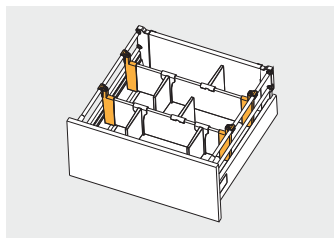

PB-D-CONREL	1 kpl. = 2 szt. 1 set = 2 pcs	szary / gray / серый	tworzywo plastic пластмасса
PB-D-CONREL-10	1 комп. = 2 шт.	biały / white / белый	



Złączka listwy poprzecznej do boku perforowanego
 Transverse bar connector for perforated sides
 Соединитель поперечных планок и перфорированных боковин

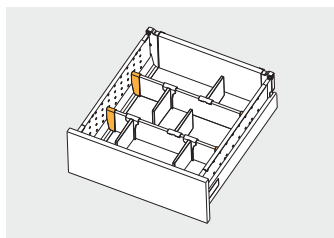

PB-D-CONBXSID	1 kpl. = 2 szt. 1 set = 2 pcs	szary / gray / серый	tworzywo plastic пластмасса
PB-D-CONBXSIDE-10	1 комп. = 2 шт.	biały / white / белый	



Przegroda listwy poprzecznej
 Transverse bar divider
 Перегородка для поперечной планки

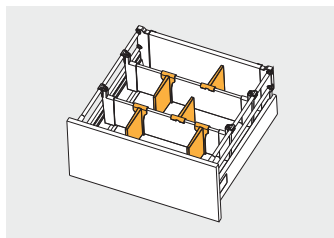

PB-D-PRZEGLP	szary / gray / серый	tworzywo plastic пластмасса
PB-D-PRZEGLP-10	biały / white / белый	



Bok perforowany do szuflady średniej
 Perforated side for medium drawer
 Перфорированная боковина, низкая

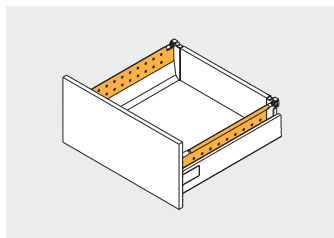





PB-D-BXSIDE45B	450	szary / gray / серый	stal steel сталь
PB-D-BXSIDE45B-10		biały / white / белый	
PB-D-BXSIDE50B	500	szary / gray / серый	
PB-D-BXSIDE50B-10		biały / white / белый	

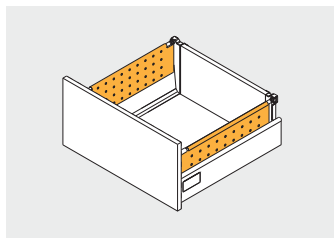
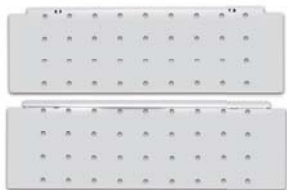

Bok perforowany do szuflady wysokiej
 Perforated side for high drawer
 Перфорированная боковина, высокая







	 L mm		
PB-D-BXSIDE45C	450	szary / gray / серый	stal steel сталь
PB-D-BXSIDE45C-10		biały / white / белый	
PB-D-BXSIDE50C	500	szary / gray / серый	
PB-D-BXSIDE50C-10		biały / white / белый	

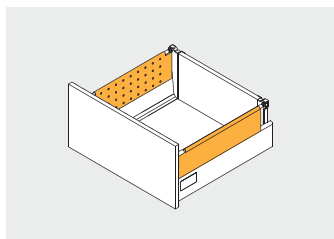
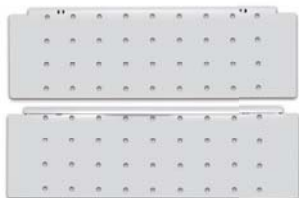

Podwójny bok perforowany do szuflady wysokiej
 Double perforated side for high drawer
 Боковая стенка для высокого ящика, двойная, перфорированная







	 L mm		
PB-D-DBOX450C	450	szary gray серый	stal steel сталь
PB-D-DBOX500C	500		

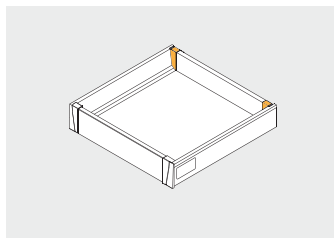

Złączka ścianki tylnej, niska
 Back panel connector, low
 Соединитель задней стенки, низкий







			
PB-D-N2R0-00	1 kpl. = L+P 1 set = L+R	szary / gray / серый	stal steel
PB-D-N2R0-01	1 комп. = Л+П	biały / white / белый	сталь

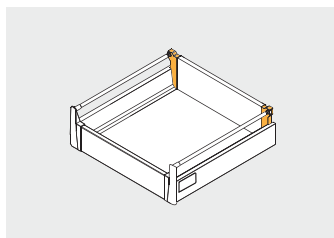

Złączka ścianki tylnej, średnia
 Back panel connector, medium
 Соединитель задней стенки, средний







			
PB-D-S2R0-00	1 kpl. = L+P 1 set = L+R	szary / gray / серый	stal steel
PB-D-S2R0-01	1 комп. = Л+П	biały / white / белый	сталь

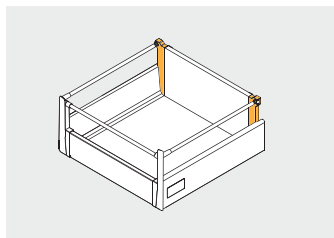

Złączka ścianki tylnej, wysoka
 Back panel connector, high
 Соединитель задней стенки, высокий



			
PB-D-W2R0-00	1 kpl. = L+P 1 set = L+R	szary / gray / серый	stal steel
PB-D-W2R0-01	1 комп. = Л+П	biały / white / белый	сталь



Mocowanie relingu do podwyższonej ścianki tylnej
 Back panel connector for rails, additional
 Соединитель задней стенки для рейлингов, дополнительная

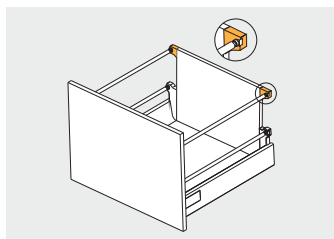

			
PB-D-D2R0-00	1 kpl. = 2 szt. 1 set = 2 pcs	szary / gray / серый	tworzywo plastic
PB-D-D2R0-01	1 комп. = 2 шт.	biały / white / белый	пластмасса



Matryca do relingów
 Marking gauge for rails
 Матрица для рейлингов



PB-D-MATRYCA	1 kpl. = 1 szt. 1 set = 1 pcs 1 комп. = 1 шт.	szary gray серый	tworzywo plastic пластмасса
--------------	---	------------------------	-----------------------------------



Znacznik do frontów
 Marking gauge for drawer front
 Маркер фасада



PB-D-ZNACZ-0	1 kpl. = 2 szt. 1 set = 2 pcs 1 комп. = 2 шт.	szary gray серый	ZnAl
--------------	---	------------------------	------



Mocowanie do relingów
 Rail mounting
 Держатель рейлинга







PB-D-MHG04	1 kpl. = 2 szt. 1 set = 2 pcs 1 комп. = 2 шт.	szary gray серый	tworzywo plastic пластмасса
------------	---	------------------------	-----------------------------------

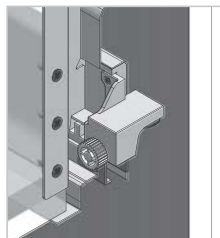

Rolka stabilizująca do szuflad push to open
 Drawer stabilizer for push to open drawers
 Стабилизирующий механизм для ящиков









			
PB-D-MBSTAB-00	1 kpl. = L+P 1 set = L+R 1 комп. = Л+П	szary gray серый	tworzywo plastic пластмасса



Modern Box

Komplet szuflady piekarnikowej niskiej
 Under oven drawer set – low
 Ящик под духовку, низкий



					
PB-D-KPL68-450-80	450	40	szary gray серый	lakier lacquer лак	stal steel сталь
PB-D-KPL68-500-80	500		biały white белый		
PB-D-KPL68-450-10	450				
PB-D-KPL68-500-10	500				

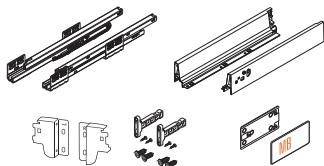

Modern Box

Komplet szuflady narożnej niskiej
Corner drawer set – low
Угловой ящик, низкий



PB-D-COR600A	600	40	szary gray серый	lakier lacquer лак	stal steel сталь
PB-D-COR650A	650				

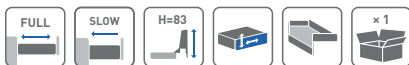
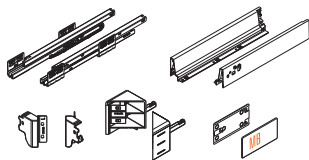

Modern Box

Komplet szuflady narożnej wysokiej
Corner drawer set – high
Угловой ящик, высокий



PB-D-COR600C	600	40	szary gray серый	lakier lacquer лак	stal steel сталь
PB-D-COR650C	650				

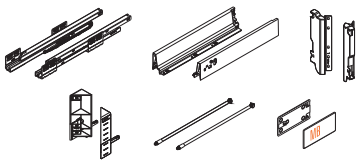

Modern Box

Komplet szuflady zlewozmywakowej niskiej
Under sink drawer – set
Ящик под мойку



PB-D-ZLE-450	450	40	szary gray серый	lakier lacquer лак	stal steel сталь
PB-D-ZLE-500	500				

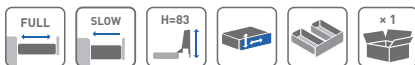
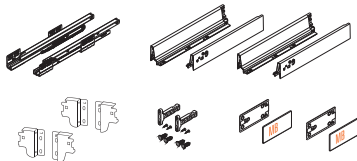

Modern Box

Komplet szuflady zlewozmywakowej U, niskiej
Under sink drawer U, low – set
Ящик под мойку U, низкий – компоненты



PB-D-ULE-500	500	40	szary gray серый	lakier lacquer лак	stal steel сталь
--------------	-----	----	------------------------	--------------------------	------------------------

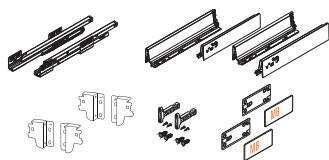

AXIS

Skład zestawu
Set
Комплектация

БОК SZUFLADY
szary / biały
L = 300 – 550 mm

DRAWER SIDE
gray / white
L = 300 – 550 mm

БОКОВИНЫ
цвет: серый / белый
L = 300 – 550 мм

MOCOWANIE ŚCIANKI
TYLNEJ
niskie / średnie / wysokie
szare / białe

BACK PANEL CONNECTOR
low / medium / high
gray / white

КРЕПЛЕНИЕ ЗАДНЕЙ
СТЕНКИ
низкое / среднее / высокое
серый / белый

ultracienki płaszcz boczny
ultra thin drawer sides
ультратонкие боковины



MOCOWANIE FRONTU
+ WKRETY

FRONT CONNECTOR
+ SCREWS

КРЕПЛЕНИЕ ФАСАДА
+ ШУРУПЫ

ZASŁEPKA OTWORÓW
REGULACYJNYCH
szara / biała

COVER CAP
gray / white

ЗАГЛУШКИ ДЛЯ ОТВЕРСТИЙ
серый / белый

PROWADNICA
L = 270 – 550 mm

SLIDE
L = 270 – 550 mm

НАПРАВЛЯЮЩАЯ
L = 270 – 550 мм



AXIS

Komplet szuflady niskiej A
Low drawer set A
Низкий ящик A

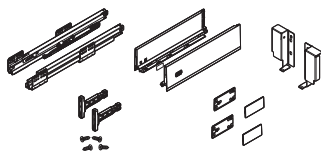

PB-AXIS-KPL300A	300	40	szary gray серый	lakier lacquer лак	stal steel сталь
PB-AXIS-KPL350A	350				
PB-AXIS-KPL400A	400				
PB-AXIS-KPL450A	450				
PB-AXIS-KPL500A	500				
PB-AXIS-KPL550A	550		biały white белый		
PB-AXIS-KPL300A1	300				
PB-AXIS-KPL350A1	350				
PB-AXIS-KPL400A1	400				
PB-AXIS-KPL450A1	450				
PB-AXIS-KPL500A1	500				
PB-AXIS-KPL550A1	550				

AXIS

Komplet szuflady średniej B
Medium drawer set B
Средний ящик B

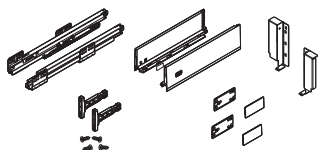





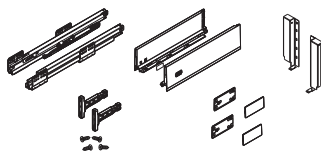

PB-AXIS-KPL300B	300	40	szary gray серый	lakier lacquer лак	stal steel сталь
PB-AXIS-KPL350B	350				
PB-AXIS-KPL400B	400				
PB-AXIS-KPL450B	450				
PB-AXIS-KPL500B	500				
PB-AXIS-KPL550B	550		biały white белый		
PB-AXIS-KPL300B1	300				
PB-AXIS-KPL350B1	350				
PB-AXIS-KPL400B1	400				
PB-AXIS-KPL450B1	450				
PB-AXIS-KPL500B1	500				
PB-AXIS-KPL550B1	550				

AXIS

Komplet szuflady wysokiej C
 High drawer set C
 Высокий ящик C



		 mm	 kg			
PB-AXIS-KPL300C		300				
PB-AXIS-KPL350C		350				
PB-AXIS-KPL400C		400				
PB-AXIS-KPL450C		450				
PB-AXIS-KPL500C		500				
PB-AXIS-KPL550C		550				
PB-AXIS-KPL300C1		300				
PB-AXIS-KPL350C1		350				
PB-AXIS-KPL400C1		400				
PB-AXIS-KPL450C1		450				
PB-AXIS-KPL500C1		500				
PB-AXIS-KPL550C1		550				

Mocowanie relingu do podwyższonej ścianki tylnej

Back panel connector for rails, additional

Соединитель задней стенки для рейлингов, дополнительная

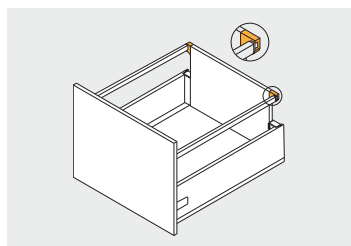

			
PB-AXIS-U2R0-00	1 kpl. = 2 szt. 1 set = 2 pcs	szary / gray / серый	tworzywo plastic
PB-AXIS-U2R0-10	1 комп. = 2 шт.	biały / white / белый	пластмасса



Reiling wzdużny
Longitudinal rail
Продольный рейлинг

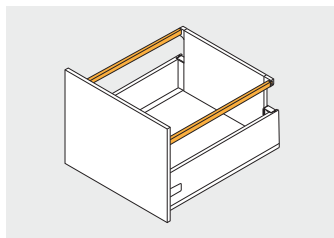





				
PB-AXIS-RELKW300	300	szary / gray / серый	lakier lacquer лак	stal steel сталь
PB-AXIS-RELKW300-10		biały / white / белый		
PB-AXIS-RELKW350	350	szary / gray / серый		
PB-AXIS-RELKW350-10		biały / white / белый		
PB-AXIS-RELKW400	400	szary / gray / серый		
PB-AXIS-RELKW400-10		biały / white / белый		
PB-AXIS-RELKW450	450	szary / gray / серый		
PB-AXIS-RELKW450-10		biały / white / белый		
PB-AXIS-RELKW500	500	szary / gray / серый		
PB-AXIS-RELKW500-10		biały / white / белый		
PB-AXIS-RELKW550	550	szary / gray / серый		
PB-AXIS-RELKW550-10		biały / white / белый		

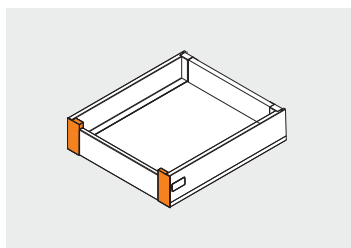

Złączka frontu wewnętrznej, niska
Inner front connector low
Соединитель передней панели, низкий



			
PB-AXIS-WEWMOCA	szuflada niska A low drawer A низкий ящик A	szary / gray / серый	tworzywo plastic пластмасса
PB-AXIS-WEWMOCA1		biały / white / белый	



Złączka frontu wewnętrznej, średnia
 Inner front connector medium
 Соединитель передней панели, средний

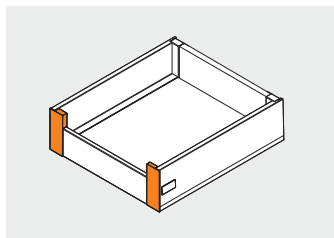

PB-AXIS-WEWMOCB	szuflada średnia B medium drawer B средний ящик B	szary / gray / серый	tworzywo plastic пластмасса
PB-AXIS-WEWMOCB1		biały / white / белый	



Złączka frontu wewnętrznej, wysoka
 Inner front connector high
 Соединитель передней панели, высокий

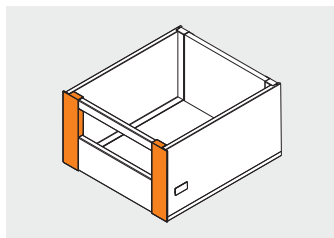

PB-AXIS-WEWMOCC	szuflada wysoka C high drawer C высокий ящик C	szary / gray / серый	tworzywo plastic пластмасса
PB-AXIS-WEWMOCC1		biały / white / белый	



Panel przedni frontu wewnętrznego
Front panel
Передняя панель

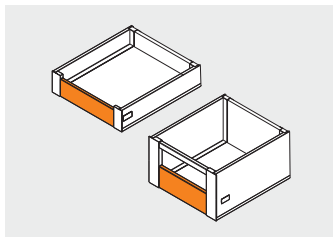





	 L mm		
PB-AXIS-PANELWEW	1054	szary / gray / серый	aluminium
PB-AXIS-PANELWEW-10		biały / white / белый	aluminium алюминий

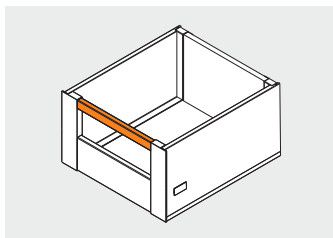

Reling poprzeczny
Transverse rail
Поперечный рейлинг



	 L mm		
PB-AXIS-RP-1100	1100	szary / gray / серый	stal
PB-AXIS-RP-1100-10		biały / white / белый	steel сталь



LINOS BOX



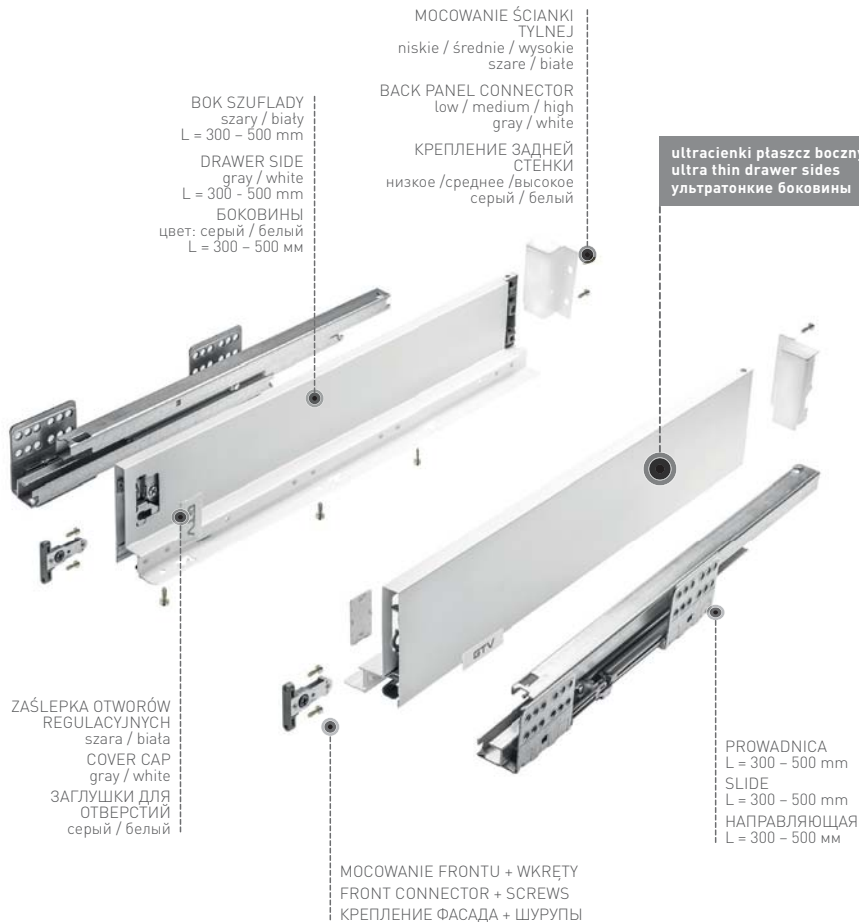



Skład zestawu
Set
Комплектация



LINOS BOX

Komplet szuflady niskiej A
Low drawer set A
Низкий ящик A









	 L mm	 kg			
PB-LINOS-KPL300A	300	40	szary gray серый	lakier lacquer лак	stal steel сталь
PB-LINOS-KPL350A	350				
PB-LINOS-KPL400A	400				
PB-LINOS-KPL450A	450				
PB-LINOS-KPL500A	500				
PB-LINOS-KPL300A1	300		biały white белый		
PB-LINOS-KPL350A1	350				
PB-LINOS-KPL400A1	400				
PB-LINOS-KPL450A1	450				
PB-LINOS-KPL500A1	500				



LINOS BOX

Komplet szuflady średniej B
Medium drawer set B
Средний ящик B







	 L mm	 kg			
PB-LINOS-KPL350B	350	40	szary gray серый	lakier lacquer лак	stal steel сталь
PB-LINOS-KPL400B	400				
PB-LINOS-KPL450B	450				
PB-LINOS-KPL500B	500				
PB-LINOS-KPL350B1	350				
PB-LINOS-KPL400B1	400				
PB-LINOS-KPL450B1	450				
PB-LINOS-KPL500B1	500				



LINOS BOX

Komplet szuflady wysokiej C
High drawer set C
Высокий ящик C







					
PB-LINOS-KPL350C	350	40	szary gray серый	lakier lacquer лак	stal steel сталь
PB-LINOS-KPL400C	400				
PB-LINOS-KPL450C	450				
PB-LINOS-KPL500C	500				
PB-LINOS-KPL350C1	350		biały white белый		
PB-LINOS-KPL400C1	400				
PB-LINOS-KPL450C1	450				
PB-LINOS-KPL500C1	500				



LINOS BOX

Komplet szuflady bardzo wysokiej D
Very high drawer set D
Очень высокий ящик D







					
PB-LINOS-KPL450D	450	40	szary gray серый	lakier lacquer лак	stal steel сталь
PB-LINOS-KPL500D	500				
PB-LINOS-KPL450D1	450		biały white белый		
PB-LINOS-KPL500D1	500				

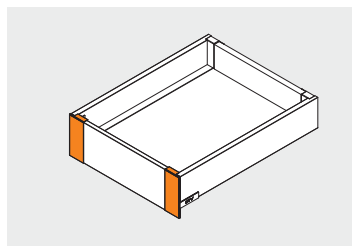

Złączka frontu wewnętrznej, niska
 Inner front connector low
 Соединитель передней панели, низкий



			
PB-LINOS-WEWMOCA1	szuflada niska A low drawer A низкий ящик A	biały / white / белый	stal, tworzywo steel, plastic сталь, пластмасса
PB-LINOS-WEWMOCA		szary / gray / серый	



Złączka frontu wewnętrznej, wysoka
 Inner front connector high
 Соединитель передней панели, высокий

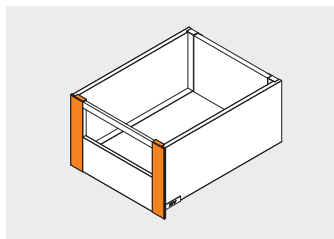





			
PB-LINOS-WEWMOCD1	szuflada wysoka D high drawer D высокий ящик D	biały / white / белый	stal, tworzywo steel, plastic сталь, пластмасса
PB-LINOS-WEWMOCD		szary / gray / серый	
PB-LINOS-WEWMOCC1	szuflada wysoka C high drawer C высокий ящик C	biały / white / белый	
PB-LINOS-WEWMOCC		szary / gray / серый	

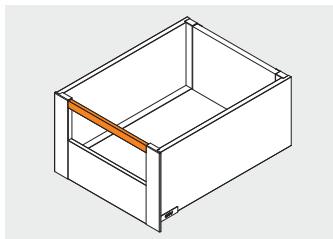

Reling poprzeczny
Transverse rail
Поперечный рейлинг







	 L mm		
PB-LINOS-RP-1200-10	1200	biały / white / белый	stal steel сталь
PB-LINOS-RP-1200		szary / gray / серый	

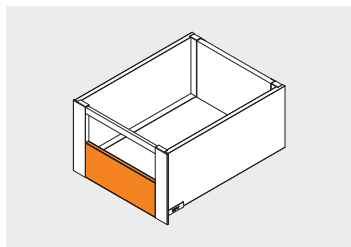

Panel przedni frontu wewnętrzznego
Front panel
Передняя панель



	 L mm		
PB-LINOS-PANELWEW-10	1200	biały / white / белый	stal steel сталь
PB-LINOS-PANELWEW		szary / gray / серый	



Podpórka PELIKAN mini Shelf support PELIKAN mini Полкодержатель PELIKAN мини

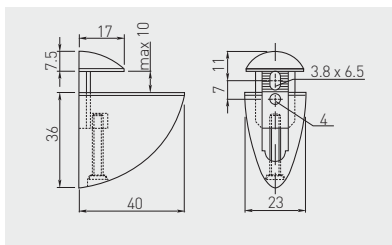

PP-XS0045-01	chrom / chrome / хром	ZnAl
PP-XS0045-05	aluminium / aluminium / алюминий	

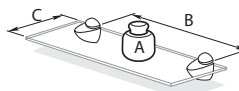

A - max 5 kg / макс. 5 кг
B - 25 cm / 25 см
C - 15 cm / 15 см

Maksymalne obciążenie zależy od ilości wsporników i materiału z jakiego wykonana jest półka.

The maximum load depends on the number of supports and material of which the self is made.

Максимальная нагрузка зависит от количества кронштейнов и материала, из которого изготовлена полка.

Podpórka PELIKAN mała Shelf support PELIKAN small Полкодержатель PELIKAN маленький

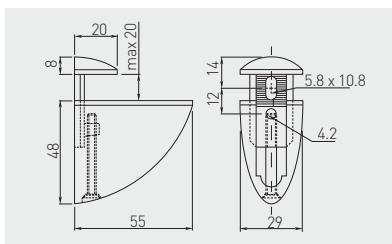

PP-MP0055-01	chrom / chrome / хром	ZnAl
PP-MP0055-02	satyna / satin / сатин	
PP-MP0055-05	aluminium / aluminium / алюминий	
PP-MP0055-06	stal szorstkowana / brushed steel / шлифованная сталь	
PP-MP0055-10	biały / white / белый	
PP-MP0055-20	czarny / black / чёрный	

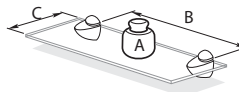

A - max 8 kg / макс. 8 кг
B - 40 cm / 40 см
C - 20 cm / 20 см

Maksymalne obciążenie zależy od ilości wsporników i materiału z jakiego wykonana jest półka.

The maximum load depends on the number of supports and material of which the self is made.

Максимальная нагрузка зависит от количества кронштейнов и материала, из которого изготовлена полка.

Podrórka PELIKAN średnia Shelf support PELIKAN medium Полкодержатель PELIKAN средний

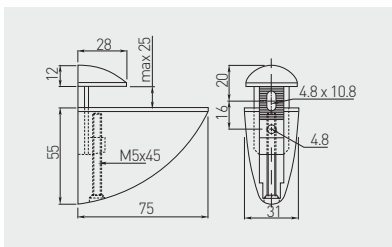

PP-SP0075-01	chrom / chrome / хром	ZnAl
PP-SP0075-02	satyna / satin / сатин	
PP-SP0075-05	aluminium / aluminium / алюминий	
PP-SP0075-06	stal szcztokowana / brushed steel шлифованная сталь	

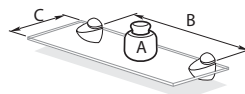

A - max 10 kg / макс. 10 кг
B - 50 cm / 50 см
C - 25 cm / 25 см

Maksymalne obciążenie zależy od ilości wsporników i materiału z jakiego wykonana jest półka.

The maximum load depends on the number of supports and material of which the self is made.

Максимальная нагрузка зависит от количества кронштейнов и материала, из которого изготовлена полка.

Podrórka PELIKAN duża Shelf support PELIKAN large Полкодержатель PELIKAN большой

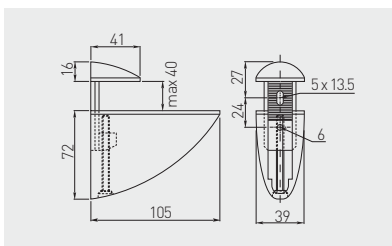

PP-DP0105-01	chrom / chrome / хром	ZnAl
PP-DP0105-02	satyna / satin / сатин	
PP-DP0105-05	aluminium / aluminium / алюминий	
PP-DP0105-06	stal szcztokowana / brushed steel шлифованная сталь	

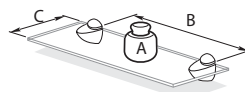

A - max 12 kg / макс. 12 кг
B - 60 cm / 60 см
C - 30 cm / 30 см

Maksymalne obciążenie zależy od ilości wsporników i materiału z jakiego wykonana jest półka.

The maximum load depends on the number of supports and material of which the self is made.

Максимальная нагрузка зависит от количества кронштейнов и материала, из которого изготовлена полка.

Podpórka GS01 Shelf support GS01 Полкодержатель GS01

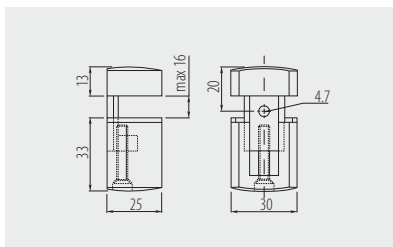

PP-00GS01-01	chrom / chrome / хром	ZnAl
PP-00GS01-02	satyna / satin / сатин	
PP-00GS01-05	aluminium / aluminium / алюминий	

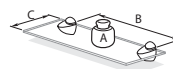

A - max 3 kg / макс. 3 кг
B - 25 cm / см
C - 15 cm / см

Maksymalne obciążenie zależy od ilości wsporników i materiału z jakiego wykonana jest półka.

The maximum load depends on the number of supports and material of which the shelf is made.

Максимальная нагрузка зависит от количества кронштейнов и материала, из которого изготовлена полка.

Podpórka GS02 Shelf support GS02 Полкодержатель GS02

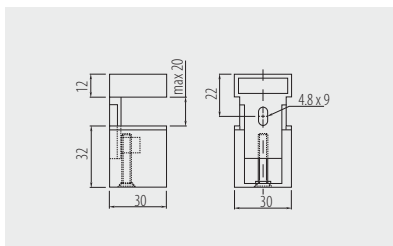

PP-00GS02-01	chrom / chrome / хром	ZnAl
PP-00GS02-02	satyna / satin / сатин	
PP-00GS02-05	aluminium / aluminium / алюминий	
PP-00GS02-06	stal szorstkowana / brushed steel / шлифованная сталь	

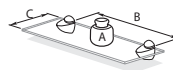

A - max 4 kg / макс. 4 кг
B - 40 cm / см
C - 20 cm / см

Maksymalne obciążenie zależy od ilości wsporników i materiału z jakiego wykonana jest półka.

The maximum load depends on the number of supports and material of which the shelf is made.

Максимальная нагрузка зависит от количества кронштейнов и материала, из которого изготовлена полка.

Podpórka GS03 Shelf support GS03 Полкодержатель GS03

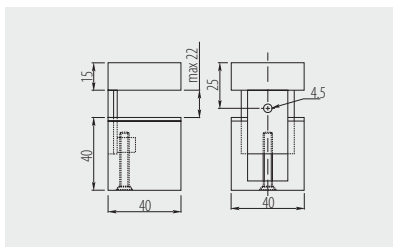

PP-00GS03-01	chrom / chrome / хром	ZnAl
PP-00GS03-02	satyna / satin / сатин	
PP-00GS03-05	aluminium / aluminium / алюминий	
PP-00GS03-06	stal szorstkowana / brushed steel / шлифованная сталь	

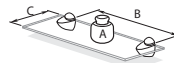

A - max 6 kg / макс. 6 кг
B - 50 cm / см
C - 25 cm / см

Maksymalne obciążenie zależy od ilości wsporników i materiału z jakiego wykonana jest półka.

The maximum load depends on the number of supports and material of which the self is made.

Максимальная нагрузка зависит от количества кронштейнов и материала, из которого изготовлена полка.

Podpórka GS04 Shelf support GS04 Полкодержатель GS04

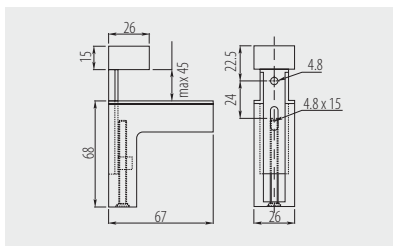

PP-00GS04-01	chrom / chrome / хром	ZnAl
PP-00GS04-02	satyna / satin / сатин	
PP-00GS04-05	aluminium / aluminium / алюминий	
PP-00GS04-06	stal szorstkowana / brushed steel / шлифованная сталь	

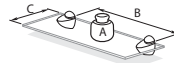

A - max 10 kg / макс. 10 кг
B - 60 cm / см
C - 30 cm / см

Maksymalne obciążenie zależy od ilości wsporników i materiału z jakiego wykonana jest półka.

The maximum load depends on the number of supports and material of which the self is made.

Максимальная нагрузка зависит от количества кронштейнов и материала, из которого изготовлена полка.

Podpórka A48 mocowana na wkręt
Shelf support A48 screw mounted
Полкодержатель A48 монтаж на винт

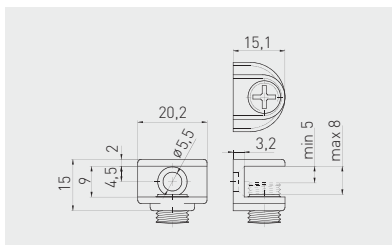

		
PP-GL-A48-01	chrom / chrome / хром	ZnAl



Podpórka B48 mocowana na wcisk
Shelf support B48 plug in
Полкодержатель B48 вставной

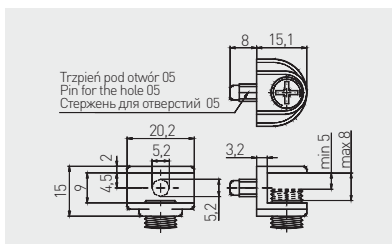

		
PP-GL-B48-01	chrom / chrome / хром	ZnAl



Podpórka CGP mocowana na wkręt
Shelf support CGP screw mounted
Полкодержатель CGP монтаж на винт

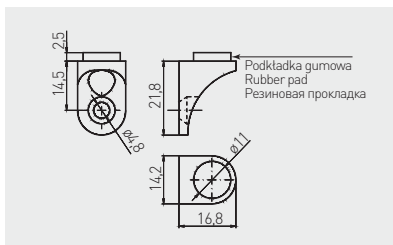

		
PP-GL-CGP-01	chrom / chrome / хром	ZnAl



Podpórka E410 mocowana na wcisk
Shelf support E410 plug in
Полкодержатель E410 вставной

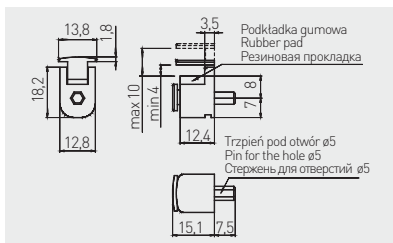

		
PP-GL-E410-01	chrom / chrome / хром	ZnAl



Podrórka F46 mocowana na wcisk
Shelf support F46 plug in
Полкодержатель F46 вставной

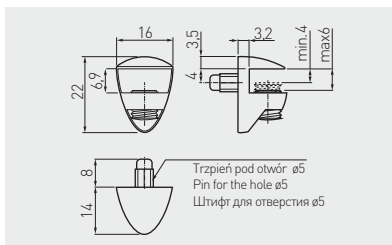

PP-GL-F46B-01



chrom / chrome / хром



ZnAl



GLASS



x 1000

Podrórka SL3
Shelf support SL3
Полкодержатель SL3

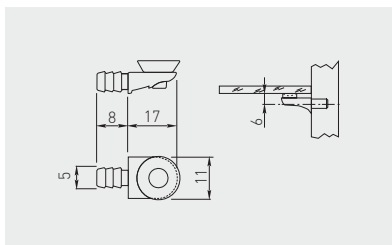

PP-S0L003-01



chrom / chrome / хром



ZnAl, tworzywo / ZnAl, plastic / ZnAl, пластмасса



GLASS



x 2000

Podpórka SL12
Shelf support SL12
Полкодержатель SL12

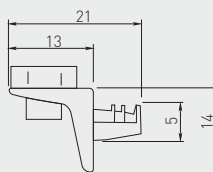

Grubość szkła max 5 mm
Glass thickness, max. 5 mm
Толщина стекла макс. 5 мм



PP-S0L012-01



chrom / chrome / хром



ZnAl, tworzywo / ZnAl, plastic / ZnAl, пластмасса



Podpórka HS0
Shelf support HS0
Полкодержатель HS0

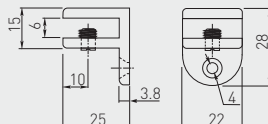

Grubość szkła max 5 mm
Glass thickness, max. 5 mm
Толщина стекла макс. 5 мм



PP-HS0006-01



chrom / chrome / хром



ZnAl



Podpórka HS2
Shelf support HS2
Полкодержатель HS2

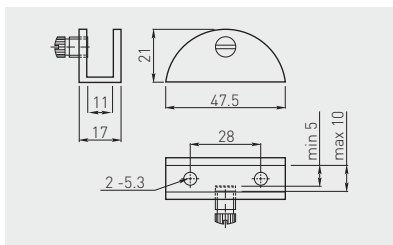

PP-HS2710-01	chrom / chrome / хром	ZnAl



Podpórka J63
Shelf support J63
Полкодержатель J63

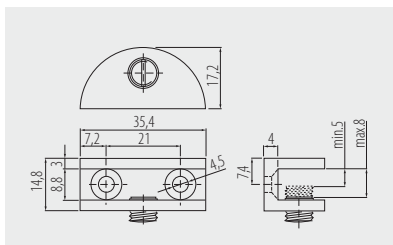







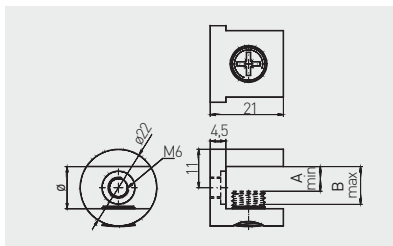

MC-J63-01	chrom / chrome / хром	ZnAl
MC-J63-06	stal szorstkowana / brushed steel / шлифованная сталь	



Podpórka J65 Shelf support J65 Полкодержатель J65



	 mm	 mm	 mm			
MC-J65-08-01	8	4	8	chrom / chrome / хром		
MC-J65-08-05	8	4	8	stal szcztokowana / brushed steel / шлифованная сталь		
MC-J65-10-01	10	6	10	chrom / chrome / хром		
MC-J65-10-05	10	6	10	stal szcztokowana / brushed steel / шлифованная сталь		
MC-J65-12-01	12	7	11	chrom / chrome / хром		
MC-J65-12-05	12	7	11	stal szcztokowana / brushed steel / шлифованная сталь		



Podpórka J123 Shelf support J123 Полкодержатель J123

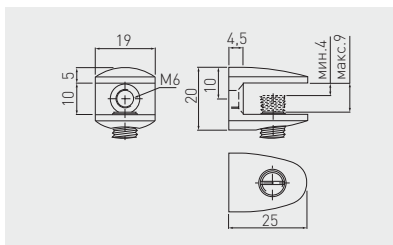

		
MC-J123-01	chrom / chrome / хром	ZnAl
MC-J123-05	stal szcztokowana / brushed steel / шлифованная сталь	



Podpórka K135 Shelf support K135 Полкодержатель K135

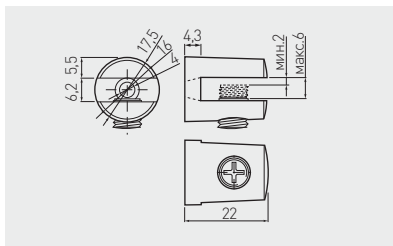

MC-K135-06-01	chrom / chrome / хром	ZnAl



Mocowanie J01 Fixture J01 Крепление J01

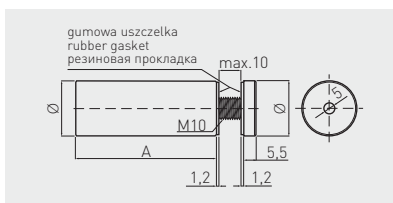

MC-J01A-12-01	12	16,5	chrom / chrome / хром		stal steel сталь	160		
MC-J01A-12-06			stal szcztokowana / brushed steel / шлифованная сталь					
MC-J01A-16-01	16	25	chrom / chrome / хром			stal steel сталь	60	
MC-J01A-16-06			stal szcztokowana / brushed steel / шлифованная сталь					
MC-J01A-19-01	19	35	chrom / chrome / хром				stal steel сталь	40
MC-J01A-19-06			stal szcztokowana / brushed steel / шлифованная сталь					
MC-J01A-25-01	25	64	chrom / chrome / хром					stal steel сталь
MC-J01A-25-06			stal szcztokowana / brushed steel / шлифованная сталь					



Mocowanie J02
 Fixture J02
 Крепление J02

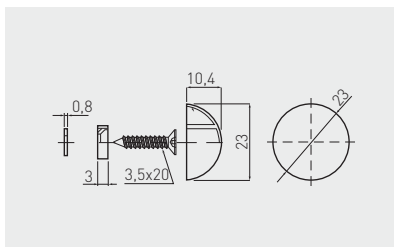

MC-J02A-25-01	23	chrom / chrome / хром	stal / steel / сталь



Mocowanie J04
 Fixture J04
 Крепление J04

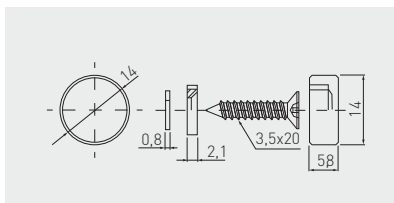

MC-J04A2-14-01	14	chrom / chrome / хром	ZnAl	300
MC-J04A2-14-06	14	stal szczotkowana / brushed steel / шлифованная сталь		
MC-J04A2-18-01	18	chrom / chrome / хром		200
MC-J04A2-22-01	22	chrom / chrome / хром		100
MC-J04A2-22-06	22	stal szczotkowana / brushed steel / шлифованная сталь		



Mocowanie J60
Fixture J60
Крепление J60

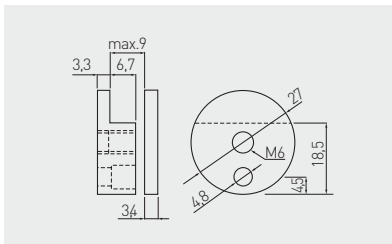

		
MC-J60A27-01	chrom / chrome / хром	ZnAl
MC-J60A27-06	stal szcztokowana / brushed steel / шлифованная сталь	



Mocowanie J62
Fixture J62
Крепление J62

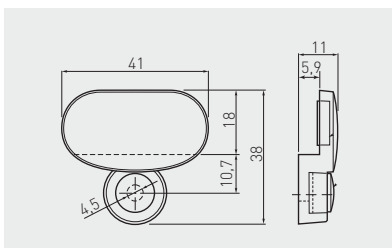

		
MC-J62-06	stal szcztokowana / brushed steel / шлифованная сталь	ZnAl



Mocowanie K90
 Fixture K90
 Крепление K90

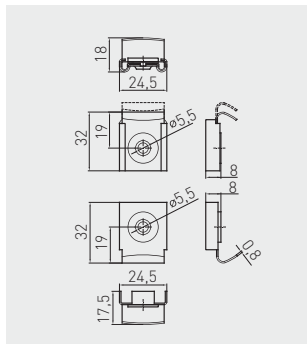

MC-K090-AR-01



chrom / chrome / хром



stal / steel / сталь



Mocowanie K91
 Fixture K91
 Крепление K91

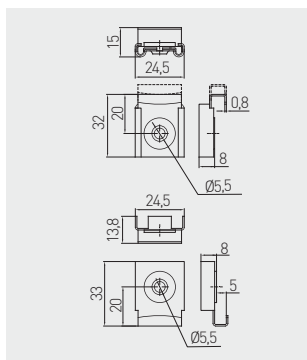

MC-K091-SQ-01



chrom / chrome / хром



stal / steel / сталь



Podpórka GL
Shelf support GL
Полкодержатель GL

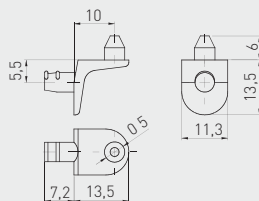

		
PP-GL-DR5-01	chrom / chrome / хром	ZnAl
PP-GL-DR5-15	nikiel / nickel / никель	



Podpórka DR6
Shelf support DR6
Полкодержатель DR6

NEW

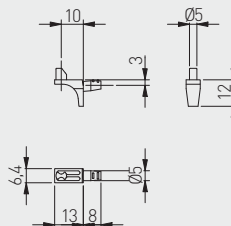

		
PP-GL-DR6-01	chrom / chrome / хром	ZnAl
PP-GL-DR6-15	nikiel / nickel / никель	



Podpórka SAFETY
Shelf support SAFETY
Полкодержатель SAFETY

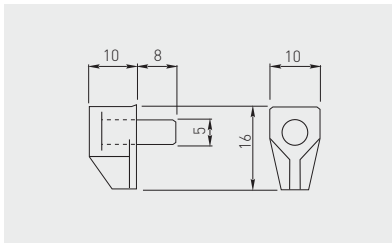

PP-SPL001-01	przeźroczysty transparent прозрачный	stal, tworzywo steel, plastic сталь, пластмасса



Podpórka MR-11
Shelf support pin MR-11
Полкодержатель MR-11

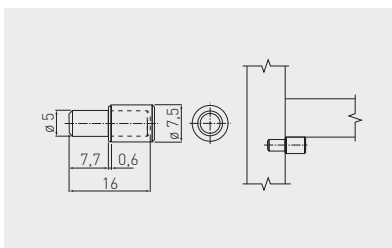

MR-ZSL011-01	z nakładką with plastic coating с накладкой	chrom / chrome / хром	stal / steel / сталь
MR-TDL011-01	bez nakładki without plastic coating без накладки		



Podpórka SMART
Shelf support SMART
Полкодержатель SMART

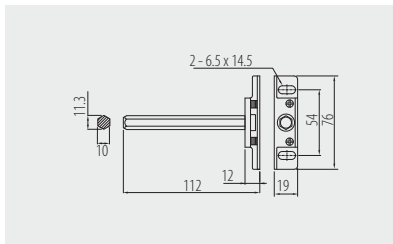

PP-SMART-000	srebrny / silver / серебристый	stal / steel / сталь



Podpórka CLEAR
Shelf support CLEAR
Полкодержатель CLEAR

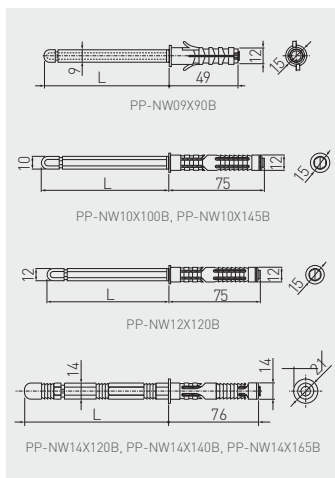

	mm	mm	kg				
PP-NW09X90B	9	90	10	brąz brown коричневый	stal steel сталь	200	
PP-NW10X100B	10	110	15				
PP-NW10X145B	10	145	15				
PP-NW12X120B	12	120	15				
PP-NW14X120B	14	120	25				
PP-NW14X140B	14	140	25				
PP-NW14X165B	14	165	25	100			



Podrórka LUK pod półkę
Shelf support bracket LUK
Полкодержатель LUK

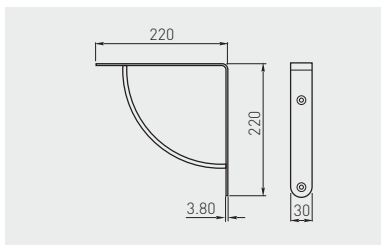

PP-LUK-00-01	30 / 2 szt. 30 / 2 pcs. 30 / 2 шт.	chrom / chrome / хром	stal steel сталь
PP-LUK-00-02		satyna / satin / сатин	
PP-LUK-00-05		aluminium / aluminium / алюминий	



Podrórka WB-24 pod półkę
Shelf support bracket WB-24
Полкодержатель WB-24

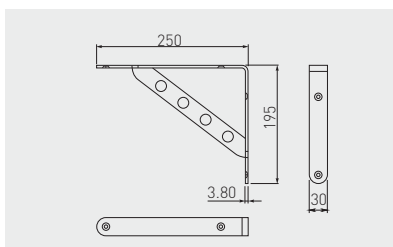

WB-073024-01	30 / 2 szt. 30 / 2 pcs. 30 / 2 шт.	chrom / chrome / хром	stal / steel / сталь
WB-073024-06		stal szcztokowana / brushed steel / шлифованная сталь	



Podrórka WB-25 pod półkę
Shelf support bracket WB-25
Полкодержатель WB-25

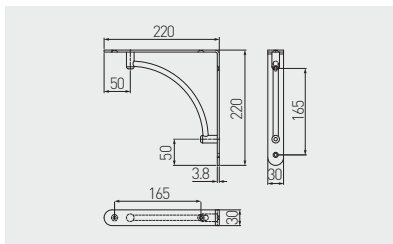

WB-073025-01	30 / 2 szt. 30 / 2 pcs.	chrom / chrome / хром	stal / steel / сталь
WB-073025-06	30 / 2 шт.	stal szcztokowana / brushed steel / шлифованная сталь	



Podrórka WB-26 pod półkę
Shelf support bracket WB-26
Полкодержатель WB-26

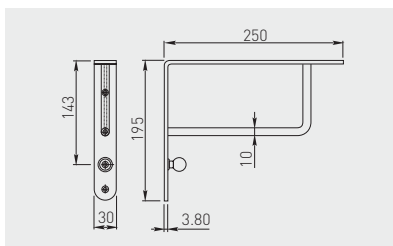

WB-073026-01	30 / 2 szt. 30 / 2 pcs.	chrom / chrome / хром	stal / steel / сталь
WB-073026-06	30 / 2 шт.	stal szcztokowana / brushed steel / шлифованная сталь	



Podrórka WS12

Shelf support bracket WS12

Полкодержатель WS12

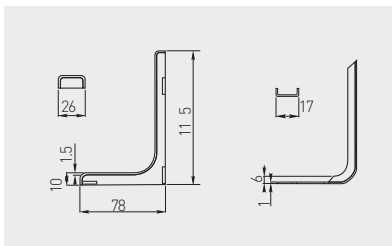

WB-WS-12-001	120	8 / 2 szt. 8 / 2 pcs. 8 / 2 шт.	chrom / chrome / хром	tworzywo plastic пластмасса
WB-WS-12-010			biały / white / белый	
WB-WS-12-020			czarny / black / чёрный	
WB-WS-12-030			brąz / brown / коричневый	
WB-WS-12-031			ciemny brąz / dark brown / темно-коричневый	
WB-WS-12-032			jasny brąz / light brown / светло-коричневый	
WB-WS-12-033			kalwados / calvados / кальвадос	
WB-WS-12-060			szary / gray / серый	



Podrórka WS18

Shelf support bracket WS18

Полкодержатель WS18

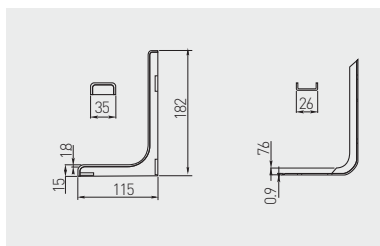

WB-WS-18-001	180	9,5 / 2 szt. 9,5 / 2 pcs. 9,5 / 2 шт.	chrom / chrome / хром	tworzywo plastic пластмасса
WB-WS-18-010	180		biały / white / белый	
WB-WS-18-020	180		czarny / black / чёрный	
WB-WS-18-030	180		brąz / brown / коричневый	
WB-WS-18-031	180		ciemny brąz / dark brown / темно-коричневый	
WB-WS-18-032	180		jasny brąz / light brown / светло-коричневый	
WB-WS-18-033	180		kalwados / calvados / кальвадос	
WB-WS-18-060	180		szary / gray / серый	



Podpórka WS24
Shelf support bracket WS24
Полкодержатель WS24

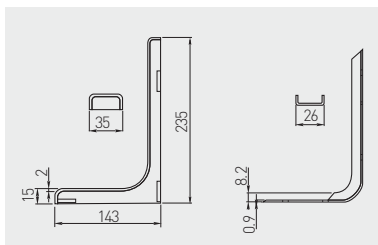

WB-WS-24-001	240	11 / 2 szt. 11 / 2 pcs. 11 / 2 шт.	chrom / chrome / хром	tworzywo plastic пластмасса
WB-WS-24-010	240		biały / white / белый	
WB-WS-24-020	240		czarny / black / чёрный	
WB-WS-24-030	240		brąz / brown / коричневый	
WB-WS-24-031	240		ciemny brąz / dark brown / темно-коричневый	
WB-WS-24-032	240		jasny brąz / light brown / светло-коричневый	
WB-WS-24-033	240		kalwados / calvados / кальвадос	
WB-WS-24-060	240		szary / gray / серый	





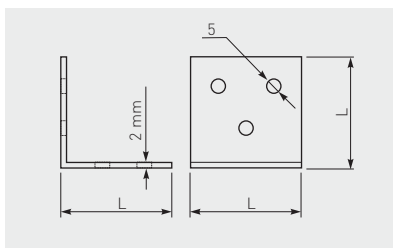



Kątownik FS01 szeroki
Angle bracket FS01
Широкий крепежный уголок FS01

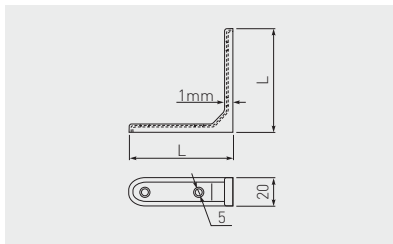

KW-FS0125-01	25 x 25 x 24	chrom / chrome / хром	stal / steel / сталь	1500
KW-FS0140-01	40 x 40 x 40			400

Kątownik FS03 wzmacniany
 Angle bracket FS03 reinforced
 Усиленный крепежный уголок FS03



	 L mm			
KW-FS0335-01	35 x 35 x 20	chrom / chrome / хром	stal / steel / сталь	1300
KW-FS0350-01	50 x 50 x 20			700
KW-FS0375-01	75 x 75 x 20			400

Kątownik FS04 standardowy
 Angle bracket FS04 standard
 Стандартный крепежный уголок FS04

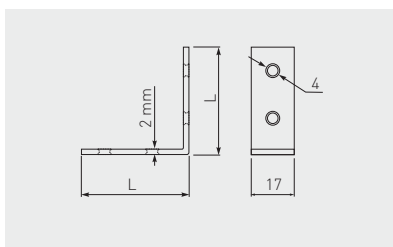

	 L mm			
KW-FS0425-03	25 x 25 x 17	mosiądz / brass / латунь	stal / steel / сталь	1500
KW-FS0430-03	30 x 30 x 17			1400
KW-FS0440-03	40 x 40 x 17			800
KW-FS0450-03	50 x 50 x 17			600
KW-FS0460-03	60 x 60 x 17			500
KW-FS0475-03	75 x 75 x 17			400

Kątownik FS06 narożnikowy
 Corner bracket FS06
 Угловой крепежный уголок FS06

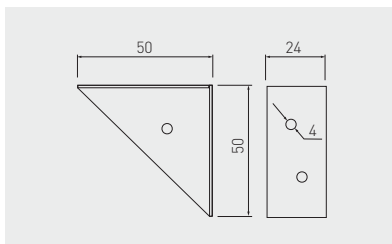

KW-FS0650-01



50 x 50 x 24



chrom / chrome / хром



stal / steel / сталь



Narożnik MONT pojedynczy
 Corner bracket MONT single
 Одинарный уголок MONT

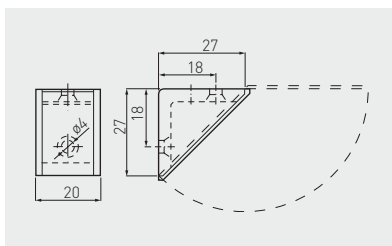

PP-PMONT0M-01

biały / white / белый



PP-PMONT0M-07

ciemny brąz / dark brown / темно-коричневый

PP-PMONT0M-08

szary / gray / серый

PP-PMONT0M-11

czarny / black / чёрный

PP-PMONT0M-20

mahoń / mahogany / красное дерево

PP-PMONT0M-22

kość stoniowa / ivory / слоновая кость

tworzywo
plastic
пластмасса

Narożnik MONT podwójny Corner bracket MONT double Двойной уголок MONT

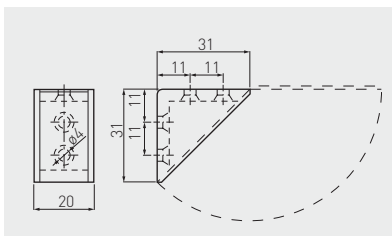

PP-PMONT0D-01	biały / white / белый	tworzywo plastic пластмасса
PP-PMONT0D-07	jasny brąz / light brown / светло-коричневый	
PP-PMONT0D-08	szary / gray / серый	
PP-PMONT0D-11	czarny / black / чёрный	
PP-PMONT0D-20	mahoń / mahogany / красное дерево	
PP-PMONT0D-22	kość stoniowa / ivory / слоновая кость	
PP-PMONT0D-41	olcha / alder / ольха	
PP-PMONT0D-50	beż / beige / бежевый	
PP-PMONT0D-724	wiśnia / cherry / вишня	
PP-PMONT0D-732	ciemny brąz / dark brown / темно-коричневый	



Narożnik NARS pojedynczy Corner bracket NARS single Одинрный уголок NARS

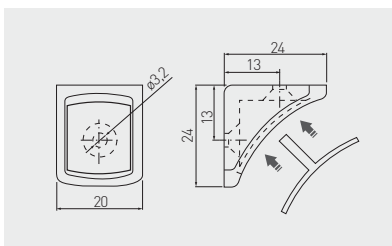

PM-NAR1003-512	kość stoniowa / ivory / слоновая кость	tworzywo plastic пластмасса
PM-NAR1003-645	szary / gray / серый	
PM-NAR1003-677	czarny / black / чёрный	
PM-NAR1003-680	biały / white / белый	
PM-NAR1003-695	srebrny / silver / серебристый	
PM-NAR1003-725	jasny brąz / light brown / светло-коричневый	
PM-NAR1003-728	beż / beige / бежевый	
PM-NAR1003-731	mahoń / mahogany / красное дерево	
PM-NAR1003-732	ciemny brąz / dark brown / темно-коричневый	
PM-NAR1003-770	grusza / pear / груша	
PM-NAR1003-771	olcha / alder / ольха	



Narożnik NARS podwójny Corner bracket NARS double Двойной уголок NARS

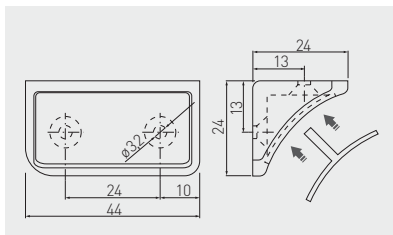

PM-NAR1004-512	kość słoniowa / ivory / слоновая кость	tworzywo plastic пластмасса
PM-NAR1004-645	szary / gray / серый	
PM-NAR1004-677	czarny / black / чёрный	
PM-NAR1004-680	biały / white / белый	
PM-NAR1004-695	aluminium / aluminium / алюминий	
PM-NAR1004-724	wiśnia / cherry / вишня	
PM-NAR1004-725	jasny brąz / light brown / светло-коричневый	
PM-NAR1004-728	beż / beige / бежевый	
PM-NAR1004-731	mahoń / mahogany / красное дерево	
PM-NAR1004-732	ciemny brąz / dark brown / темно-коричневый	
PM-NAR1004-770	grusza / pear / груша	
PM-NAR1004-771	olcha / alder / ольха	



Stabilizator ścianki tylnej Rear stabilizer Стабилизатор задней стенки

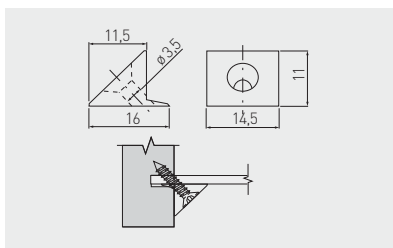

WZ-SCTYLPR-WK	z wkrętem 3,5 x 20 with screw 3,5 x 20 с шурупом 3,5 x 20	biały white белый	tworzywo plastic пластмасса
WZ-SCTYLPR-BWK	bez wkręta without screw без шурупа		



Zawieszka niewidoczna FORCE
Invisible kitchen hanger FORCE
Скрытый навес FORCE

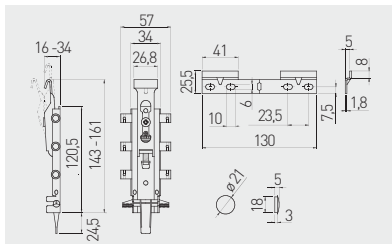

ZK-FORCE-KPL	100 / 2 szt. 100 / 2 pcs. 100 / 2 шт.	srebrny / silver / серебристый	ZnAl, stal / ZnAl, steel / ZnAl, сталь
--------------	---	--------------------------------	--



Zawieszka kuchenna R0 z regulacją
Kitchen hanger R0 adjustable
Навес кухонный R0 с регулировкой

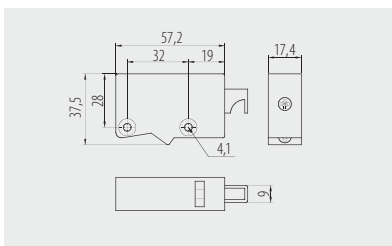

ZK-ZAW-R0-10	50 / 2 szt.	biały / white / белый	stal, tworzywo steel, plastic сталь, пластмасса
ZK-ZAW-R0-30	50 / 2 pcs.	brąz / brown / коричневый	
ZK-ZAW-R0-32	50 / 2 шт.	jasny brąz / light brown / светло-коричневый	



Zawieszka kuchenna R1 Kitchen hanger R1 Навес кухонный R1

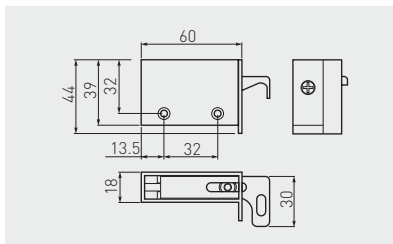

ZK-R1-KPL-10	90 / 2 szt. 90 / 2 pcs.	biały / white / белый	stal, tworzywo steel, plastic
ZK-R1-KPL-30	90 / 2 szt.	brąz / brown / коричневый	stal, plastmаса



Zawieszka kuchenna STRONG Kitchen hanger STRONG Навес кухонный STRONG

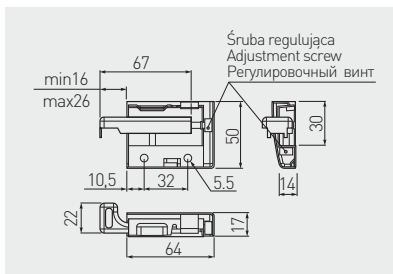





ZK-STRONG-KPL	130 / 2 szt. 130 / 2 pcs. 130 / 2 шт.	1 kpl. = L+P 1 set = L+R 1 комп. = Л+П	srebrny silver серебристый	stal, tworzywo steel, plastic сталь, пластмаса

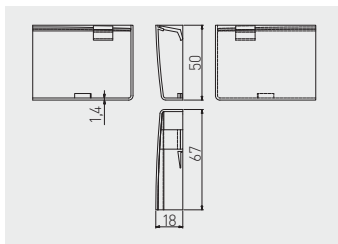

Zaślepka do zawieszki STRONG
Hanger caps STRONG
Заглушки для навесов STRONG



			
ZK-ZAS-KPL-10	1 kpl. = L+P 1 set = L+R 1 комп. = Л+П	biały / white / белый	
ZK-ZAS-KPL-31		ciemny brąz / dark brown / темно-коричневый	
ZK-ZAS-KPL-32		jasny brąz / light brown / светло-коричневый	
		tworzywo plastic пластмасса	



Listwa montażowa
Mounting strip
Монтажная планка

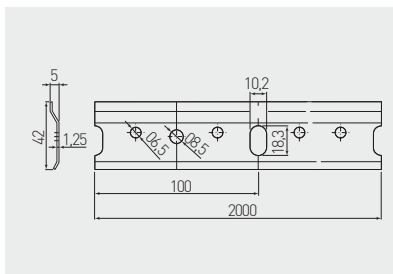

			
LO-M2M-00-125	2000	ocynk galvanized гальваника	stal steel сталь



Złącze do blatów śrubowe
Concealed worktop connector
Стяжка для столешниц

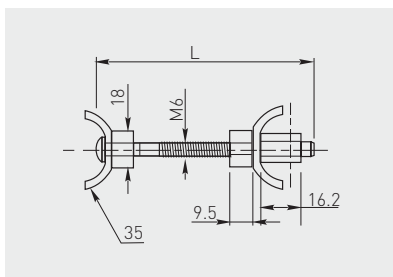

	 L mm		
EM-SBL060-01	60	chrom / chrome / хром	stal, tworzywo steel, plastic сталь, пластмасса
EM-SBL100-01	100		
EM-SBL150-01	150		



Złącze mimośrodkowe
Eccentric connecting fitting
Эксцентрик

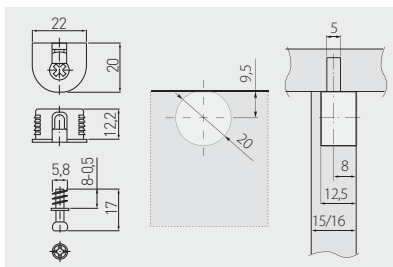

	 mm			
MM-FI20X6X7-PL10	20	trzpień 6x7mm dowel 6x7mm штифт 6x7мм	biały / white / белый	ZnAl, tworzywo ZnAl, plastic ZnAl, пластмасса
MM-FI20X6X7-PL20			czarny / black / чёрный	
MM-FI20X6X7-PL30			brąz / brown / коричневый	
MM-FI20X6X7-PL80			szary / gray / серый	
MM-FI20X6X7-ZN			srebrny / silver / серебристый	



Złącze mimośrodowe do półek
 Eccentric connecting fitting for shelves
 Экцентриковая стяжка для полок

NEW



	 mm		
MM-FI20-KPL	Ø 20	biały / white / белый	stal, tworzywo steel, plastic сталь, пластмасса



Złącze do półek z zabezpieczeniem
 Shelf connecting fitting with lock
 Полкодержатель с защитной планкой

NEW

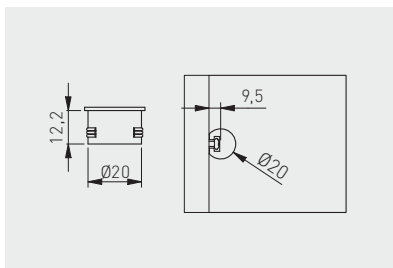

	 BOARD mm		
PP-FI20-16-KPL	16	biały / white / белый	stal, tworzywo steel, plastic сталь, пластмасса
PP-FI20-18-KPL	18		



Złącze spiralne fi 35 do mocnych połączeń Spiral connector, Fi 35, for strong connections Крепеж спиральный диаметром 35 для прочных соединений

NEW

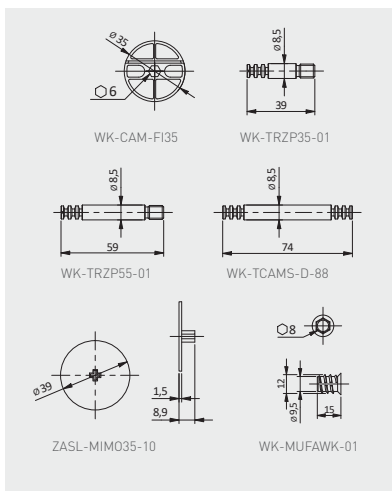



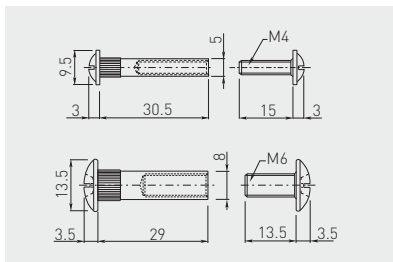

WK-CAM-FI35	Złącze spiralne fi 35 do mocnych połączeń Spiral connector, Fi 35, for strong connections Крепеж спиральный диаметром 35 для прочных соединений	szary / gray / серый		
WK-MUFAWK-01	Mufa wkręcana z kotnierzem stożkowym M8x15 Screwed cone nut M8x15 Муфта ввинчиваемая с конусным фланцем M8x15			
WK-TCAMS-D-88	Trzpień dwustronny do złącza spiralnego M8 L35 Double bolt for spiral connector M8 L35 Шток двухсторонний для спирального крепежа M8 L35	srebrny silver серебристый	stal steel сталь	100
WK-TRZP35-01	Trzpień do złącza spiralnego M8 L35 Bolt for spiral connector M8 L35 Шток для спирального крепежа M8 L35			
WK-TRZP55-01	Trzpień do złącza spiralnego M8 L55 Bolt for eccentric connecting fitting M8 L55 Шток эксцентрика M8 L55			
ZASL-MIM035-10	Zaślepka fi 35 end cap fi 35 заглушка fi 35	biały / white / белый	tworzywo plastic пластмасса	

Szybkozłącze Threaded sleeve, with internal thread Стяжки

NEW





SZ-005-00-01
SZ-008-00-01SZ-005-00-01-A
SZ-008-00-01-A



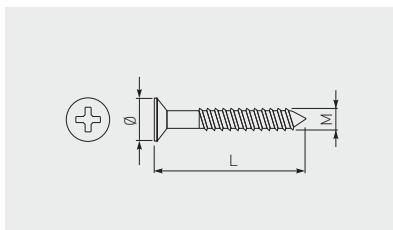

		 mm		
SZ-005-00-01		5	chrom / chrome / хром	stal / steel / сталь
SZ-005-00-01-A				
SZ-008-00-01		8		
SZ-008-00-01-A				



Wkręt do drewna Screw for wood Мебельные метизы



		 mm		
WK-D0310-001		3 x 10	chrom chrome хром	stal steel сталь
WK-D0313-001		3 x 13		
WK-D0316-001		3 x 16		
WK-D0320-001*		3 x 20		
WK-D0325-001*		3 x 25		
WK-D0330-001*		3 x 30		
WK-D0416-001		4 x 16		
WK-D0425-001*		4 x 25		

		 mm		
WK-D0430-001		4 x 30	chrom chrome хром	stal steel сталь
WK-D0440-001*		4 x 40		
WK-D0460-001*		4 x 60		
WK-D3516-001		3,5 x 16		
WK-D3525-001		3,5 x 25		
WK-D3530-001		3,5 x 30		

*Produkt dostępny na indywidualne zamówienie
Available for special orders
Товар доступен под заказ



Mimośród FI15X12mm
 Eccentric connecting fitting FI15X12mm
 Эксцентрик FI15X12mm

NEW

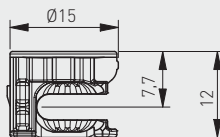

WK-CAM15-12-P



Ø 15 x 12



chrom / chrome / хром



ZnAl



Trzpień do mimośrodu
 Bolt for eccentric connecting fitting
 Шток эксцентрика

NEW

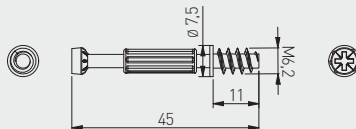

WK-DOW63X45-P



6,3X45



srebrny, niebieski
 silver, blue
 серебряный, синий



stal, tworzywo
 steel, plastic
 сталь, пластмасса



Konfirmat*
 Confirmat screw*
 Конфирмат*

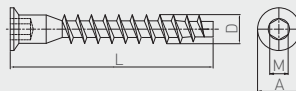

	L	D	A	M
WK-CF6450-01	6,4 x 50	50	6,4	9,5
WK-CF0750-01	7 x 50	50	7	10



WK-CF6450-01	chrom / chrome / хром	stal / steel / сталь
WK-CF0750-01		



*Produkt dostępny na indywidualne zamówienie / Available for special orders / Товар доступен под заказ

Magnes MENSA
 Magnetic catch MENSA
 Магнит MENSA

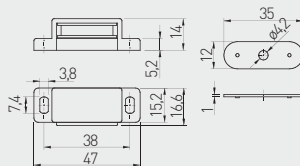





MG-MENSA-010	biały / white / белый	stal, tworzywo steel, plastic сталь, пластмасса
MG-MENSA-030	brąz / brown / коричневый	

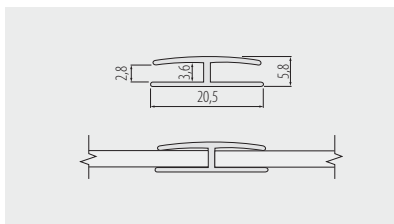

Profil meblowy PFM - typ H
 Furniture edge profile PFM - type H
 Мебельный профиль PFM - тип H





	 L mm		
PM-PFMH51-10*	2000	ciemny brąz / dark brown / темно-коричневый	tworzywo plastic пластмасса
PM-PFMH53-10	2000	jasny brąz / light brown / светло-коричневый	
PM-PFMH61-10*	2000	ciemny mahoń / dark mahogany / темное красное дерево	
PM-PFMH64-10	2000	mahoń / mahogany / красное дерево	
PM-PFMH69-10	2000	beż / beige / бежевый	
PM-PFMH50-24*	2400	biały / white / белый	
PM-PFMH50-25*	2500	biały / white / белый	
PM-PFMH55-25*	2500	czarny / black / чёрный	
PM-PFMH64-25*	2500	mahoń / mahogany / красное дерево	

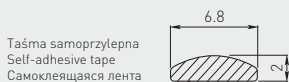

*Produkt dostępny na indywidualne zamówienie / Available for special orders / Товар доступен под заказ

Listwa ozdobna płaska
Flat decorative strip
Плоская декоративная планка



	 mm		
LO-00-00-001	2000	chrom / chrome / хром	tworzywo plastic пластмасса
LO-00-00-003	2000	mosiądz / brass / латунь	



Listwa ozdobna wypukła
Convex decorative strip
Выпуклая декоративная планка

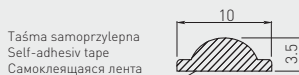





	 mm		
LO-P0-00-010	2000	biały / white / белый	tworzywo plastic пластмасса
LO-P0-00-030	2000	brąz / brown / коричневый	

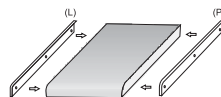

Listwa boczna 38
Worktop edging strip 38
Торцевая планка 38



Do blatów o grubości 38 mm
For worktops 38 mm thick
Для столешниц толщиной 38 мм

				
LMB-BOCZ38L-ALU	lewa / left / левая	600	aluminium aluminium алюминий	aluminium aluminium алюминий
LMB-BOCZ38P-ALU	prawa / right / правая			



Listwa kątowna 28
Worktop angle edging strip 28
Угловая планка 28

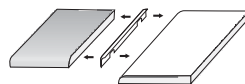

Do blatów o grubości 28 mm
For worktops 28 mm thick
Для столешниц толщиной 28 мм

			
LMB-KAT28-ALU	600	aluminium aluminium алюминий	aluminium aluminium алюминий



Listwa kątowa 38
Worktop angle edging strip 38
Угловая планка 38

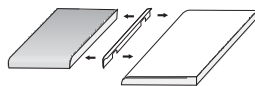

Do blatów o grubości 38 mm
For worktops 38 mm thick
Для столешниц толщиной 38 мм

	 L mm		
LMB-KAT38-ALU	600	aluminium aluminium алюминий	aluminium aluminium алюминий



Listwa szczelinowa 28
Worktop joining strip 28
Щелевая планка 28

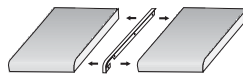

Do blatów o grubości 28 mm
For worktops 28 mm thick
Для столешниц толщиной 28 мм

	 L mm		
LMB-SZCZ28-ALU	600	aluminium aluminium алюминий	aluminium aluminium алюминий



Listwa szczelinowa 38
Worktop joining strip 38
Щелевая планка 38

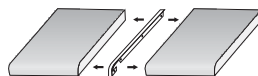

Do blatów o grubości 38 mm
For worktops 38 mm thick
Для столешниц толщиной 38 мм

	 L 600 mm		
LMB-SZCZ38-ALU	600	aluminium aluminium алюминий	aluminium aluminium алюминий



Drążek owalny
Oval wardrobe rail
Овальная труба для гардероба

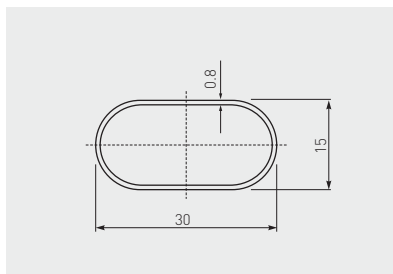

	 L 3000 mm		
RR-CH-OW-000	3000	chrom / chrome / хром	stal / steel / сталь



Mocowanie RDR do drążka owalnego
RDR mounting bracket for oval wardrobe rail
Крепление RDR для овальной трубы

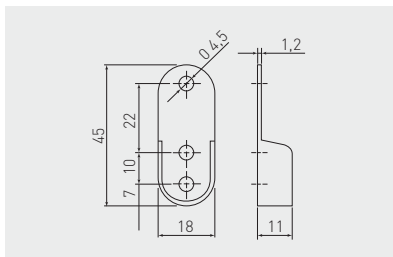

MR-RDR0-0000



chrom / chrome / хром



stal / steel / сталь



Uchwyt WP-28 do rury owalnej
WP-28 angle bracket for oval rail
Крепление дистанционное для овальной трубы

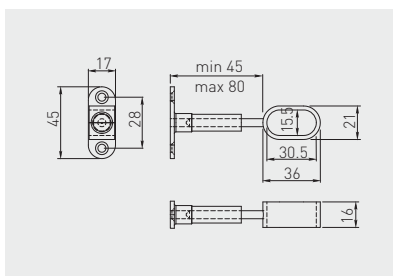

MR-WP-028-01



chrom / chrome / хром





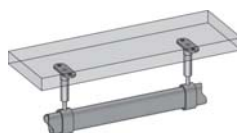



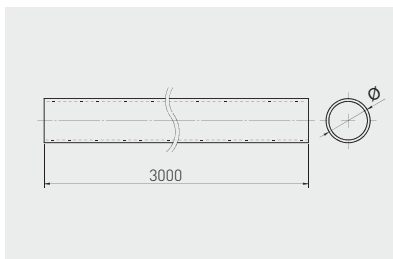



ZnAl



Drażek okrągły
Round wardrobe rail
Мебельная штанга



		 mm	 mm	 mm		
RR-161030H01		16	1	3000	chrom chrome хром	stal steel сталь
RR-161230H01		16	1,2			
RR-250730H01		25	0,7			
RR-250830H01		25	0,8			
RR-250930H01		25	0,9			

		 mm	 mm	 mm		
RR-251030H01		25	1	3000	chrom chrome хром	stal steel сталь
RR-401230H01*		40	1,2			
RR-501030H01		50	1			
RR-501230H01		50	1,2			



*Produkt dostępny na indywidualne zamówienie / Available for special orders / Товар доступен под заказ

Mocowanie R-25 do drążka okrągłego
R-25 mounting bracket for round rail
Крепление R-25 для трубы

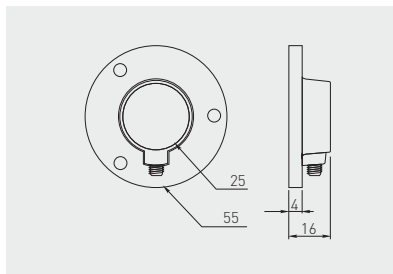



		 mm		
MR-RS025-001		25	chrom / chrome / хром	stal / steel / сталь

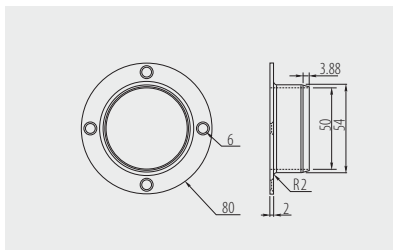

Монтованіе R-50 до дражка округлого
R-50 mounting bracket for round rail
Крепление R-50 для трубы







	 mm		
MR-R0050-001	50	chrom / chrome / хром	stal / steel / сталь

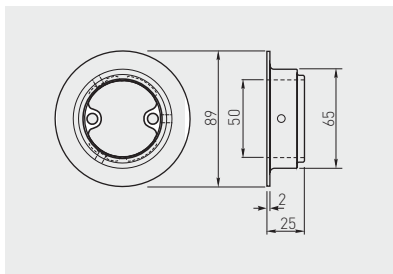

Монтованіе PZ-2 долне до дражка округлого
PZ-2 bottom mounting bracket for round rail
Нижнее крепление PZ-2 для трубы



	 mm		
MR-WPZ002-01	50	chrom / chrome / хром	stal / steel / сталь



Pierścień mocujący PZ-3
Mounting ring PZ-3
Крепёжное кольцо PZ-3

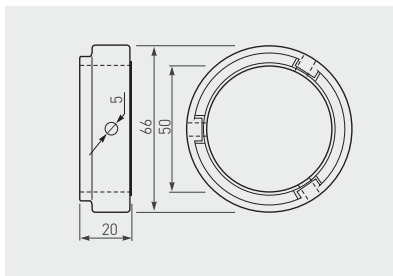

MR-WPZ003-01



50



chrom / chrome / хром



ZnAl



Uchwyt WP-10 dystansowy, regulowany
WP-10 support bracket, adjustable
Регулируемый кронштейн WP-10

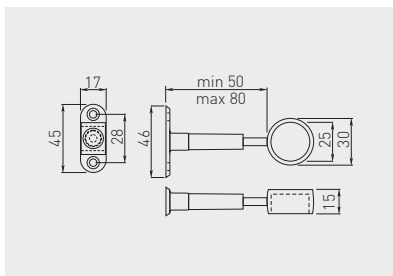

MR-WP-010-01



25



chrom / chrome / хром



ZnAl



Uchwyt WP-11 dystansowy, regulowany z zaślepką
 WP-11 support bracket, adjustable with cover
 Регулируемый кронштейн WP-11 с заглушкой

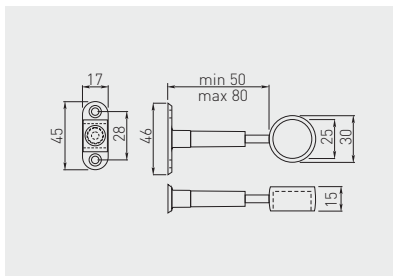

MR-WP-011-01



25



chrom / chrome / хром



ZnAl



Uchwyt THA-12 dystansowy, przelotowy
 THA-12 support bracket
 Опорный кронштейн THA-12 сквозной

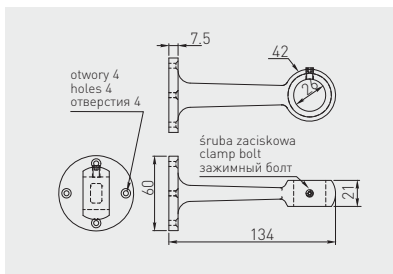

MR-THA12-001



25



chrom / chrome / хром



ZnAl



Uchwyt THB-12 dystansowy
 THB-12 support bracket
 Опорный кронштейн THB-12

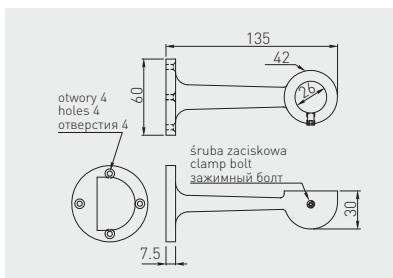

	 mm		
MR-THB12-001	25	chrom / chrome / хром	ZnAl



Łącznik WP-13
 WP-13 connector
 Соединитель WP-13

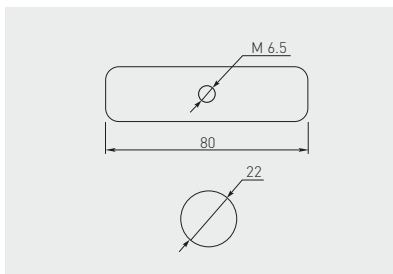

		
MR-WP013-001	osynk / galvanized / гальваника	ZnAl



Złącze TH-5 dwuramienne
 TH-5 connector
 Муфта TH-5 двухраструбная

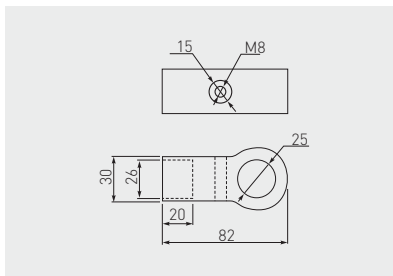

	 mm		
MR-TH005-001	25	chrom / chrome / хром	ZnAl



Złącze TH-16 dwuramienne
 TH-16 connector
 Муфта двухраструбная TH-16

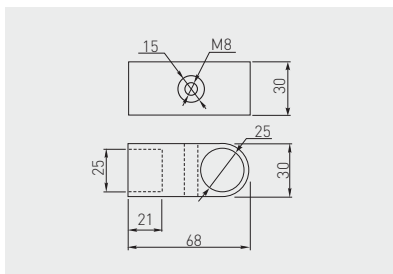

	 mm		
MR-TH016-001	25	chrom / chrome / хром	ZnAl



Złącze TH-4 dwuramienne typ T
 TH-4 connector type T
 Муфта TH-4 двухраструбная тип T

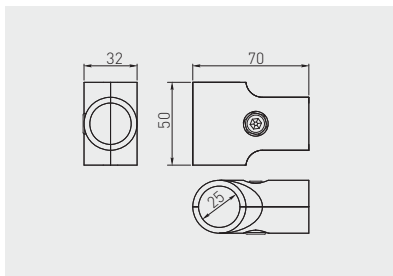

MR-TH004-001

25

chrom / chrome / хром

ZnAl



Zestaw złączy TH-18 typ L
 TH-18 connector type L
 Набор муфт TH-18 тип L

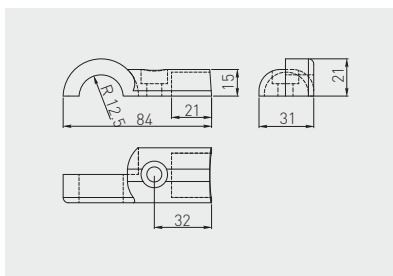

Możliwość uzyskania różnych pozożeń połączenia
 The possibility of obtaining various positions of connection
 Возможность получения разных положений соединения



MR-TH018-KPL

prawy / lewy
 right / left
 правый / левый

25

chrom / chrome / хром

ZnAl



Zestaw złączy T-18 typ T
T-18 connectors set type T
Набор муфт ТН-18 тип Т

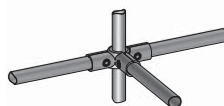
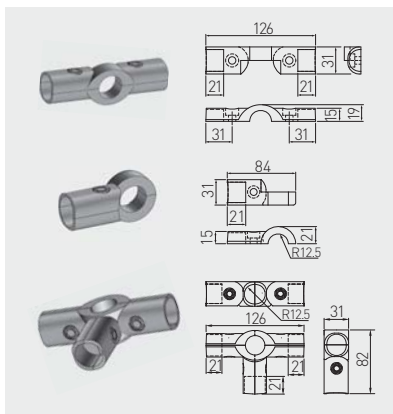

MR-T1824-KPL

25

chrom / chrome / хром

ZnAl

x 60



Zestaw złączy TH-24
TH-24 connectors set
Набор муфт ТН-24

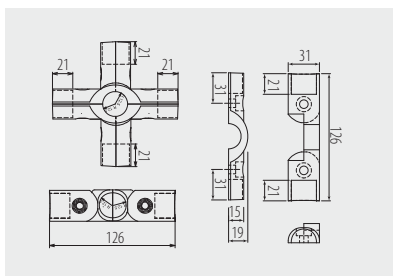

MR-TH024-KPL

25

chrom / chrome / хром

ZnAl

x 40



Złącze TH-11 zawiasowe
TH-11 hinge connector
Муфта шарнирная TH-11

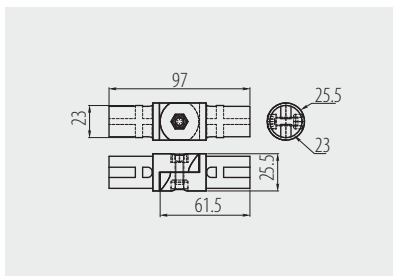

Możliwość dostosowania kąta złączy do założonego położenia (do 180°)

The possibility of adjustment of angle connector arms to the desired position (up to 180°)

Возможность регулировки угла стыковки соединителей к заданному положению (180°)



MR-TH011-001



chrom / chrome / хром



ZnAl



Złącze TH-9
TH-9 connector
Муфта TH-9

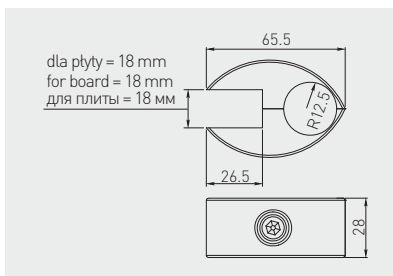

dla płyty = 18 mm
for board = 18 mm
для плиты = 18 мм



MR-TH009-001



chrom / chrome / хром



ZnAl



Zalecana grubość szkła z użyciem wkładek: od 4 do 8 mm
Recommended glass thickness with inserts: from 4 to 8 mm

Рекомендуемая толщина стекла с использованием вкладышей: от 4 до 8 мм

Złącze TH-10 dwustronne
TH-10 connector
Муфта TH-10 двухсторонняя

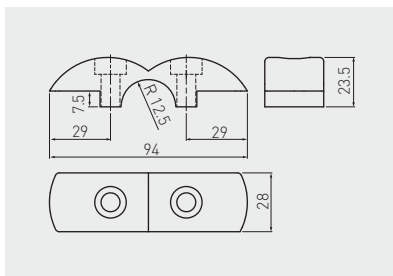

MR-TH010-001

chrom / chrome / хром

ZnAl



Zalecana grubość szkła z użyciem wkładek: od 4 do 8 mm
Recommended glass thickness with inserts: from 4 to 8 mm
Рекомендуемая толщина стекла с использованием вкладышей: от 4 до 8 мм

Zestaw złączy TH-35
TH-35 set of connectors
Набор муфт TH-35

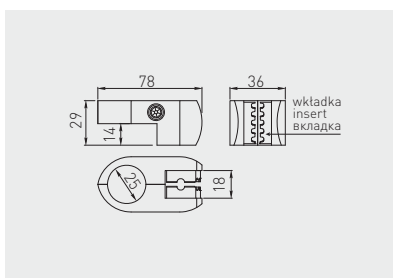

MR-TH035-KPL

25

chrom / chrome / хром

ZnAl



Zalecana grubość szkła z użyciem wkładek: od 4 do 8 mm
Recommended glass thickness with inserts: from 4 to 8 mm
Рекомендуемая толщина стекла с использованием вкладышей: от 4 до 8 мм

Złącze WP-14 dwustronne
 WP-14 connector
 Муфта WP-14 двухсторонняя

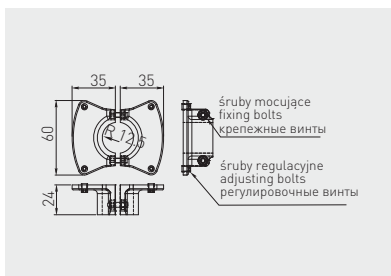

MR-WP-14-KPL

25

chrom / chrome / хром

ZnAl

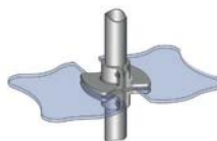

Złącze WP-15
 WP-15 connector
 Муфта WP-15

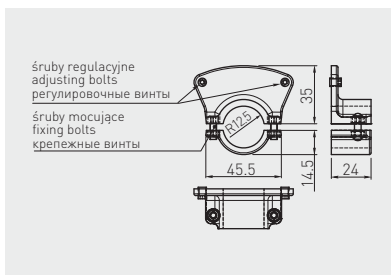

MR-WP-15-KPL

25

chrom / chrome / хром

ZnAl

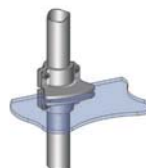

Złącze TH-1 równoległe
TH-1 connector parallel
Муфта TH-1 равнопроходная

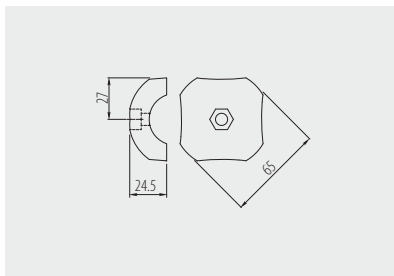

MR-TH001-01

chrom / chrome / хром

ZnAl

x 100



Złącze TH-2 potrójne
TH-2 connector three-way
Муфта TH-2 тройная

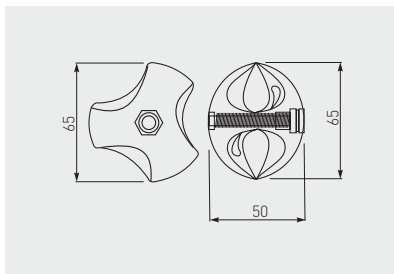

MR-TH002-L01

lewy / left / левый

MR-TH002-P01

prawy / right / правый

chrom / chrome / хром



ZnAl

x 100

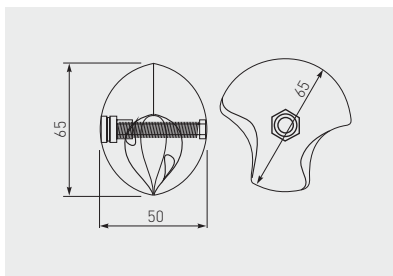

Złącze TH-18 podwójne
TH-18 double connector
Муфта TH-18 двойная



			
MR-TH018-L01	lewy / left / левый	chrom / chrome / хром	ZnAl
MR-TH018-P01	prawy / right / правый		



Zaślepka okrągła
Round end cap
Круглая заглушка

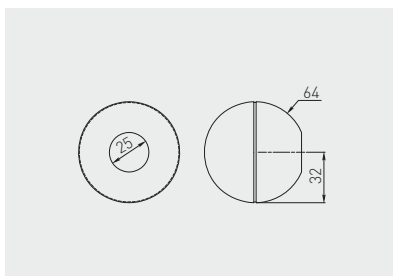

			
MR-THQZ1-001	25	chrom / chrome / хром	ZnAl



Zaślepka TH-19
TH-19 end cap
Заглушка TH-19

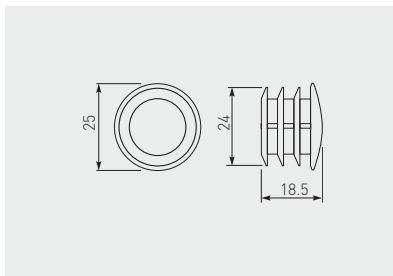

	 mm		
MR-TH019-001	25	chrom / chrome / хром	ZnAl



Stopka plastikowa zewnętrzna
Plastic end cap
Внешняя ножка, пластмассовая

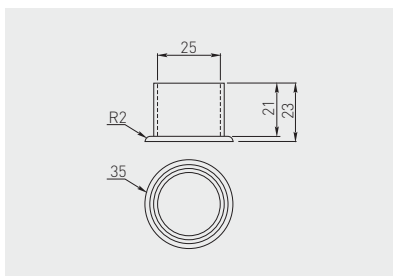

	 mm		
MR-TH019-003	25	czarny black чёрный	tworzywo plastic пластмасса



Uchwyt THA-48 z przysawką
 THA-48 handle with suction cup
 Крепление THA-48 с присоской

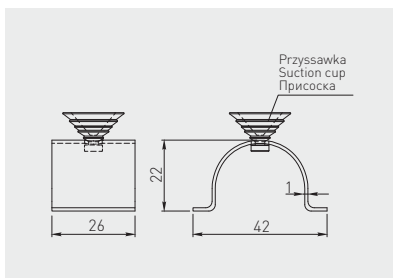

	 mm		
MR-TH048-001	25	chrom chrome хром	stal, tworzywo steel, plastic сталь, пластмасса

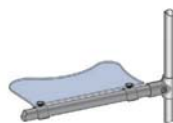

Mocowanie PZ-6 górne, rozporowe
 PZ-6 expandable end support bracket
 Верхнее крепление PZ-6

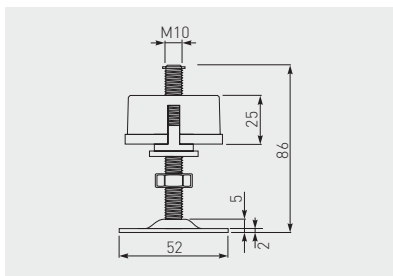

	 mm		
MR-WPZ006-01	50	chrom / chrome / хром	stal, tworzywo / steel, plastic / сталь, пластмасса



Uchwyt do relingu prosty
 Rail support
 Ручка для рейлинга прямая

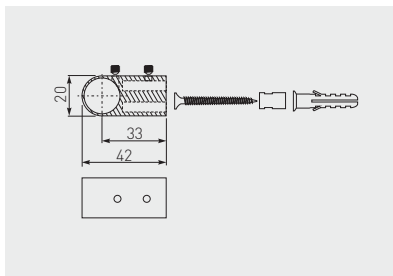

MR-WP2802-01



16



chrom / chrome / хром



ZnAl

x 300



Zaślepka do relingu prosta
 End cap
 Заглушка для рейлинга прямая

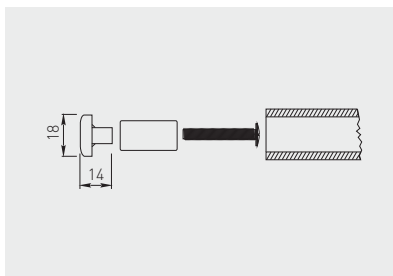

MR-WP2815-01



16



chrom / chrome / хром



ZnAl

x 600



Uchwyt do relingu
Rail support
Ручка для рейлинга

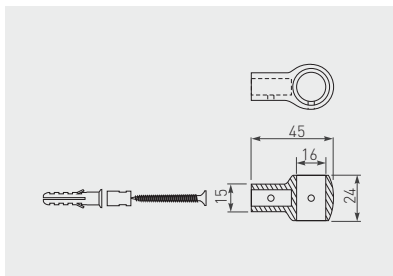

MR-WP2804-01

16

chrom / chrome / хром

ZnAl

x 300



Zaślepka do relingu
End cap
Заглушка для рейлинга

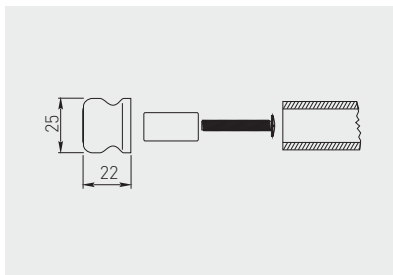

MR-WP2806-01

16

chrom / chrome / хром

ZnAl, tworzywo / ZnAl, plastic / ZnAl, пластмасса

x 600



Łącznik do relingu
 Rail connector
 Соединитель для рейлинга

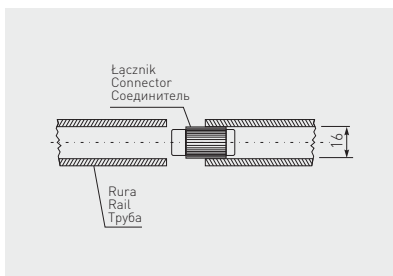

	 mm		
MR-WP2807-20	16	czarny / black / чёрный	tworzywo / plastic / пластмасса



Zaślepka do relingu z gwintem
 End cap with thread for rails
 Заглушка для рейлинга с резьбой

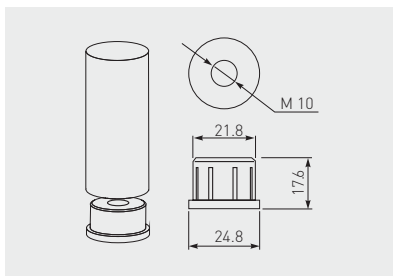

		
MR-WPZ023-01	chrom / chrome / хром	ZnAl



Начыкі до релінгу PS1
 Hooks for rails PS1
 Крючки для рейлінга PS1

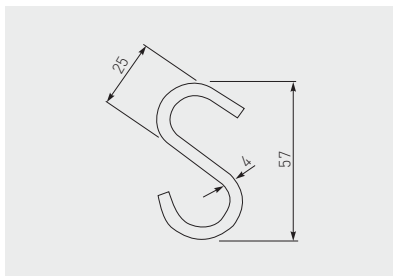

	 mm		
MR-WPS01-001	16	chrom / chrome / хром	stal / steel / сталь



Начыкі до релінгу PS3
 Hooks for rails PS3
 Крючки для рейлінга PS3

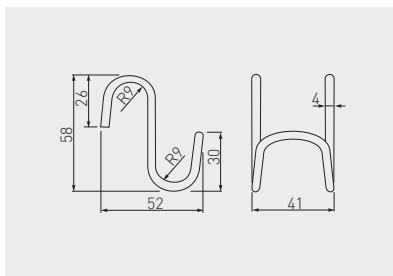







	 mm		
MR-WPS03-001	16	chrom / chrome / хром	stal / steel / сталь

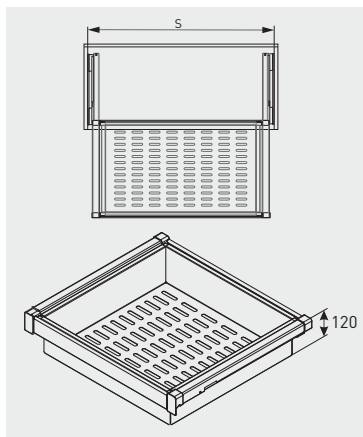

Kosz metalowy ELITE
Metal basket ELITE
Металлическая корзина ELITE

NEW







	S min/max			
WG-KOSZM60-10	560-618	pełny full полное		
WG-KOSZM70-10	660-718			
WG-KOSZM80-10	760-818			
WG-KOSZM90-10	860-918			
WG-KOSZM60-60	560-618			
WG-KOSZM70-60	660-718			
WG-KOSZM80-60	760-818			
WG-KOSZM90-60	860-918			
			biały white белый	
			antracyt anthracite антрацит	stal, tworzywo steel, plastic сталь, пластмасса

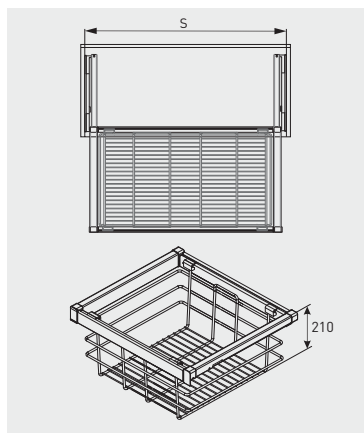

Kosz ażurowy ELITE
Openwork basket ELITE
Ажурная корзина ELITE

NEW







	S min/max			
WG-KOSZ60-10	560-618	pełny full полное	biały white белый	stal, tworzywo steel, plastic сталь, пластмасса
WG-KOSZ70-10	660-718			
WG-KOSZ80-10	760-818			
WG-KOSZ90-10	860-918			
WG-KOSZ60-60	560-618		antracyt anthracite антрацит	
WG-KOSZ70-60	660-718			
WG-KOSZ80-60	760-818			
WG-KOSZ90-60	860-918			

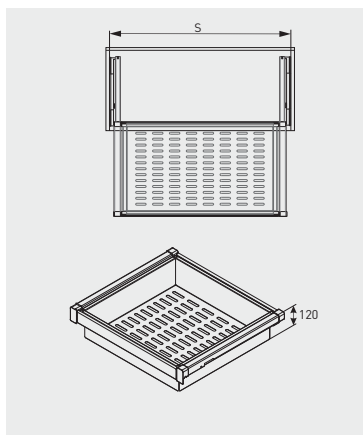

Kosz rattanowy ELITE
Rattan basket ELITE
Плетеная из rattana корзина ELITE

NEW







	 S min/max			
WG-KOSZR60-10	560-618	petny full полное	biały white белый	stal, tworzywo steel, plastic сталь, пластмасса
WG-KOSZR70-10	660-718			
WG-KOSZR80-10	760-818			
WG-KOSZR90-10	860-918			
WG-KOSZR60-60	560-618		antracyt anthracite антрацит	
WG-KOSZR70-60	660-718			
WG-KOSZR80-60	760-818			
WG-KOSZR90-60	860-918			

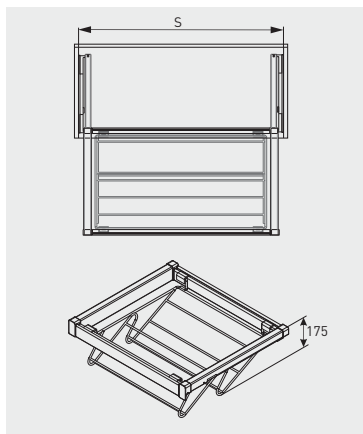

Szuflada na obuwie ELITE
Pull out shoes rack ELITE
Полка для обуви ELITE

NEW



	 S min/max			
WG-POBUW60-10	560-618	pełny full полное	biały white белый	stal, tworzywo steel, plastic сталь, пластмасса
WG-POBUW70-10	660-718			
WG-POBUW80-10	760-818			
WG-POBUW90-10	860-918			
WG-POBUW60-60	560-618		antracyt anthracite антрацит	
WG-POBUW70-60	660-718			
WG-POBUW80-60	760-818			
WG-POBUW90-60	860-918			



Szuflada na obuwie metalowa ELITE
 Metal pull out shoes rack ELITE
 Металлическая полка для обуви ELITE

NEW

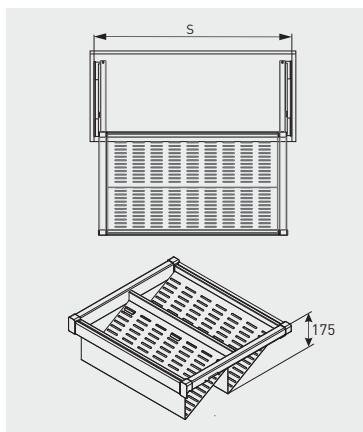

S
min/max









WG-POBUWM60-10	560-618	pełny full полное	biały white белый	stal, tworzywo steel, plastic сталь, пластмасса
WG-POBUWM70-10	660-718			
WG-POBUWM80-10	760-818			
WG-POBUW90M-10	860-918			
WG-POBUW60M-60	560-618		antracyt anthracite антрацит	
WG-POBUW70M-60	660-718			
WG-POBUW80M-60	760-818			
WG-POBUW90M-60	860-918			

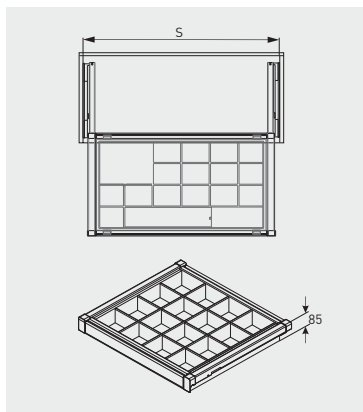

Organizer ELITE
Organiser ELITE
Органайзер ELITE

NEW







	S min/max			
WG-PRZEG60-10	560-618	pełny full полное		
WG-PRZEG70-10	660-718			
WG-PRZEG80-10	760-818			
WG-PRZEG90-10	860-918			
WG-PRZEG60-60	560-618			
WG-PRZEG70-60	660-718			
WG-PRZEG80-60	760-818			
WG-PRZEG90-60	860-918			
				biały white белый
				antracyt anthracite антрацит
				stal, tworzywo steel, plastic сталь, пластмасса

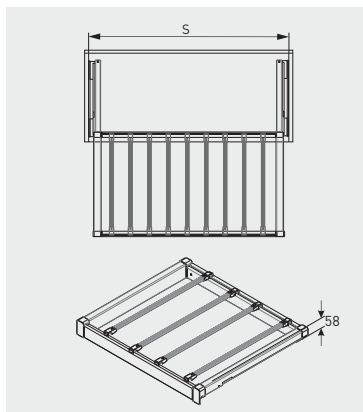

Wieszak na spodnie ELITE
 Wardrobe trouser rack ELITE
 Вешалка для брюк ELITE

NEW



	S min/max			
WG-WSP0D60-10	560-618	pełny full полное	biały white белый	stal, tworzywo steel, plastic сталь, пластмасса
WG-WSP0D70-10	660-718			
WG-WSP0D80-10	760-818			
WG-WSP0D90-10	860-918			
WG-WSP0D60-60	560-618		antracyt anthracite антрацит	
WG-WSP0D70-60	660-718			
WG-WSP0D80-60	760-818			
WG-WSP0D90-60	860-918			



Drażek okrągły
Round wardrobe rail
Круглая мебельная штанга

NEW

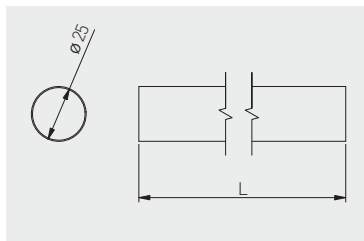

	 L mm		
RR-250930H10	3000	biały white белый	stal steel
RR-250930H60		antracyt anthracite антрацит	stal steel



Rozetka okrągła
Wardrobe rail socket
Монтажный крепеж

NEW

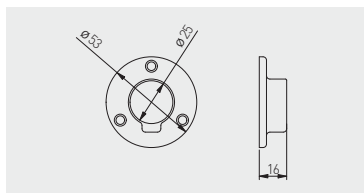





		
MR-RS025-10	biały white белый	stal steel
MR-RS025-60	antracyt anthracite антрацит	

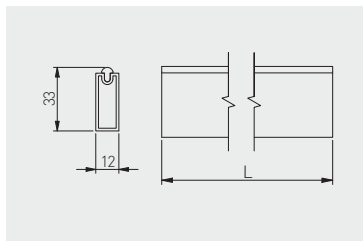

Drażek prostokątny
Rectangular wardrobe rail
Прямоугольная мебельная штанга

NEW







		 mm		
WG-RRPS300-10		3000	biały white белый	stal, tworzywo steel, plastic сталь, пластмасса
WG-RRPS300-60			antracyt anthracite антрацит	

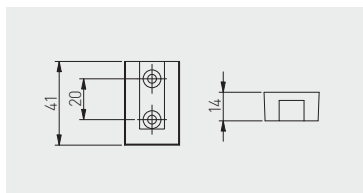

Rozetka prostokątna
Rectangular wardrobe rail socket
Прямоугольный монтажный крепеж

NEW



				
WG-RDRP-10		rozetka prostokątna z zaślepką rectangular wardrobe rail socket with end cap прямоугольный монтажный крепеж с заглушкой	biały white белый	ZnAl, tworzywo ZnAl, plastic ZnAl, пластмасса
WG-RDRP-60			antracyt anthracite антрацит	
WG-RDRO-10		rozetka prostokątna bez zaślepki rectangular wardrobe rail socket without end cap прямоугольный монтажный крепеж без заглушки	biały white белый	stal steel сталь
WG-RDRO-60			antracyt anthracite антрацит	



Pantograf z podnośnikiem olejowym
 Pull-down wardrobe rail – oil
 Пантограф с масляным подъемником

NEW

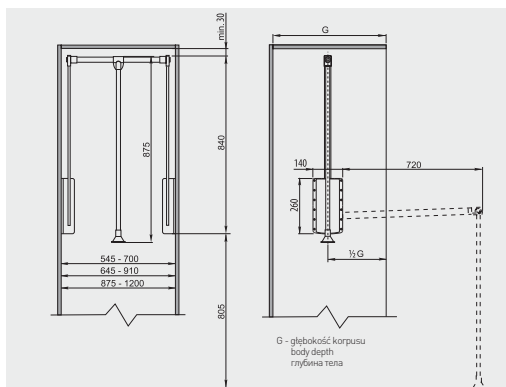

	mm	kg		
PG-ST83115-10A	975-1200	8	biały white белый	stal steel сталь
PG-ST6083-10A	645-910			
PG-ST4560-10A	545-700			
PG-ST83115-60	975-1200		antracyt anthracite антрацит	
PG-ST6083-60	645-910			
PG-ST4560-60	545-700			





Szublada SMART na obuwanie
 Pull out shoes rack SMART
 Полка SMART для обуви

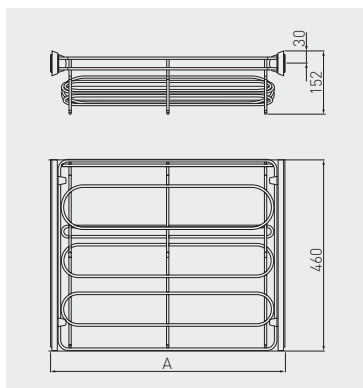

A
min/max



		mm		A min/max		
W-WOBU60-BP-60	komplet bez prowadnic set without slides комплексция без направляющих	600	pełny full	560-568	szary gray серый	stal, tworzywo steel, plastic сталь, пластмасса
W-WOBU60-GX-60	na prowadnicy kulkowej H45 on ball bearing slide H45 на шариковой направляющей H45					
W-WOBU60-VE-60	na prowadnicy kulkowej H45 z funkcją cichego zamknięcia on ball bearing slide H45 with soft closing на шариковой направляющей H45 с доводчиком					
W-WOBU70-BP-60	komplet bez prowadnic set without slides комплексция без направляющих	700	pełny full	660-668		
W-WOBU70-GX-60	na prowadnicy kulkowej H45 on ball bearing slide H45 на шариковой направляющей H45					
W-WOBU70-VE-60	na prowadnicy kulkowej H45 z funkcją cichego zamknięcia on ball bearing slide H45 with soft closing на шариковой направляющей H45 с доводчиком					
W-WOBU80-BP-60	komplet bez prowadnic set without slides комплексция без направляющих	800	pełny full	760-768		
W-WOBU80-GX-60	na prowadnicy kulkowej H45 on ball bearing slide H45 на шариковой направляющей H45					
W-WOBU80-VE-60	na prowadnicy kulkowej H45 z funkcją cichego zamknięcia on ball bearing slide H45 with soft closing на шариковой направляющей H45 с доводчиком					
W-WOBU90-BP-60	komplet bez prowadnic set without slides комплексция без направляющих	900	pełny full	860-868		
W-WOBU90-GX-60	na prowadnicy kulkowej H45 on ball bearing slide H45 на шариковой направляющей H45					
W-WOBU90-VE-60	na prowadnicy kulkowej H45 z funkcją cichego zamknięcia on ball bearing slide H45 with soft closing на шариковой направляющей H45 с доводчиком					





A
min/max



W-WOBU60-BP-10	komplet bez prowadnic set without slides комплексция без направляющих	600	petny full полное	biały white белый	stal, tworzywo steel, plastic сталь, пластмасса
W-WOBU60-GX-10	na prowadnicy kulkowej H45 on ball bearing slide H45 на шариковой направляющей H45				
W-WOBU60-VE-10	na prowadnicy kulkowej H45 z funkcją cichego zamknięcia on ball bearing slide H45 with soft closing на шариковой направляющей H45 с доводчиком				
W-WOBU70-BP-10	komplet bez prowadnic set without slides комплексция без направляющих	700	petny full полное	biały white белый	stal, tworzywo steel, plastic сталь, пластмасса
W-WOBU70-GX-10	na prowadnicy kulkowej H45 on ball bearing slide H45 на шариковой направляющей H45				
W-WOBU70-VE-10	na prowadnicy kulkowej H45 z funkcją cichego zamknięcia on ball bearing slide H45 with soft closing на шариковой направляющей H45 с доводчиком				
W-WOBU80-BP-10	komplet bez prowadnic set without slides комплексция без направляющих	800	petny full полное	biały white белый	stal, tworzywo steel, plastic сталь, пластмасса
W-WOBU80-GX-10	na prowadnicy kulkowej H45 on ball bearing slide H45 на шариковой направляющей H45				
W-WOBU80-VE-10	na prowadnicy kulkowej H45 z funkcją cichego zamknięcia on ball bearing slide H45 with soft closing на шариковой направляющей H45 с доводчиком				
W-WOBU90-BP-10	komplet bez prowadnic set without slides комплексция без направляющих	900	petny full полное	biały white белый	stal, tworzywo steel, plastic сталь, пластмасса
W-WOBU90-GX-10	na prowadnicy kulkowej H45 on ball bearing slide H45 на шариковой направляющей H45				
W-WOBU90-VE-10	na prowadnicy kulkowej H45 z funkcją cichego zamknięcia on ball bearing slide H45 with soft closing на шариковой направляющей H45 с доводчиком				

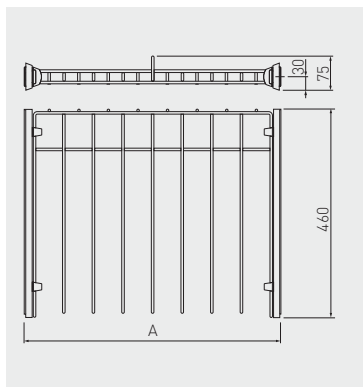

Wieszak SMART na spodnie
 SMART wardrobe trouser rack
 Вешалка SMART для брюк

 A
 min/max

W-WSPD60-BP-60	komplet bez prowadnic set without slides комплексия без направляющих	600	560 - 568	pełny full полное	szary gray серый	stal, tworzywo steel, plastic сталь, пластмасса
W-WSPD60-GX-60	na prowadnicy kulkowej H45 on ball bearing slide H45 на шариковой направляющей H45					
W-WSPD60-VE-60	na prowadnicy kulkowej H45 z funkcją cichego zamknięcia on ball bearing slide H45 with soft closing на шариковой направляющей H45 с доводчиком					
W-WSPD70-BP-60	komplet bez prowadnic set without slides комплексия без направляющих	700	660 - 668			
W-WSPD70-GX-60	na prowadnicy kulkowej H45 on ball bearing slide H45 на шариковой направляющей H45					
W-WSPD70-VE-60	na prowadnicy kulkowej H45 z funkcją cichego zamknięcia on ball bearing slide H45 with soft closing на шариковой направляющей H45 с доводчиком					
W-WSPD80-BP-60	komplet bez prowadnic set without slides комплексия без направляющих	800	760-768			
W-WSPD80-GX-60	na prowadnicy kulkowej H45 on ball bearing slide H45 на шариковой направляющей H45					
W-WSPD80-VE-60	na prowadnicy kulkowej H45 z funkcją cichego zamknięcia on ball bearing slide H45 with soft closing на шариковой направляющей H45 с доводчиком					
W-WSPD90-BP-60	komplet bez prowadnic set without slides комплексия без направляющих	900	860-868			
W-WSPD90-GX-60	na prowadnicy kulkowej H45 on ball bearing slide H45 на шариковой направляющей H45					
W-WSPD90-VE-60	na prowadnicy kulkowej H45 z funkcją cichego zamknięcia on ball bearing slide H45 with soft closing на шариковой направляющей H45 с доводчиком					





 A
min/max

W-WSPD60-BP-10	komplet bez prowadnic set without slides комплексция без направляющих	600		560 - 568	biały white белый	stal, tworzywo steel, plastic сталь, пластмасса
W-WSPD60-GX-10	na prowadnicy kulkowej H45 on ball bearing slide H45 на шариковой направляющей H45					
W-WSPD60-VE-10	na prowadnicy kulkowej H45 z funkcją cichego zamknięcia on ball bearing slide H45 with soft closing на шариковой направляющей H45 с доводчиком					
W-WSPD70-BP-10	komplet bez prowadnic set without slides комплексция без направляющих	700		660 - 668		
W-WSPD70-GX-10	na prowadnicy kulkowej H45 on ball bearing slide H45 на шариковой направляющей H45					
W-WSPD70-VE-60	na prowadnicy kulkowej H45 z funkcją cichego zamknięcia on ball bearing slide H45 with soft closing на шариковой направляющей H45 с доводчиком					
W-WSPD80-BP-10	komplet bez prowadnic set without slides комплексция без направляющих	800	pełny full полное	760-768		
W-WSPD80-GX-10	na prowadnicy kulkowej H45 on ball bearing slide H45 на шариковой направляющей H45					
W-WSPD80-VE-10	na prowadnicy kulkowej H45 z funkcją cichego zamknięcia on ball bearing slide H45 with soft closing на шариковой направляющей H45 с доводчиком					
W-WSPD90-BP-10	komplet bez prowadnic set without slides комплексция без направляющих	900		860-868		
W-WSPD90-GX-10	na prowadnicy kulkowej H45 on ball bearing slide H45 на шариковой направляющей H45					
W-WSPD90-VE-10	na prowadnicy kulkowej H45 z funkcją cichego zamknięcia on ball bearing slide H45 with soft closing на шариковой направляющей H45 с доводчиком					

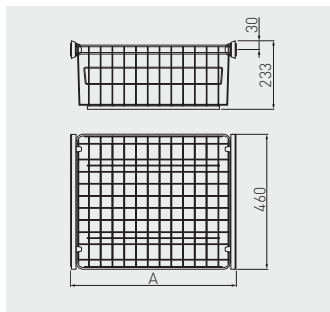

Kosz SMART na bieliznę SMART wardrobe basket Корзина для шкафа SMART

 A
min/max

W-WK060-BP-60	komplet bez prowadnic set without slides комплектция без направляющих	600	pełny full полное	szary gray серый	stal, tworzywo steel, plastic сталь, пластмасса	
W-WK060-GX-60	na prowadnicy kulkowej H45 on ball bearing slide H45 на шариковой направляющей H45					560-568
W-WK060-VE-60	na prowadnicy kulkowej H45 z funkcją cichego zamknięcia on ball bearing slide H45 with soft closing на шариковой направляющей H45 с доводчиком					
W-WK070-BP-60	komplet bez prowadnic set without slides комплектция без направляющих	700	pełny full полное	szary gray серый	stal, tworzywo steel, plastic сталь, пластмасса	
W-WK070-GX-60	na prowadnicy kulkowej H45 on ball bearing slide H45 на шариковой направляющей H45					660-668
W-WK070-VE-60	na prowadnicy kulkowej H45 z funkcją cichego zamknięcia on ball bearing slide H45 with soft closing на шариковой направляющей H45 с доводчиком					
W-WK080-BP-60	komplet bez prowadnic set without slides комплектция без направляющих	800	pełny full полное	szary gray серый	stal, tworzywo steel, plastic сталь, пластмасса	
W-WK080-GX-60	na prowadnicy kulkowej H45 on ball bearing slide H45 на шариковой направляющей H45					760-768
W-WK080-VE-60	na prowadnicy kulkowej H45 z funkcją cichego zamknięcia on ball bearing slide H45 with soft closing на шариковой направляющей H45 с доводчиком					
W-WK090-BP-60	komplet bez prowadnic set without slides комплектция без направляющих	900	pełny full полное	szary gray серый	stal, tworzywo steel, plastic сталь, пластмасса	
W-WK090-GX-60	na prowadnicy kulkowej H45 on ball bearing slide H45 на шариковой направляющей H45					860-868
W-WK090-VE-60	na prowadnicy kulkowej H45 z funkcją cichego zamknięcia on ball bearing slide H45 with soft closing на шариковой направляющей H45 с доводчиком					





 A
min/max

W-WK060-BP-10	komplet bez prowadnic set without slides комплексция без направляющих	600	560-568	pełny full полное	biały white белый	stal, tworzywo steel, plastic сталь, пластмасса
W-WK060-GX-10	na prowadnicy kulkowej H45 on ball bearing slide H45 на шариковой направляющей H45					
W-WK060-VE-10	na prowadnicy kulkowej H45 z funkcją cichego zamknięcia on ball bearing slide H45 with soft closing на шариковой направляющей H45 с доводчиком					
W-WK070-BP-10	komplet bez prowadnic set without slides комплексция без направляющих	700	660-668			
W-WK070-GX-10	na prowadnicy kulkowej H45 on ball bearing slide H45 на шариковой направляющей H45					
W-WK070-VE-10	na prowadnicy kulkowej H45 z funkcją cichego zamknięcia on ball bearing slide H45 with soft closing на шариковой направляющей H45 с доводчиком					
W-WK080-BP-10	komplet bez prowadnic set without slides комплексция без направляющих	800	760-768			
W-WK080-GX-10	na prowadnicy kulkowej H45 on ball bearing slide H45 на шариковой направляющей H45					
W-WK080-VE-10	na prowadnicy kulkowej H45 z funkcją cichego zamknięcia on ball bearing slide H45 with soft closing на шариковой направляющей H45 с доводчиком					
W-WK090-BP-10	komplet bez prowadnic set without slides комплексция без направляющих	900	860-868			
W-WK090-GX-10	na prowadnicy kulkowej H45 on ball bearing slide H45 на шариковой направляющей H45					
W-WK090-VE-10	na prowadnicy kulkowej H45 z funkcją cichego zamknięcia on ball bearing slide H45 with soft closing на шариковой направляющей H45 с доводчиком					

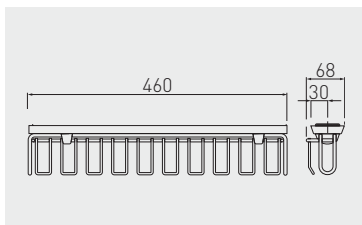

Wieszak SMART na paski i krawaty
 SMART belt and tie rack
 Вешалка для ремней и галстуков SMART



W-WKRP-BP-60	komplet bez prowadnic set without slides комплексия без направляющих	pełny full полное	szary gray серый	stal, tworzywo steel, plastic сталь, пластмасса
W-WKRP-GX-60	na prowadnicy kulkowej H45 on ball bearing slide H45 на шариковой направляющей H45			
W-WKRP-VE-60	na prowadnicy kulkowej H45 z funkcją cichego zamknięcia on ball bearing slide H45 with soft closing на шариковой направляющей H45 с доводчиком			
W-WKRP-BP-10	komplet bez prowadnic set without slides комплексия без направляющих	biały white белый		
W-WKRP-GX-10	na prowadnicy kulkowej H45 on ball bearing slide H45 на шариковой направляющей H45			
W-WKRP-VE-10	na prowadnicy kulkowej H45 z funkcją cichego zamknięcia on ball bearing slide H45 with soft closing на шариковой направляющей H45 с доводчиком			



Kosz dwupoziomowy na obuwie
Two tier pull out shoes rack
Двухуровневая корзина для обуви

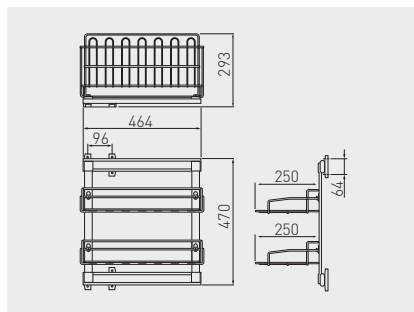

PP-20BUW0-05	lewy / prawy left / right левый / правый	niepełny partial неполное	chrom, aluminium, czarny chrome, aluminium, black хром, алюминий, чёрный	stal, aluminium, tworzywo steel, aluminium, plastic сталь, алюминий, пластмасса
--------------	--	---------------------------------	--	---



Kosz dwupoziomowy
Two tier wardrobe basket
Двухуровневая корзина

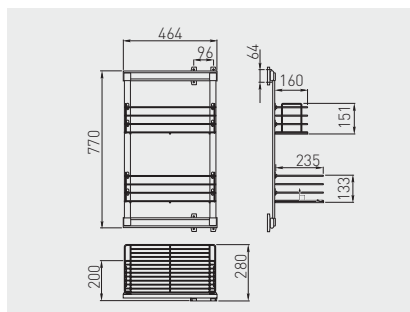

WW-2KOSZ0-05	lewy / prawy left / right левый / правый	niepełny partial неполное	chrom, aluminium, czarny chrome, aluminium, black хром, алюминий, чёрный	stal, aluminium, tworzywo steel, aluminium, plastic сталь, алюминий, пластмасса
--------------	--	---------------------------------	--	---



Szuflada na obuwie
Pull out shoes rack
Полка для обуви

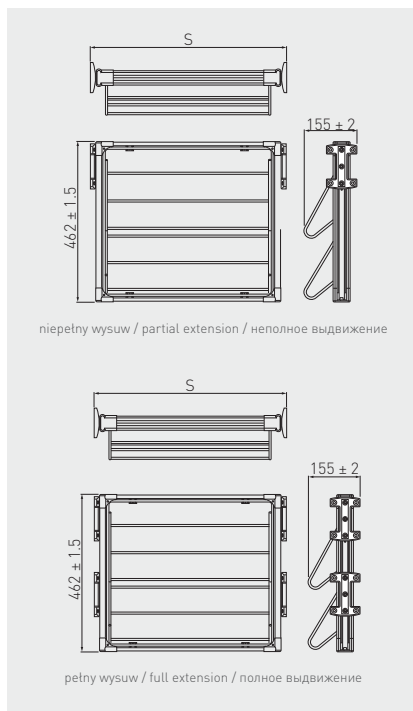

niepełny wysuw / partial extension / неполное выдвижение

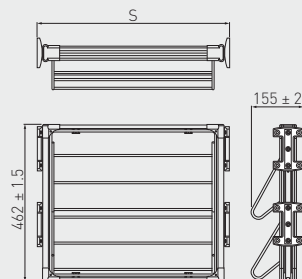

pełny wysuw / full extension / полное выдвижение

			S min/max			
PP-OB UW60-05			560-581	chrom chrome хром	chrom, aluminium, czarny chrome, aluminium, black хром, алюминий, чёрный	stal, aluminium, tworzywo steel, aluminium, plastic сталь, алюминий, пластмасса
PP-OB UW70-05	niepełny partial неполное		660-681			
PP-OB UW80-05			760-781			
PP-OB UW90-05			860-861			
PP-OB UW60-PW	pełny full полное		564-585			
PP-OB UW70-PW			664-685			
PP-OB UW80-PW			764-785			
PP-OB UW90-PW			864-885			



Kosz do szaf
Wardrobe basket
Корзина для шкафа

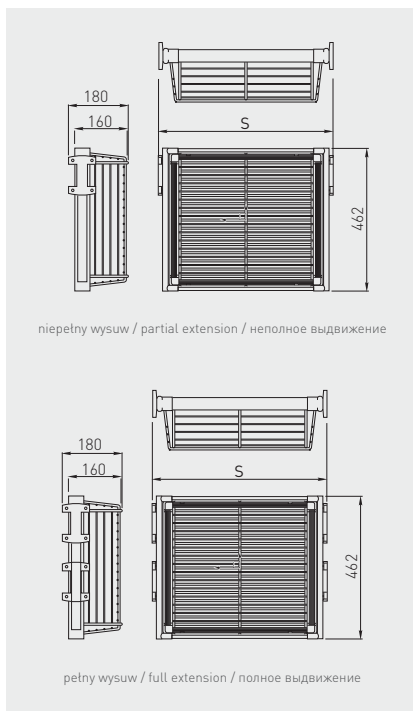

		S min/max		
WW-KOSZ60-05	niepełny partial неполное	560-581	chrom, aluminium, czarny chrome, aluminium, black хром, алюминий, чёрный	stal, aluminium, tworzywo steel, aluminium, plastic сталь, алюминий, пластмасса
WW-KOSZ70-05		660-681		
WW-KOSZ80-05		760-781		
WW-KOSZ90-05		860-881		
WW-KOSZ60-PW	pełny full полное	564-585		
WW-KOSZ70-PW		664-685		
WW-KOSZ80-PW		764-785		
WW-KOSZ90-PW		864-885		



Wieszak na spodnie
Wardrobe trouser rack
Вешалка для брюк

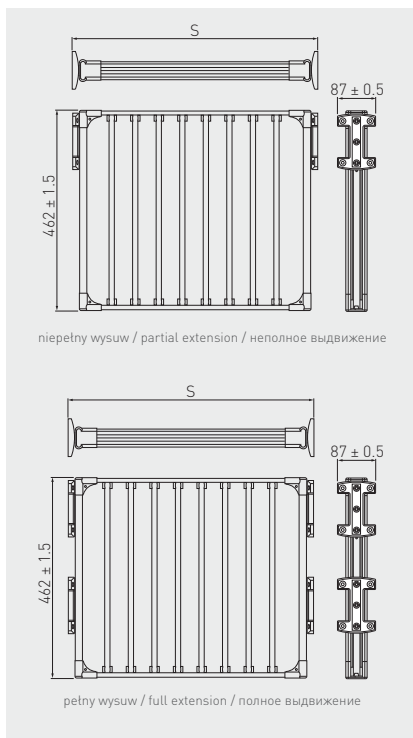







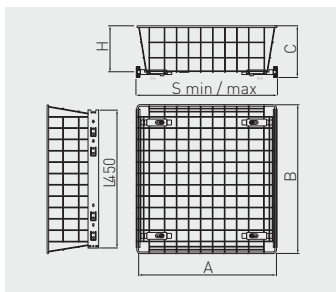







		S min/max		
WW-WSP060-05	niepełny partial неполное	560-581	chrom, aluminium, czarny chrome, aluminium, black хром, алюминий, чёрный	stal, aluminium, tworzywo steel, aluminium, plastic сталь, алюминий, пластмасса
WW-WSP070-05		660-681		
WW-WSP080-05		760-781		
WW-WSP090-05	860-881			
WW-WSP060-PW	pełny full полное	564-585		
WW-WSP070-PW		664-685		
WW-WSP080-PW		764-785		
WW-WSP090-PW		864-885		



Kosz na prowadnicy kulkowej H35*
 Wardrobe basket on a H35 ball bearing slide*
 Корзина на шариковых направляющих H35*









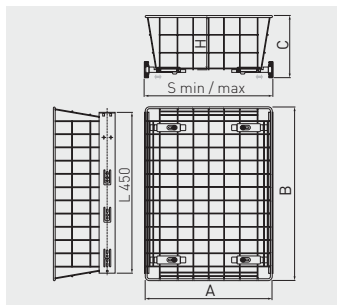



		 mm	 mm	 mm	 mm	 mm	 min/max						
KO-SRH35100-30-10		300	100	255	485	68	260-285			osynek galvanized гальваника	biały white белый	stal steel сталь	
KO-SRH35100-40-10		400	100	355	485	68	360-385						
KO-SRH35100-50-10		500	100	455	485	68	460-485						
KO-SRH35100-60-10		600	100	555	485	68	560-585						
KO-SRH35150-30-10		300	150	255	485	118	260-285						
KO-SRH35150-40-10		400	150	355	485	118	360-385						
KO-SRH35150-50-10		500	150	455	485	118	460-485						
KO-SRH35150-60-10		600	150	555	485	118	560-585						
KO-SRH35200-30-10		300	200	255	485	168	260-285						
KO-SRH35200-40-10		400	200	355	485	168	360-385						
KO-SRH35200-50-10		500	200	455	485	168	460-485						
KO-SRH35200-60-10		600	200	555	485	168	560-585						
KO-SRH35100-30-OC		300	100	255	485	68	260-285					srebrny silver серебристый	stal steel сталь
KO-SRH35100-40-OC		400	100	355	485	68	360-385						
KO-SRH35100-50-OC		500	100	455	485	68	460-485						
KO-SRH35100-60-OC		600	100	555	485	68	560-585						
KO-SRH35150-30-OC		300	150	255	485	118	260-285						
KO-SRH35150-40-OC		400	150	355	485	118	360-385						
KO-SRH35150-50-OC		500	150	455	485	118	460-485						
KO-SRH35150-60-OC		600	150	555	485	118	560-585						
KO-SRH35200-30-OC		300	200	255	485	168	260-285						
KO-SRH35200-40-OC		400	200	355	485	168	360-385						
KO-SRH35200-50-OC		500	200	455	485	168	460-485						
KO-SRH35200-60-OC		600	200	555	485	168	560-585						



Kosz na prowadnicy kulkowej H45 ze spowalniczem
 Wardrobe basket on a H45 adjustable ball bearing slide
 Корзина на шариковых направляющих H45









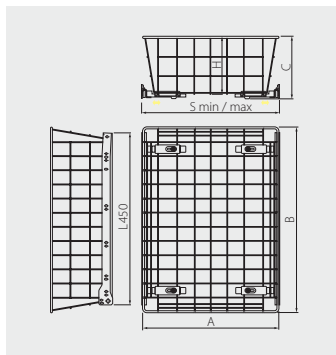



		 mm	 mm	 mm	 mm	 mm	 min/max			
KO-SRH4550-30-10		300	50	255	485	73	260-285	osynek galvanized гальваника	biały white белый	stal steel сталь
KO-SRH4550-40-10		400	50	355	485	73	360-385			
KO-SRH4550-50-10		500	50	455	485	73	460-485			
KO-SRH4550-60-10		600	50	555	485	73	560-585			
KO-SRH45100-30-10		300	100	255	485	123	260-285			
KO-SRH45100-40-10		400	100	355	485	123	360-385			
KO-SRH45100-50-10		500	100	455	485	123	460-485			
KO-SRH45100-60-10		600	100	555	485	123	560-585			
KO-SRH45150-30-10		300	150	255	485	173	260-285			
KO-SRH45150-40-10		400	150	355	485	173	360-385			
KO-SRH45150-50-10		500	150	455	485	173	460-485			
KO-SRH45150-60-10		600	150	555	485	173	560-585			
KO-SRH45200-30-10		300	200	255	485	223	260-285			
KO-SRH45200-40-10		400	200	355	485	223	360-385			
KO-SRH45200-50-10		500	200	455	485	223	460-485			
KO-SRH45200-60-10		600	200	555	485	223	560-585			
KO-SRH4550-30-OC		300	50	255	485	73	260-285			
KO-SRH4550-40-OC		400	50	355	485	73	360-385			
KO-SRH4550-50-OC		500	50	455	485	73	460-485			
KO-SRH4550-60-OC		600	50	555	485	73	560-585			
KO-SRH45100-30-OC		300	100	255	485	123	260-285			
KO-SRH45100-40-OC		400	100	355	485	123	360-385			
KO-SRH45100-50-OC		500	100	455	485	123	460-485			
KO-SRH45100-60-OC		600	100	555	485	123	560-585			
KO-SRH45150-30-OC		300	150	255	485	173	260-285			
KO-SRH45150-40-OC		400	150	355	485	173	360-385			
KO-SRH45150-50-OC		500	150	455	485	173	460-485			
KO-SRH45150-60-OC		600	150	555	485	173	560-585			
KO-SRH45200-30-OC		300	200	255	485	223	260-285			
KO-SRH45200-40-OC		400	200	355	485	223	360-385			
KO-SRH45200-50-OC		500	200	455	485	223	460-485			
KO-SRH45200-60-OC		600	200	555	485	223	560-585			



Kosz na prowadnicy rolkowej L = 450*
 Wardrobe basket on a L = 450 slide*
 Корзина на роликовых направляющих L = 450*



		 mm	 H mm	 A mm	 B mm	 C mm	 S min/max			
KO-SRPR100-30-10		300	100	255	485	123	260-285	ocynk galvanized гальваника	biały white белый	stal tworzywo steel plastic сталь пластмасса
KO-SRPR100-40-10		400	100	355	485	123	360-385			
KO-SRPR100-50-10		500	100	455	485	123	460-485			
KO-SRPR100-60-10		600	100	555	485	123	560-585			
KO-SRPR150-30-10		300	150	255	485	173	260-285			
KO-SRPR150-40-10		400	150	355	485	173	360-385			
KO-SRPR150-50-10		500	150	455	485	173	460-485			
KO-SRPR150-60-10		600	150	555	485	173	560-585			
KO-SRPR200-30-10		300	200	255	485	223	260-285			
KO-SRPR200-40-10		400	200	355	485	223	360-385			
KO-SRPR200-50-10		500	200	455	485	223	460-485			
KO-SRPR200-60-10		600	200	555	485	223	560-585			
KO-SRPR150-30-OC		300	150	255	485	123	260-285		srebrny silver серебристый	
KO-SRPR100-40-OC		400	100	355	485	123	360-385			
KO-SRPR100-30-OC		300	100	455	485	123	460-485			
KO-SRPR100-50-OC		500	100	555	485	123	560-585			
KO-SRPR100-60-OC		600	100	255	485	173	260-285			
KO-SRPR150-40-OC		400	150	355	485	173	360-385			
KO-SRPR150-50-OC		500	150	455	485	173	460-485			
KO-SRPR150-60-OC		600	150	555	485	173	560-585			
KO-SRPR200-30-OC		300	200	255	485	223	260-285			
KO-SRPR200-40-OC		400	200	355	485	223	360-385			
KO-SRPR200-50-OC		500	200	455	485	223	460-485			
KO-SRPR200-60-OC		600	200	555	485	223	560-585			



Wieszak na spodnie podwieszany
Wardrobe pull-out trouser rack
Вешалка для брюк подвесная

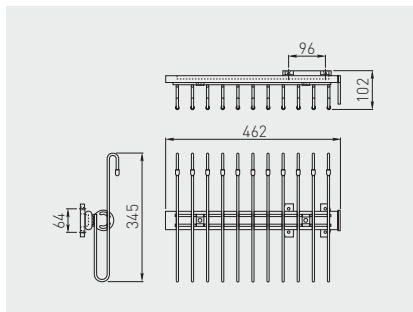

WW-WSP00-01	niepety partial неполное	chrom, aluminium, czarny chrome, aluminium, black хром, алюминий, чёрный	stal, aluminium, tworzywo steel, aluminium, plastic сталь, алюминий, пластмасса



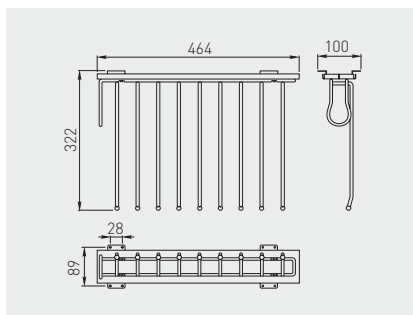

Wieszak WS na spodnie
Trousler rack WS
Вешалка WS для брюк

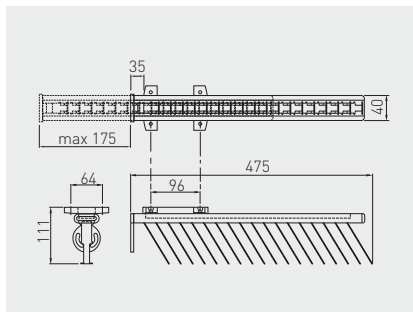

WW-WSP000-01	prawy right правый	niecety partial неполное	chrom, aluminium, czarny chrome, aluminium, black хром, алюминий, чёрный	stal, aluminium, tworzywo steel, aluminium, plastic сталь, алюминий, пластмасса
WW-WSL000-01	lewy left левый			

Wieszak KRA na krawaty
 Tie hanger KRA
 Подвеска для галстуков KRA



				
WW-KRAW00-20	lewy / prawy left / right левый / правый	niepełny partial неполное	chrom, aluminium, czarny chrome, aluminium, black хром, алюминий, чёрный	stal, aluminium, tworzywo steel, aluminium, plastic сталь, алюминий, пластмасса

Wieszak KJ na krawaty
 Tie hanger KJ
 Подвеска для галстуков KJ

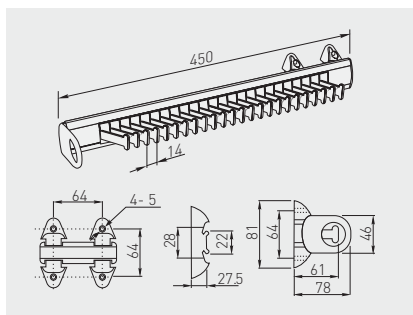

				
WW-KJ0101-01	lewy / prawy left / right левый / правый	niepełny partial неполное	aluminium, czarny aluminium, black алюминий, чёрный	stal, aluminium, tworzywo steel, aluminium, plastic сталь, алюминий, пластмасса

Wieszak KJ na paski
Belt rack KJ
Вешалка KJ для ремней

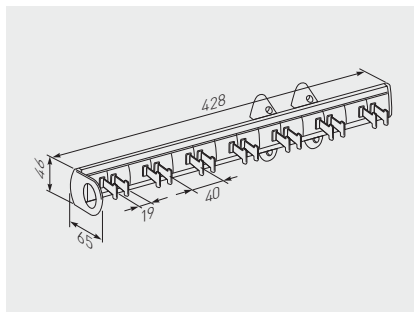



				
WW-KJ0201-01	lewy / prawy left / right левый / правый	niepetyny partial неполное	aluminium, czarny aluminium, black алюминий, чёрный	stal, aluminium, tworzywo steel, aluminium, plastic сталь, алюминий, пластмасса

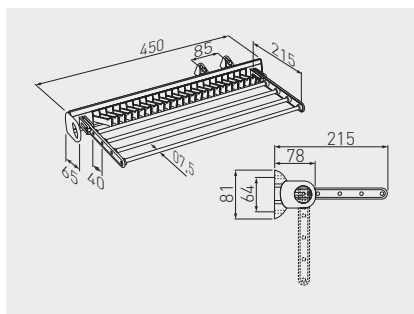

Wieszak J03 na krawaty i spodnie
Trouser and tie hanger J03
Вешалка J03 для брюк и галстуков



				
WW-K0AJ03-01	lewy / prawy left / right левый / правый	niepetyny partial неполное	chrom, aluminium, czarny chrome + aluminium, black хром, алюминий, чёрный	stal, aluminium, tworzywo steel, aluminium, plastic сталь, алюминий, пластмасса



Wieszak na spodnie składany
 Foldable trouser rack
 Вешалка для брюк, складная

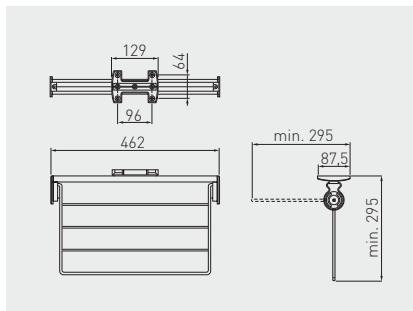

WW-SPODN0-05	lewy / prawy left / right левый / правый	niepełny partial неполное	chrom, aluminium, czarny chrome, aluminium, black хром, алюминий, чёрный	stal, aluminium, tworzywo steel, aluminium, plastic сталь, алюминий, пластмасса



Wieszak J03 na spodnie
 Trouser rack J03
 Вешалка J03 для брюк

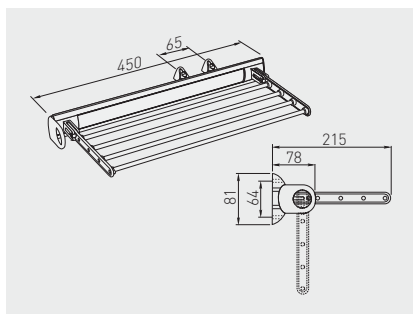

WW-K00J03-01	lewy / prawy left / right левый / правый	niepełny partial неполное	aluminium, czarny aluminium, black алюминий, чёрный	aluminium, tworzywo aluminium, plastic алюминий, пластмасса



Wieszak J04 na krawaty i spodnie
 Trouser and tie rack J04
 Вешалка J04 для брюк и галстуков

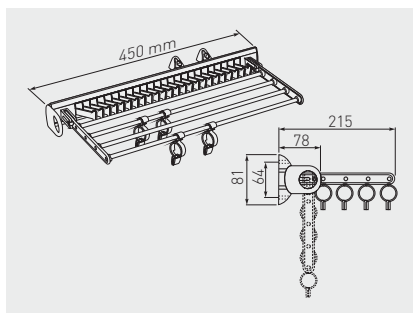

WW-K0AJ04-01	lewy / prawy left / right левый / правый	niepełny partial неполное	aluminium, czarny aluminium, black алюминий, чёрный	stal, aluminium, tworzywo steel, aluminium, plastic сталь, алюминий, пластмасса



Wieszak WU na ubrania
 Clothes hanger WU
 Вешалка WU для одежды

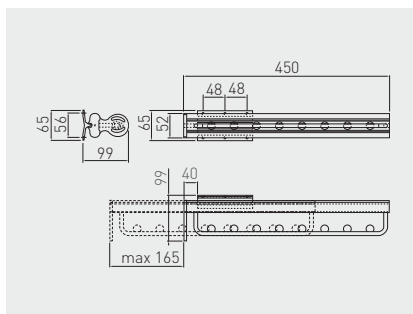

WW-WUBR00-01	niepełny partial неполное	chrom, aluminium, czarny chrome, aluminium, black хром, алюминий, чёрный	stal, aluminium, tworzywo steel, aluminium, plastic сталь, алюминий, пластмасса



Wieszak K0 na paski
Hanger for belts K0
Вешалка K0 для ремней

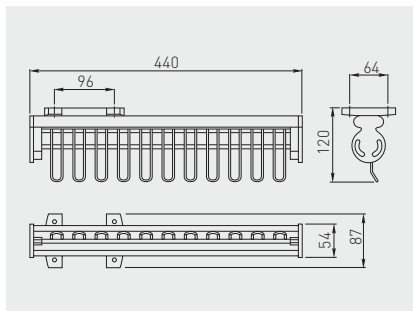

WW-PASEK0-05	lewy / prawy left / right левый / правый	niepełny partial неполное	chrom, aluminium, czarny chrome, aluminium, black хром, алюминий, чёрный	stal, aluminium, tworzywo steel, aluminium, plastic сталь, алюминий, пластмасса



Wieszak SE
Hanger SE
Вешалка SE

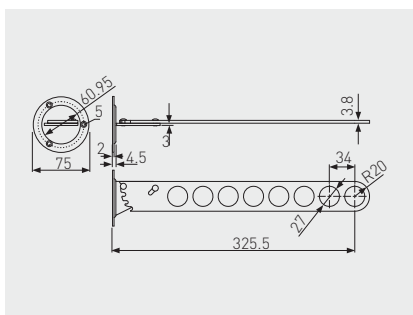





WW-SE0102-01	chrom chrome хром	stal steel сталь

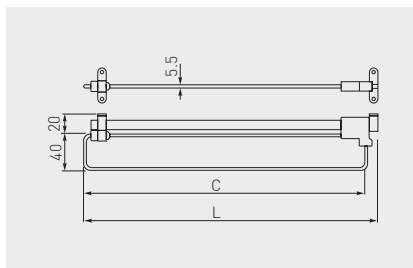







Wieszak WSL
Hanger WSL
Вешалка WSL

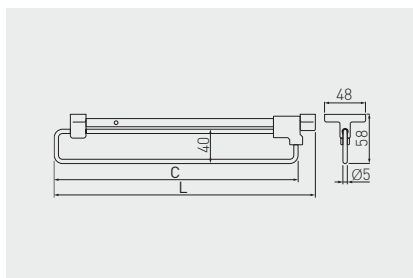

		 C mm	 L mm		
WW-WSL250-01		235	250	chrom chrome хром	stal steel сталь
WW-WSL300-01		285	300		
WW-WSL350-01		335	350		
WW-WSL400-01		385	400		
WW-WSL450-01		435	450		
WW-WSL500-01		485	500		

Wieszak WSL-B wysuwny
Retractable hanger WSL-B
Выдвижная подвеска WSL-B





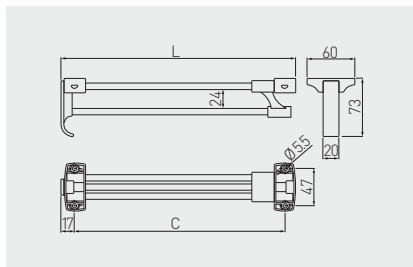

		 C mm	 L mm		
WW-WSL250-01B		235	250	chrom, czarny chrome, black хром, чёрный	stal, tworzywo steel, plastic сталь, пластмасса
WW-WSL300-01B		285	300		
WW-WSL350-01B		335	350		
WW-WSL400-01B		385	400		
WW-WSL450-01B		435	450		
WW-WSL500-01B		485	500		

Wieszak WSD wysuwny
Retractable hanger WSD
Выдвижная подвеска WSD





NEW

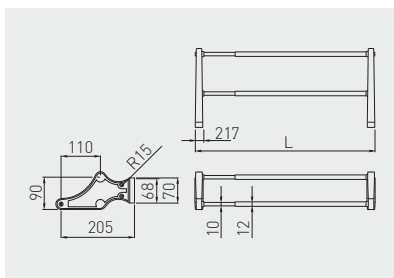

	 C mm	 L mm		
WW-WSD250-01B	220	252	chrom, czarny chrome, black хром, чёрный	stal, tworzywo steel, plastic сталь, пластмасса
WW-WSD300-01B	270	302		
WW-WSD350-01B	320	352		
WW-WSD400-01B	370	402		
WW-WSD450-01B	420	452		
WW-WSD500-01B	470	502		

Półka na obuwie
Shoe rack
Полка для обуви



	 L mm		
PP-P04570-20	415 - 700	chrom, aluminium, czarny chrome, aluminium, black хром, алюминий, чёрный	stal, aluminium, tworzywo steel, aluminium, plastic сталь, алюминий, пластмасса
PP-P80110-20	715 - 1100	chrom, czarny chrome, black хром, чёрный	stal, tworzywo steel, plastic сталь, пластмасса



Zawias do półki na obuwie Hinge for shoe rack Крепление для полки под обувь

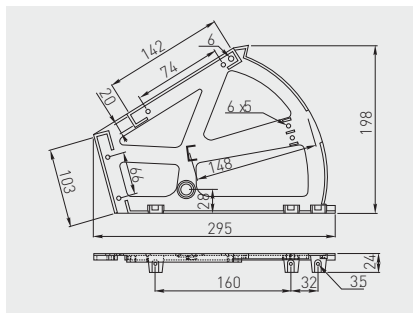

Zastosowanie dla płyty 12 mm
For 12 mm board
Крепление к плите 12 мм



WW-ZWBUT2-10	biały / white / белый	tworzywo plastic пластмасса
WW-ZWBUT2-20	czarny / black / чёрный	



Pantograf z podnośnikiem gazowym Pull-down wardrobe rail - gas Пантограф с газовым подъемником

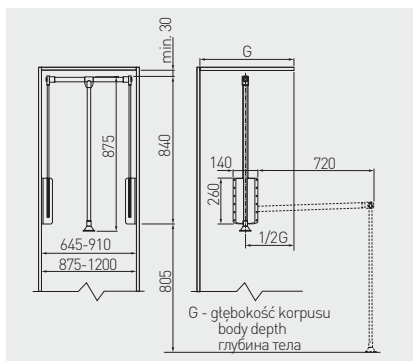





PA-GA4560-10	545 - 700	12	biały / white / белый	stal, tworzywo steel, plastic сталь, пластмасса
PG-GA6083-10	645 - 910			
PA-GA4560-20	545 - 700		czarny / black / чёрный	
PG-GA6083-20	645 - 910			
PG-GA8311520	875 - 1200			

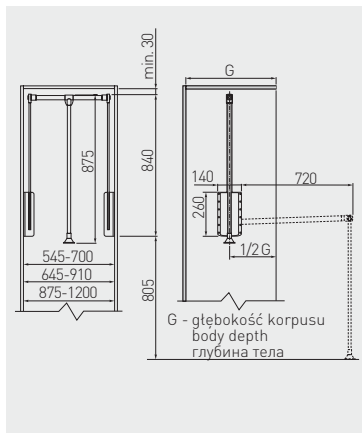

Pantograf z podnośnikiem olejowym
 Pull-down wardrobe rail – oil
 Пантограф с масляным подъемником



	 mm	 kg			
PG-AL4560-20	545 – 700	8	aluminium / aluminium / алюминий	aluminium, tworzywo aluminium, plastic алюминий, пластмасса	
PG-AL6083-20	645 – 910				
PG-AL8311520	875 – 1200				
PG-ST4560-10	545 – 700			biały / white / белый	stal, tworzywo steel, plastic сталь, пластмасса
PG-ST4560-20				czarny / black / чёрный	
PG-ST6083-10	645 – 910			biały / white / белый	
PG-ST6083-20				czarny / black / чёрный	
PG-ST83115-10	875 – 1200			biały / white / белый	
PG-ST8311520		czarny / black / чёрный			



Segregator PRACTI ECO 400
 Trash bin PRACTI ECO 400
 Серператор PRACTI ECO 400

NEW

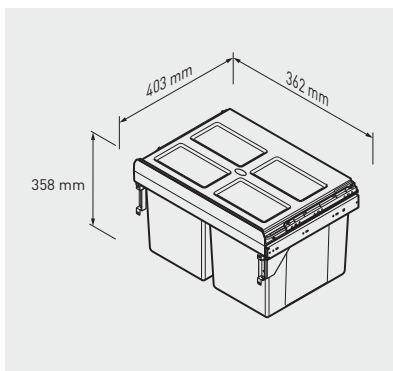

PB-S400MF-2X16-60

400

2 x 16 L

szary / gray / серый

tworzywo / plastic / пластмасса



Segregator PRACTI ECO 300
 Trash bin PRACTI ECO 300
 Сеператор PRACTI ECO 300



PB-45-0010X3



PB-45-002010

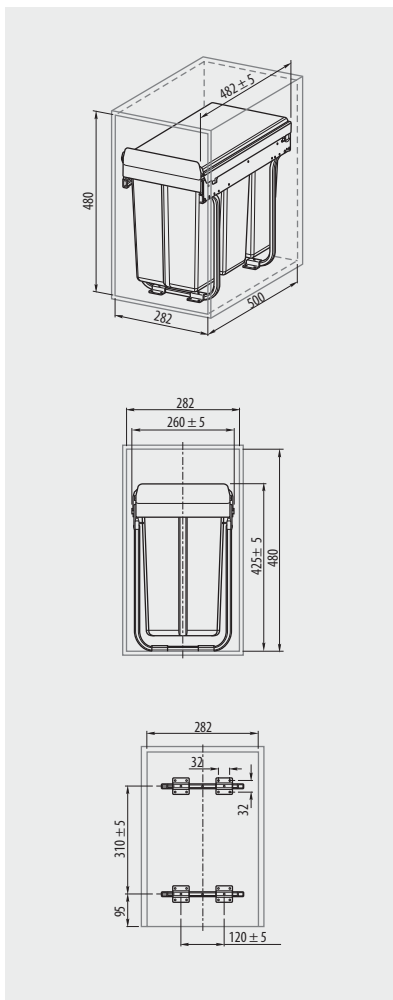

Na prowadnicy kulkowej H45 z cichym domykiem
 On ball bearing slide H45 with soft closing
 На шариковой направляющей H45 с доводчиком

		 mm			
PB-45-0010X3		300	3 x 10 L	szary / gray / серый	tworzywo / plastic / пластмасса
PB-45-002010		300	10 L, 20 L		



Segregator PRACTI ECO 400
 Trash bin PRACTI ECO 400
 Сепаратор PRACTI ECO 400



PB-45-002X20



PB-45-202X10

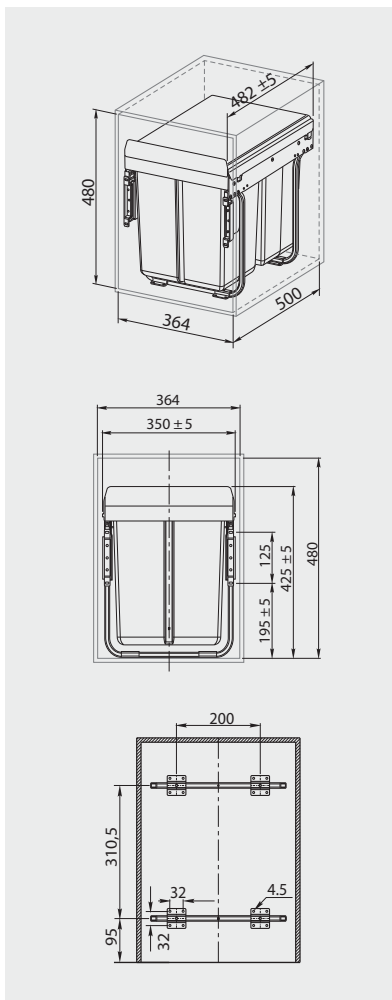

Na prowadnicy kulkowej H45 z cichym domykiem
 On ball bearing slide H45 with soft closing
 На шариковой направляющей H45 с доводчиком



PB-45-002X20	400	2 x 20 L	szary / gray / серый	tworzywo / plastic / пластмасса
PB-45-202X10	400	20 L, 2 x 10 L		



Segregator PRACTI ECO 400 z mocowaniem przednim
 Trash bin PRACTI ECO 400 with door mount bracket
 Сегрегатор PRACTI ECO 400 с передним креплением









PB-45M002S20

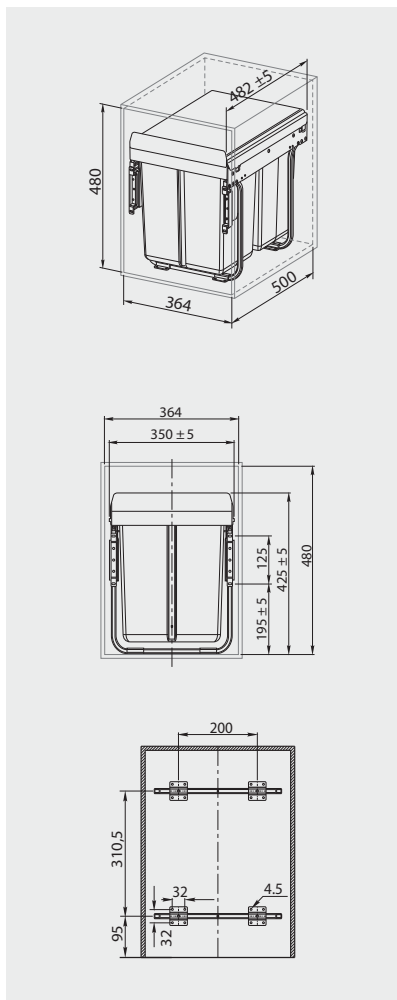

PB-45M202S10

Na prowadnicy kulkowej H45 z cichym domykiem
 On ball bearing slide H45 with soft closing
 На шариковой направляющей H45 с доводчиком



					
PB-45M002S20	400	2 x 20 L	szary / gray / серый	tworzywo / plastic / пластмасса	
PB-45M202S10		20 L, 2 x 10 L			



Segregator PRACTI ECO 450, niski
 Trash bin PRACTI ECO 450, low
 Сегрегатор PRACTI ECO 450, низкий



PB-002X15-60MB

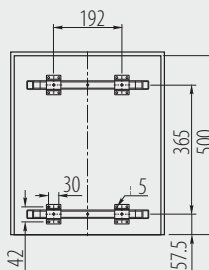
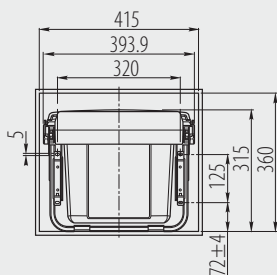
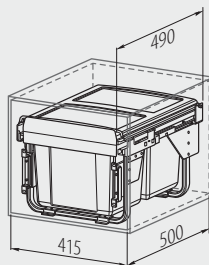

Na prowadnicy z cichym domykiem
 On slide with soft closing
 На направляющей с доводчиком



PB-002X15-60MB

450

2 x 15 L

szary / gray / серый

tworzywo / plastic / пластмасса



Segregator PRACTI ECO 450 niski z mocowaniem przednim
 Trash bin PRACTI ECO 450 low with door mount bracket
 Сегрегатор PRACTI ECO 450 низкий с передним креплением



PB-0M2S15-60MB

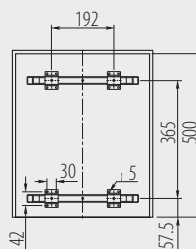
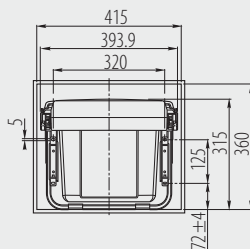
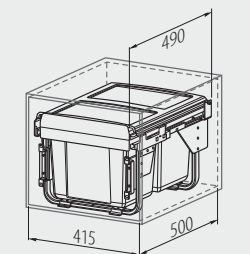

Na prowadnicy z cichym domykaniem
 On slide with soft closing
 На направляющей с доводчиком

				
PB-0M2S15-60MB	450	2 x 15 L	szary / gray / серый	tworzywo / plastic / пластмасса



Segregator PRACTI ECO 450 wysoki
 Trash bin PRACTI ECO 450 high
 Сегрегатор PRACTI ECO 450 высокий



PB-002X20-60MB



PB-0202X1060MB

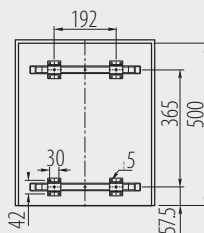
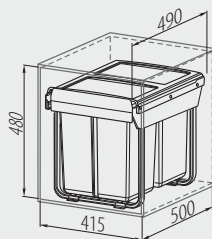
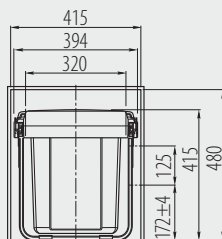

Na prowadnicy z cichym domykaniem
 On slide with soft closing
 На направляющей с доводчиком



PB-002X20-60MB	450	2 x 20 L	szary / gray / серый	tworzywo / plastic / пластмасса
PB-0202X1060MB		20 L, 2 x 10 L		



Segregator PRACTI ECO 450 wysoki z mocowaniem przednim
 Trash bin PRACTI ECO 450 high with door mount bracket
 Сегрегатор PRACTI ECO 450 высокий с передним креплением



PB-M202X1060MB



PB-0M2S20-60MB

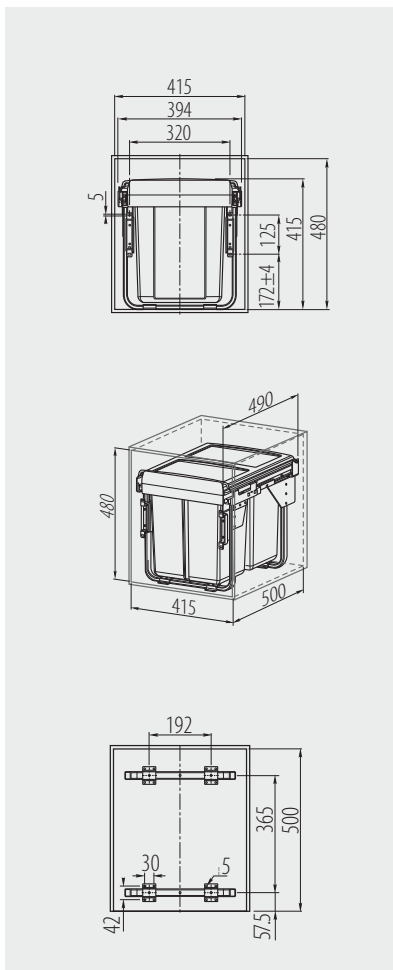

Na prowadnicy z cichym domykiem
 On slide with soft closing
 На направляющей с доводчиком



PB-M202X1060MB	450	20 L, 2 x 10 L	szary / gray / серый	tworzywo / plastic / пластмасса
PB-0M2S20-60MB		2 x 20 L		



Segregator PRACTI ECO 600
 Trash bin PRACTI ECO 600
 Серператор PRACTI ECO 600

NEW

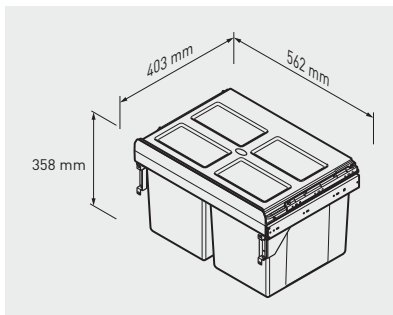

PB-S600MF-2X27-60

600

2 x 27 L

szary / gray / серый

tworzywo / plastic / пластмасса



Segregator PRACTI ECO 600 wysoki z mocowaniem przednim
 Trash bin PRACTI ECO 600 high with door mount bracket
 Сегрегатор PRACTI ECO 600 высокий с передним креплением



PB-M342X1760MB



PB-0M2X34-60MB

Na prowadnicy z cichym domykciem
 On slide with soft closing
 На направляющей с доводчиком

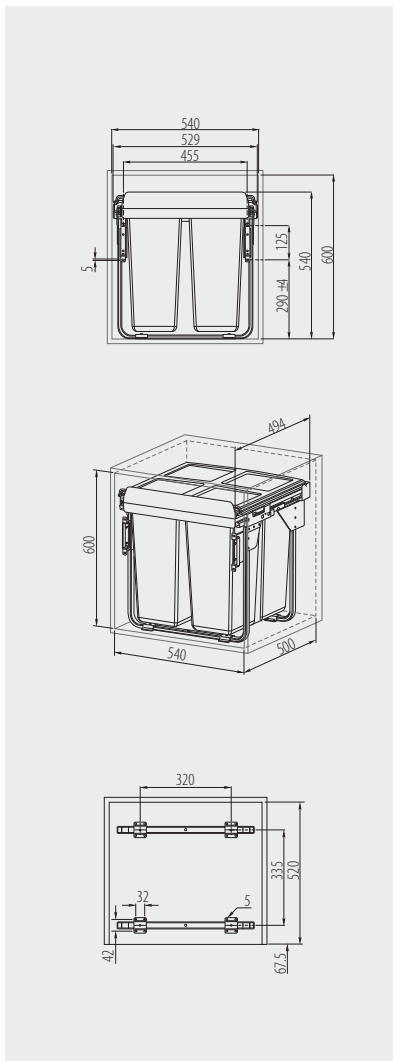

PB-M342X1760MB	600	20 L, 2 x 10 L	szary / gray / серый	tworzywo / plastic / пластмасса
PB-0M2X34-60MB		2 x 20 L		



Kosz QUADRA
Trash bin QUADRA
Мусорная корзина QUADRA

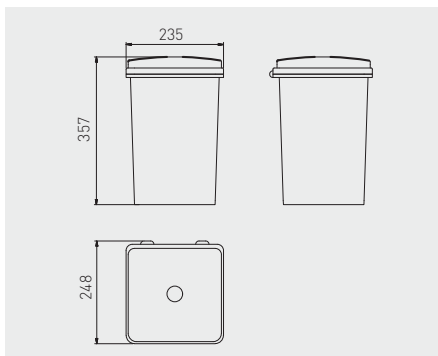

PB-91014100

13 L

szary / gray / серый

tworzywo / plastic / пластмасса



Kosz CIRCA
Trash bin CIRCA
Мусорная корзина CIRCA

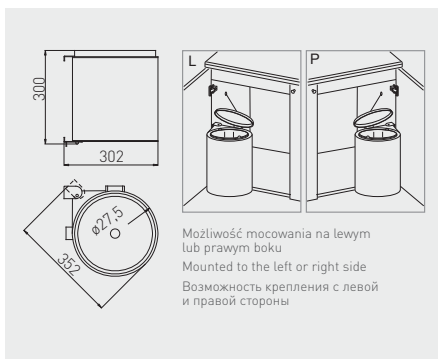

PB-91024160V

11 L

szary / gray / серый

tworzywo / plastic / пластмасса



Kosz ALTOLINO
Trash bin ALTOLINO
Мусорная корзина ALTOLINO



Możliwość mocowania na lewym lub prawym boku
Can be mounted to the left or right side
Возможность крепления с левой и правой стороны

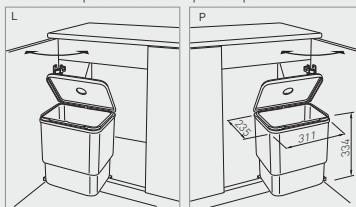

Wymiary montażowe / Mounting dimensions / Монтажные размеры

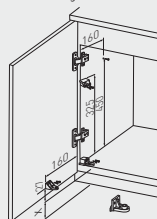

X - odległość od podłogi do górnej krawędzi wieńca
X - distance from the floor to bottom of cabinet
X - расстояние между полом и плоскостью дна шкафа

Sposób montażu / Instruction of installation / Способ монтажа

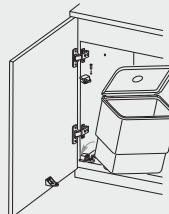

Podwieszenie pokrywki / Suspension cover / Крепление крышки

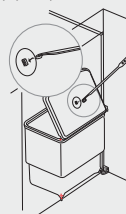

PB-90114100



11 L



szary / gray / серый



tworzywo / plastic / пластмасса



Segregator TIRA 350 plus
 Trash bin TIRA 350 plus
 Сепаратор TIRA 350 plus

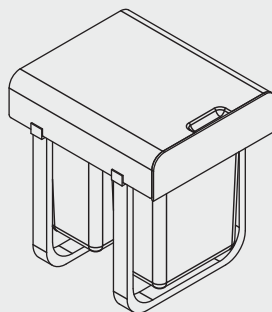
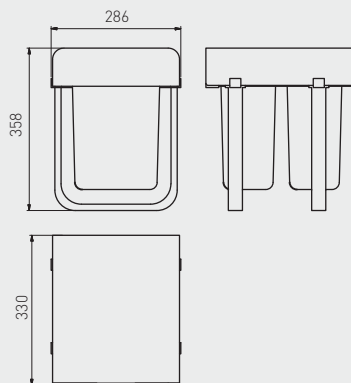

PB-90144100PCT

od 350 / from 350 / от 350

2 x 8 L

szary / gray / серый

tworzywo / plastic / пластмасса



Segregator FORZA 400 plus
 Trash bin FORZA 400 plus
 Серператор FORZA 400 plus



PB-90934100PCT



PB-90954100PCT

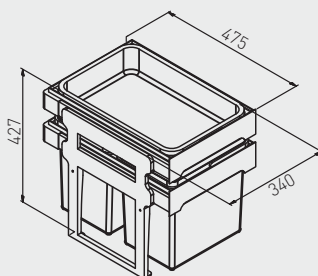
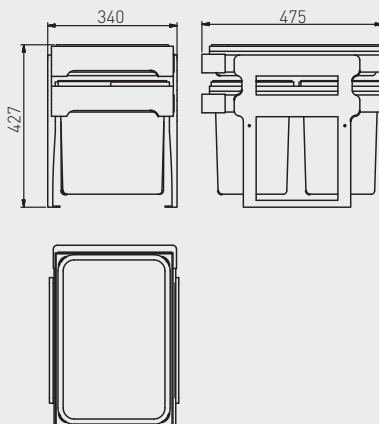

PB-90934100PCT	od 400 / from 400 / от 400	2 x 16 L	szary / gray / серый	tworzywo / plastic / пластмасса
PB-90954100PCT		1 x 16 L, 2 x 8 L		



Segregator FORZA 400 z mocowaniem przednim
 Trash bin FORZA with door mount bracket
 Сегрегатор FORZA с передним креплением



PB-91474100PCT



PB-91464100PCT

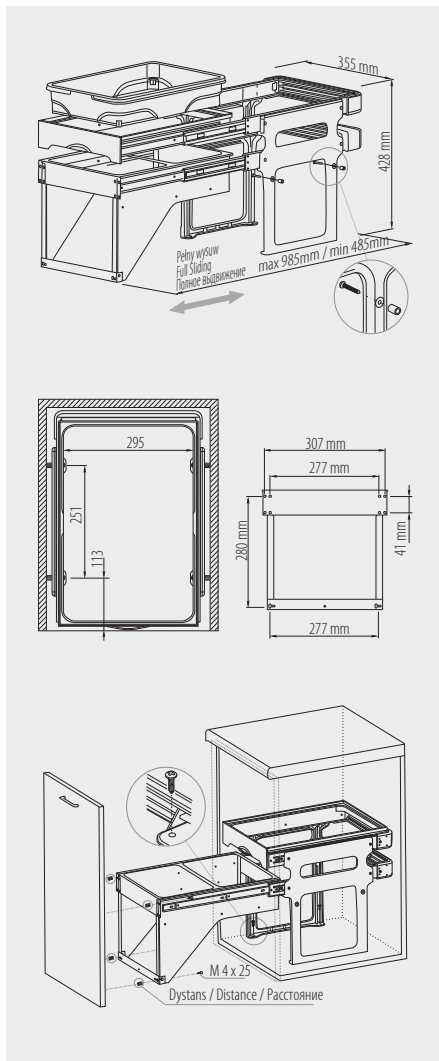

PB-91464100PCT	400	2 x 16 L	szary / gray / серый	tworzywo / plastic / пластмасса
PB-91474100PCT		1 x 16 L, 2 x 8 L		



Segregator UNITO 600
 Trash bin UNITO 600
 Сегрегатор UNITO 600





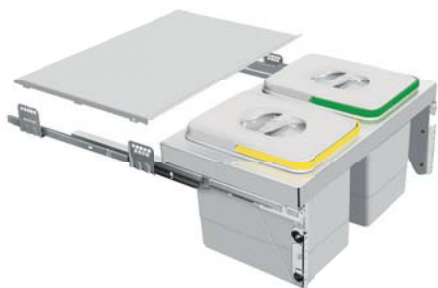

PB-91554160V

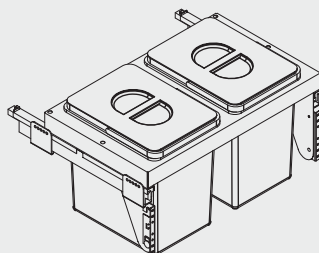
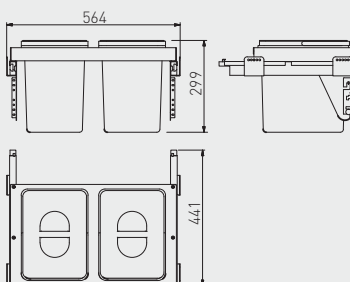

PB-91564160V



Z mocowaniem przednim. Na prowadnicach z cichym domykiem
 With door mount bracket. On ball bearing slides with soft closing
 Крепление к фасаду. Направляющие с доводчиком

				
PB-91554160V	600	2 x 15 L	szary gray серый	tworzywo plastic пластмасса
PB-91564160V		2 x 15 L, pokrywka / cover / крышка		



Segregator MULTINO Trash bin MULTINO Сегрегатор MULTINO

Przeznaczone do szuflad Modern Box
For Modern Box drawers
Только для ящиков Modern Box



PB-91114100B5



PB-91104100B5



PB-91634100B5

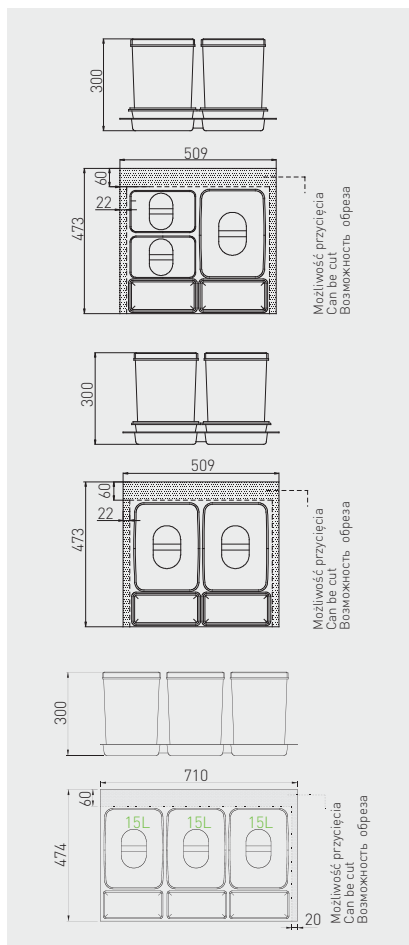

PB-91104100B5	600	2 x 15 L, 2 brytfanki / 3 tray storage spaces / наполнители	szary gray серый	tworzywo plastic пластмасса
PB-91114100B5		1 x 15 L, 2 x 7 L, 2 brytfanki / 3 tray storage spaces / наполнители		
PB-91634100B5V	800	3 x 15 L, 3 brytfanki / 3 tray storage spaces / наполнители		
PB-91644100B5V		2 x 15L, 2 x 7 L, 3 brytfanki / 3 tray storage spaces / наполнители		
PB-91164100B5	900	3 x 15 L, 3 brytfanki / 3 tray storage spaces / наполнители		
PB-91174100B5		2 x 15 L, 2 x 7, 3 brytfanki / 3 tray storage spaces / наполнители		



Segregator MULTINO Trash bin MULTINO Сегрегатор MULTINO

Przeznaczone do szuflad Modern Box
For Modern Box drawers
Только для ящиков Modern Box



PB-91644100B5



PB-91174100B5



PB-91164100B5

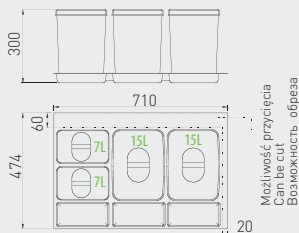

Segregator MULTINO 800 (bez przycinania) jest dopasowany do szuflady MODERN BOX NL=500 zamontowanej w korpusie LW=764*

Without modifications, the MULTINO 800 trash bin is designed to fit MODERN BOX NL=500 drawer, mounted in a cabinet LW=764*

Сегрегатор MULTINO 800 (без обреза) подходит к системе ящиков MODERN BOX NL=500, замонтированной в корпусе LW=764*

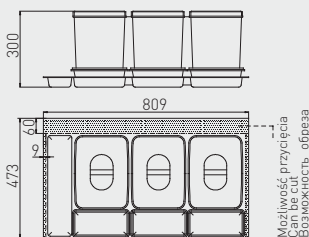
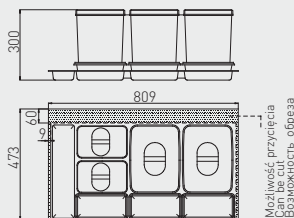

Corner standard Corner standard Выдвижная корзина, стандарт

Cichy domyk, mocowanie do frontu
Soft closing, door mounting bracket
Доводчик, крепление к фасаду

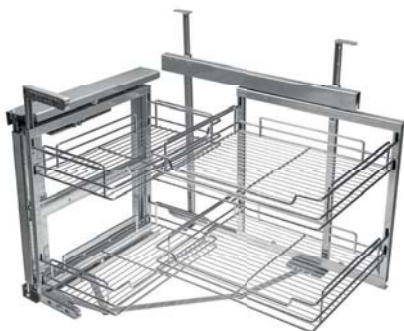

KO-UMC484SC	lewy / prawy left / right левый / правый	40	lakier, chrom lacquer, chrome лак, хром	chrom, srebrny chrome, silver хром, серебристый	stal steel сталь
-------------	--	----	---	---	------------------------

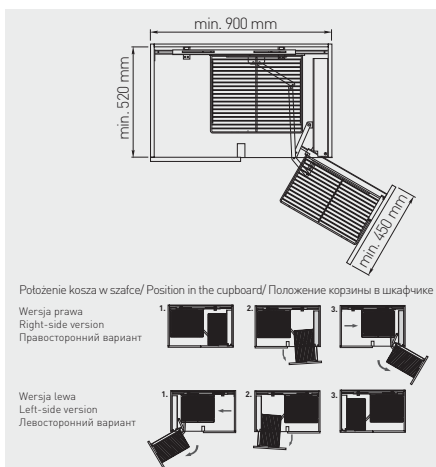

Pozycja kosza w szafce/ Position in the cupboard/ Положение корзины в шкафчике

Wersja prawa
Right-side version
Правосторонний вариант

Wersja lewa
Left-side version
Левосторонний вариант

Corner DUO Corner DUO Корзина DUO





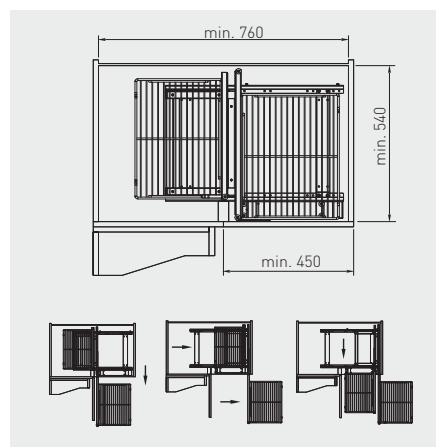

KO-UMC464SC	lewy / prawy left / right левый / правый	40	lakier, chrom lacquer, chrome лак, хром	chrom, srebrny chrome, silver хром, серебристый	stal steel сталь
-------------	--	----	---	---	------------------------

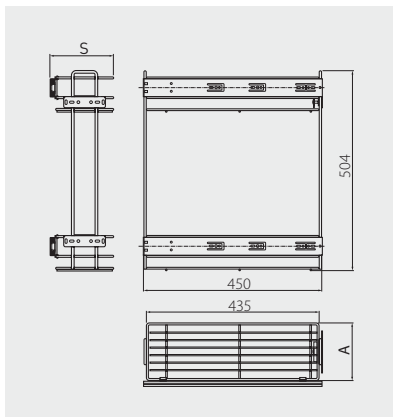

Cargo boczne na prowadnicy kulkowej H45 ze spowalniczem
 Side cargo on a H45 ball bearing slide with soft closing
 Выдвижная корзина с боковым креплением на шариковых направляющих H45 с механизмом плавного закрытия











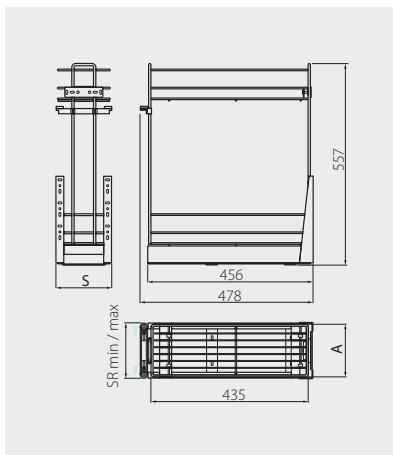

			 mm	 mm	 mm					
KO-1502BO-CR			150	95	110	osynk galvanized гальваника	chrom chrome хром	stal steel сталь		
KO-2002BO-CR			200	145	160		chrom chrome хром			
KO-3002BO-CR			300	245	260		chrom chrome хром			
KO-1502BO-10*		lewy / prawy left / right левый / правый	150	95	110		osynk galvanized гальваника		biały white белый	stal steel сталь
KO-2002BO-10*			200	145	160				biały white белый	
KO-3002BO-10*			300	245	260				biały white белый	
KO-1502BO-SR			150	95	110				srebrny silver серебристый	
KO-2002BO-SR			200	145	160				srebrny silver серебристый	
KO-3002BO-SR			300	245	260				srebrny silver серебристый	



*Produkt dostępny na indywidualne zamówienie / Available for special orders / Товар доступен под заказ

Cargo dolne na prowadnicy kulkowej H45 ze spowalniczem
 CARGO LOWER ball bearing slide H45 with soft close system
 Выдвижная корзина для нижних шкафов на шариковых направляющих H45 с механизмом плавного закрытия



		 mm	 mm	 mm				
KO-1502MD-CR		150	95	104		chrom chrome хром		
KO-2002MD-CR		200	145	154				
KO-3002MD-CR		300	245	254				
KO-4002MD-CR		400	345	345				
KO-5002MD-CR*		500	445	445				
KO-6002MD-CR*		600	545	554				
KO-1502MD-SR		150	95	104		осцил galvanized гальваника		stal steel сталь
KO-2002MD-SR		200	145	154				
KO-3002MD-SR		300	245	254				
KO-4002MD-SR		400	345	345				
KO-5002MD-SR*		500	445	445				
KO-6002MD-SR*		600	545	554				
						srebrny silver серебристый		









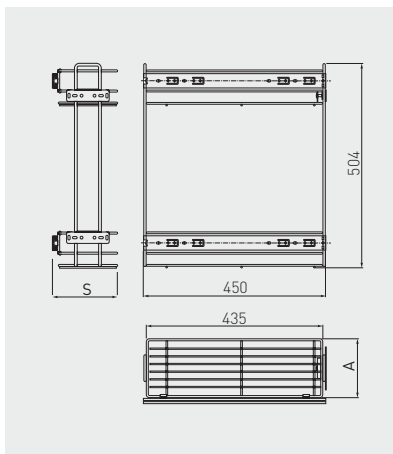

*Produkt dostępny na indywidualne zamówienie / Available for special orders / Товар доступен под заказ

Cargo boczne na prowadnicy kulkowej H35

Side cargo on a H35 ball bearing slide

Выдвижная корзина с боковым креплением на шариковых направляющих H35



		 mm	 mm	 mm				
KO-CMB150-PW-01	lewy / prawy left / right левый / правый	150	95	110	ocynk galwanizacja гальваника	chrom chrome хром	stal steel сталь	
KO-CMB200-PW-01*		200	145	160				
KO-CMB300-PW-01*		300	245	260				
KO-CMB150-PW-10		150	95	110		ocynk galwanizacja гальваника		biały white белый
KO-CMB200-PW-10*		200	145	160				
KO-CMB300-PW-10*		300	245	260				
KO-CMB150-PW-OC		150	95	110		ocynk galwanizacja гальваника		srebrny silver серебристый
KO-CMB200-PW-OC		200	145	160				
KO-CMB300-PW-OC*		300	245	260				



*Produkt dostępny na indywidualne zamówienie / Available for special orders / Товар доступен под заказ

Ociekarka dwupoziomowa do montażu
Two tier dish drying rack
Двухуровневая сушилка для посуды (монтаж)



OC-A0150-06		
OC-A0160-06	stal szcztokowana brushed steel шлифованная сталь	stal nierdzewna stainless steel нержавеющая сталь
OC-A0170-06		
OC-A0180-06		
OC-A0190-06		

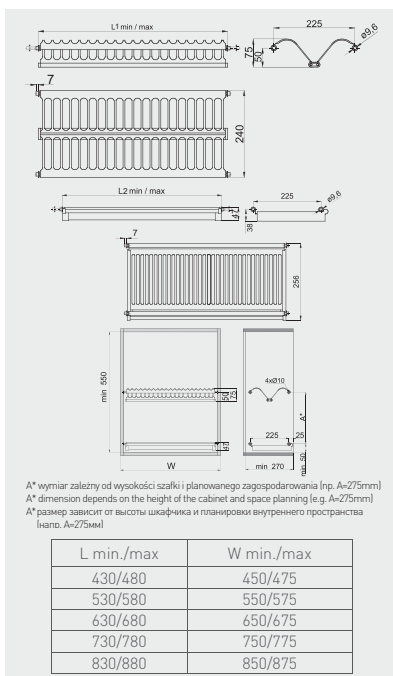

Ociekarka jednopoziomowa do montażu
Dish drying rack
Сушилка для посуды (монтаж)





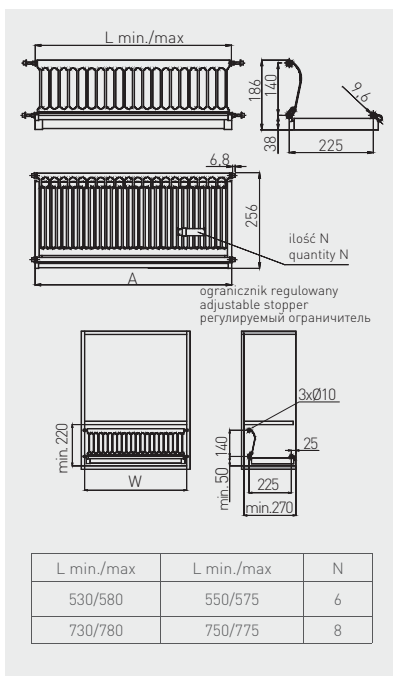

OC-A0660-06	stal szcztokowana brushed steel шлифованная сталь	stal nierdzewna stainless steel нержавеющая сталь
OC-A0680-06		

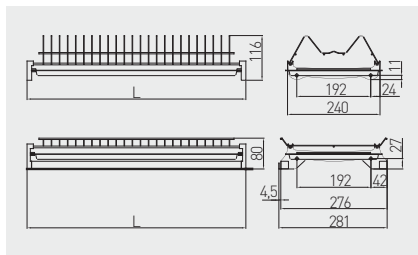

Осiekarka dwupoziomowa do montažu
Two tier dish drying rack
Двухуровневая сушилka для посуды (встраиваемая)



		 L mm		
OC-2PV340-01	do płyty 16 mm for 16 mm board для поверхности 16 мм	368	chrom chrome хром	stal nierdzewna, tworzywo stainless steel, plastic нержавеющая сталь, пластмасса
OC-2PV350-01		468		
OC-2PV360-01		568		
OC-2PV370-01		668		
OC-2PV380-01		768		
OC-2PV390-01		868		
OC-2PV340-01-18	do płyty 18 mm for 18 mm board для поверхности 18 мм	364		
OC-2PV350-01-18		464		
OC-2PV360-01-18		564		
OC-2PV370-01-18		664		
OC-2PV380-01-18		764		
OC-2PV390-01-18		864		



Ociekarka dwupoziomowa A04, wolnostojąca
 Two tier dish drying rack A04
 Сушилка для посуды настольная A04, двухуровневая

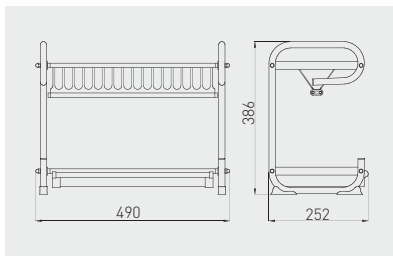



 OC-A0450-06	 stal szczotkowana brushed steel шлифованная сталь	 stal nierdzewna stainless steel нержавеющая сталь
--	--	--

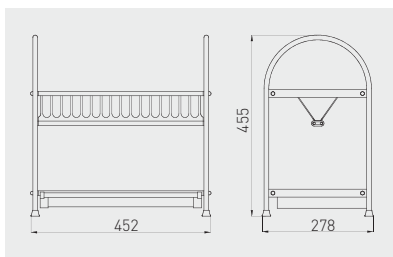

Ociekarka dwupoziomowa A03, wolnostojąca
 Two tier dish drying rack A03
 Сушилка для посуды настольная A03, двухуровневая



 OC-A0350K-06	 stal szczotkowana brushed steel шлифованная сталь	 stal nierdzewna stainless steel нержавеющая сталь
---	--	--



Ociekarka dwupoziomowa z organizerem, wolnostojąca
 Two tier dish drying rack with organizer
 Сушилка для посуды и столовых приборов настольная, двухуровневая

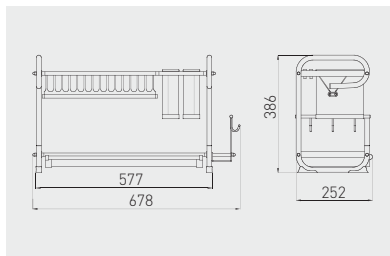

		
OC-A0460D-06	stal szcztokowana brushed steel шлифованная сталь	stal nierdzewna stainless steel нержавеющая сталь



Ociekarka zwijana
 Roll-up drying rack
 Складная сушилка

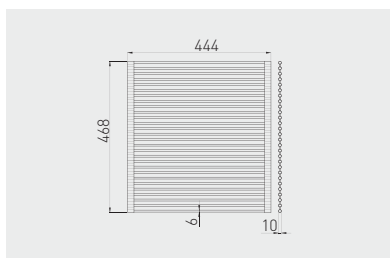

		
OC-E0707D-CZ	stal szcztokowana, czarny brushed steel, black шлифованная сталь, чёрный	stal nierdzewna stainless steel нержавеющая сталь





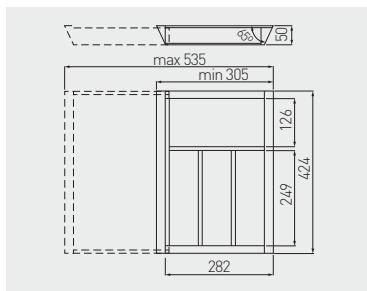

Wkład CUSTOMI A regulowany Adjustable cutlery organizer CUSTOMI A Вкладыш CUSTOMI A с возможностью регулировки



Do szuflad Modern Box i Axis L450
For Modern Box or Axis L=450 mm
Подходит для ящиков Modern Box/Axis L=450 мм

Maksymalny wysuw = 535 mm
Maximum extension = 535 mm
Максимальное выдвижение = 535 мм

				
W-CUSTOMI-60L450	424 x 305	lakier bezbarwny matowy clearcoat matt surface лак матовый бесцветный	buk beech бук	drewno buk beech wood дерево бука



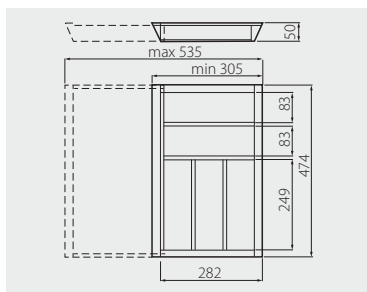

Wkład CUSTOMI BIS A regulowany Adjustable cutlery organizer CUSTOMI BIS A Вкладыш CUSTOMI BIS A с возможностью регулировки



Do szuflad Modern Box i Axis L=500
For Modern Box or Axis L=500 mm
Подходит для ящиков Modern Box/Axis L=500 мм

Maksymalny wysuw = 535 mm
Maximum extension = 535 mm
Максимальное выдвижение = 535 мм

				
W-CUSTOMI-60L500	474 x 305	lakier bezbarwny matowy clearcoat matt surface лак матовый бесцветный	buk beech бук	drewno buk beech wood дерево бука



Wkład CUSTOMI B regulowany Adjustable cutlery organizer CUSTOMI B Вкладыш CUSTOMI B с возможностью регулировки

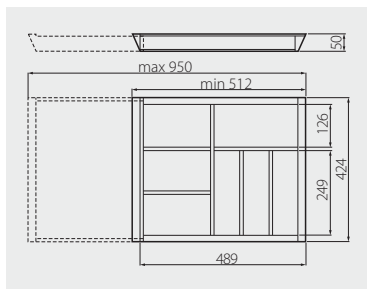

Do szuflad Modern Box i Axis L=450
For Modern Box or Axis L=450 mm
Подходит для ящиков Modern Box/Axis L=450 мм

Maksymalny wysuw = 950 mm
Maximum extension = 950 mm
Максимальное выдвижение = 950 мм



W-CUSTOMI-80L450	512 x 424	lakier bezbarwny matowy clearcoat matt surface лак матовый бесцветный	buk beech бук	drewno buk beech wood дерево бука
------------------	-----------	---	---------------------	---



Wkład CUSTOMI BIS B regulowany Adjustable cutlery organizer CUSTOMI BIS B Вкладыш CUSTOMI BIS B с возможностью регулировки

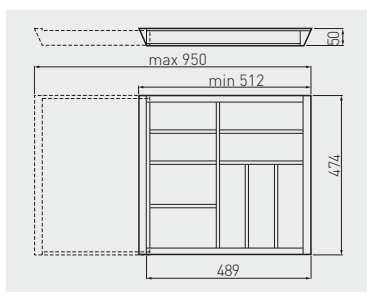

Do szuflad Modern Box i Axis L=500
For Modern Box or Axis L=500 mm
Подходит для ящиков Modern Box/Axis L=500 мм

Maksymalny wysuw = 950 mm
Maximum extension = 950 mm
Максимальное выдвижение = 950 мм



W-CUSTOMI-80L500	512 x 474	lakier bezbarwny matowy clearcoat matt surface лак матовый бесцветный	buk beech бук	drewno buk beech wood дерево бука
------------------	-----------	---	---------------------	---



Wkład INSERTI A
Cutlery organizer INSERTI A
Универсальный вкладыш INSERTI A

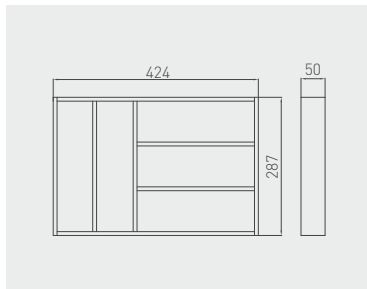

Do szuflad Modern Box i Axis L=450
For Modern Box or Axis L=450 mm
Подходит для ящиков Modern Box/Axis L=450 мм



W-INSERTI-L450

424 x 287

lakier bezbarwny matowy
clearcoat matt surface
лак матовый бесцветный

buk
beech
бук

drewno buk
beech wood
дерево бука



Wkład INSERTI B
Cutlery organizer INSERTI B
Универсальный вкладыш INSERTI B

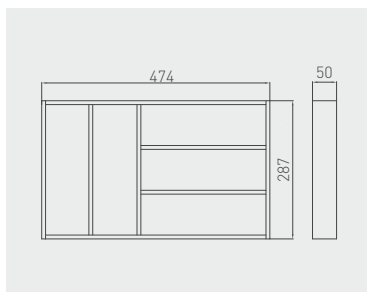

Do szuflad Modern Box i Axis L=500
For Modern Box or Axis L=500 mm
Подходит для ящиков Modern Box/Axis L=500 мм



W-INSERTI-L500

474 x 287

lakier bezbarwny matowy
clearcoat matt surface
лак матовый бесцветный



buk
beech
бук

drewno buk
beech wood
дерево бука

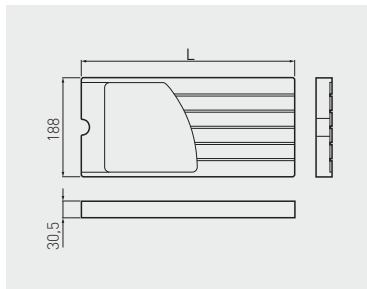

Blok KNIFI na noże
 Knife block KNIFI
 Вставка KNIFI для ножей







	 mm			
W-AKC-KNIFI-L450	405	lakier bezbarwny matowy clearcoat matt surface лак матовый бесцветный	buk beech бук	drewno buk beech wood дерево бука
W-AKC-KNIFI-L500	455			

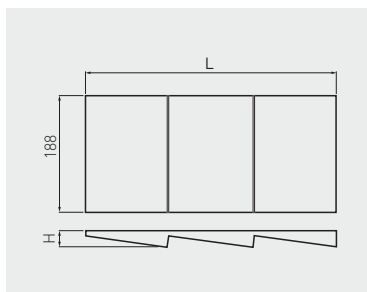

Blok HERBI na przyprawę
 Spice tray HERBI
 Вставка HERBI для специй







	 mm	 mm			
W-AKC-HERBI-L450	405	24	lakier bezbarwny matowy clearcoat matt surface лак матовый бесцветный	buk beech бук	drewno buk beech wood дерево бука
W-AKC-HERBI-L500	455	26			

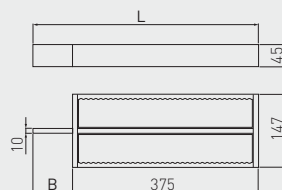

Uchwyt HOLDI na folię
 Foil roll dispenser HOLDI
 Вставка HOLDI для фольги и пленки



	 mm			
W-AKC-HOLDI-L450	405 x 147	lakier bezbarwny matowy clearcoat matt surface лак матовый бесцветный	buk beech бук	drewno buk beech wood дерево бука
W-AKC-HOLDI-L500	455 x 147			



Mata antypoślizgowa do szuflad
 Anti-slip mat for drawers
 Противоскользящий коврик для ящиков



	 mm		
MA-MATA-0-00	1500 x 470	przeźroczysty transparent прозрачный	tworzywo plastic пластмасса



Półka pod klawiaturę z prowadnicą kulkową 27 mm
 Keyboard shelf with 27 mm drawer slide
 Полка для клавиатуры с шариковой направляющей 27 мм

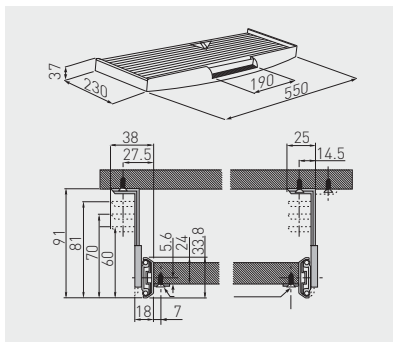

PU-KEY027-20	czarny / black / чёрны	tworzywo plastic пластмасса
PU-KEY027-60	szary / gray / серый	



Półka pod klawiaturę z podkładką na myszkę
 Keyboard shelf with mouse pad
 Полка для клавиатуры с подставкой для мыши

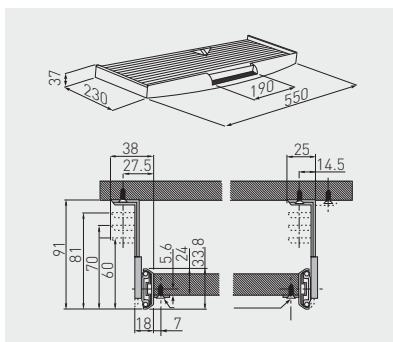

PU-KEYM27-20	czarny / black / чёрны	tworzywo plastic пластмасса
PU-KEYM27-60	szary / gray / серый	



Wózek pod komputer
Computer trolley
Передвижная подставка под компьютер

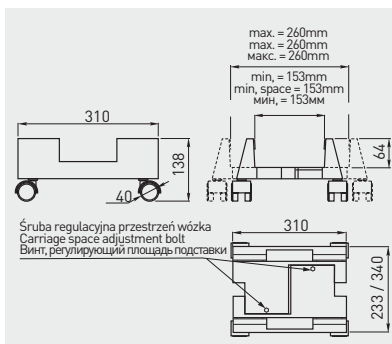
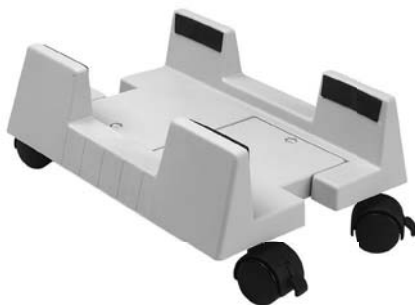

PU-PKO-00-20	czarny / black / чёрны	tworzywo plastic пластмасса
PU-PKO-00-60	szary / gray / серый	



Hub – 4 porty USB
Hub – 4 USB ports
Удлинитель на 4 входа USB

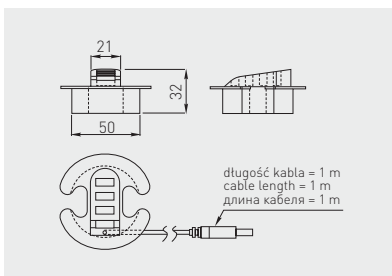

HB-USB-4X-20	czarny / black / чёрный	tworzywo plastic пластмасса
HB-USB-4X-60	srebrny / silver / серебряный	



Przepust MERIDA 80
Desk cable outlet MERIDA 80
Пропуск для кабеля MERIDA 80

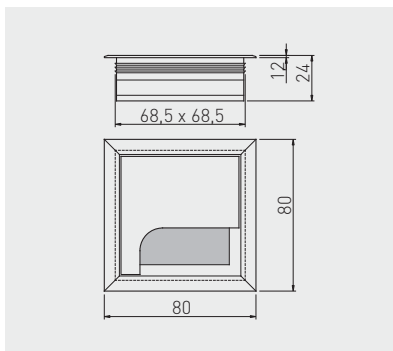





	 mm		
LB-K80X80-05	80 x 80	aluminium / aluminium / алюминий	aluminium aluminium алюминий
LB-K80X80-20		czarny / black / чёрный	

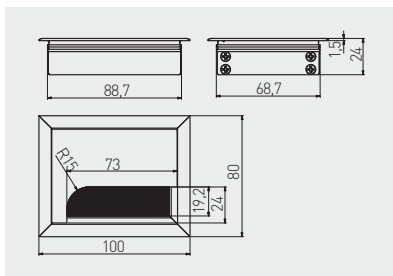

Przepust MERIDA 100
Desk cable outlet MERIDA 100
Пропуск для кабеля MERIDA 100





	 mm		
LB-K80X100-05	80 x 100	aluminium / aluminium / алюминий	aluminium aluminium алюминий
LB-K80X100-20		czarny / black / чёрный	

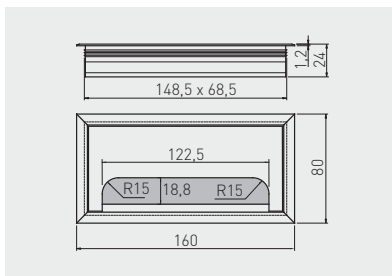

Przepust MERIDA 160
Desk cable outlet MERIDA 160
Пропуск для кабеля MERIDA 160







	 mm		
LB-80X160-05	80 x 160	aluminium / aluminium / алюминий	aluminium aluminium алюминий
LB-80X160-20		czarny / black / чёрный	

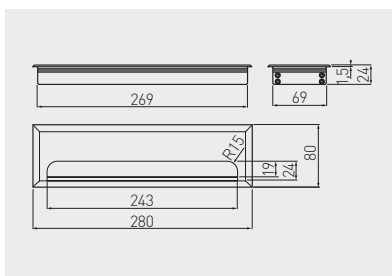

Przepust MERIDA 280
Desk cable outlet MERIDA 280
Пропуск для кабеля MERIDA 280



	 mm		
LB-80X280-05	80 x 280	aluminium / aluminium / алюминий	aluminium aluminium алюминий
LB-80X280-20		czarny / black / чёрный	



Przepust MERIDA 500
Desk cable outlet MERIDA 500
Пропуск для кабеля MERIDA 500

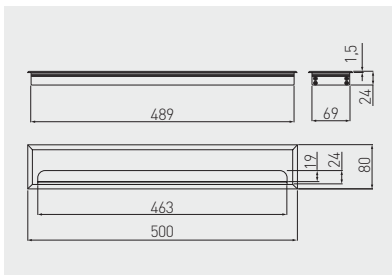

LB-80X500-05	80 x 500 mm	aluminium / aluminium / алюминий	aluminium aluminium алюминий
LB-80X500-20		czarny / black / чёрный	



Przepust LBF
Desk cable grommet LBF
Пропуск для кабеля LBF

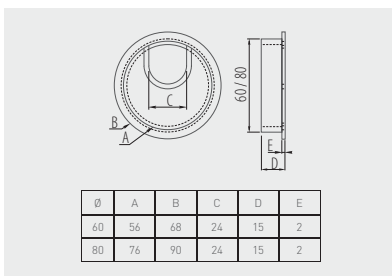

PM-LBF160-01	60	chrom / chrome / хром	ZnAl
PM-LBF160-02		satyna / satin / сатин	
PM-LBF160-05		aluminium / aluminium / алюминий	
PM-LBF160-06		stal szcztokowana / brushed steel / шлифованная сталь	
PM-LBF180-01	80	chrom / chrome / хром	
PM-LBF180-02		satyna / satin / сатин	
PM-LBF180-05		aluminium / aluminium / алюминий	
PM-LBF180-06		stal szcztokowana / brushed steel / шлифованная сталь	



Przepust PLF
 Desk cable grommet PLF
 Пропуск для кабеля PLF

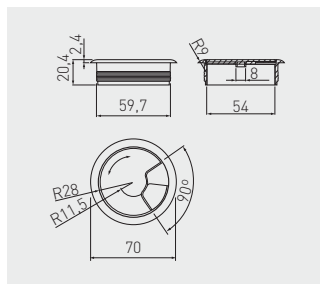



PM-PLFI60-02	satyna / satin / сатин	tworzywo plastic пластмасса
PM-PLFI60-05	aluminium / aluminium / алюминий	
PM-PLFI60-10	biały / white / белый	
PM-PLFI60-20	czarny / black / чёрный	
PM-PLFI60-30	popiel / gray / серый	
PM-PLFI60-41	olcha / alder / ольха	
PM-PLFI60-42	grusza / pear / груша	
PM-PLFI60-43	jasny brąz / light brown / светло-коричневый	
PM-PLFI60-44	buk / beech / бук	
PM-PLFI60-45	orzech / walnut / цвет орех	
PM-PLFI60-46	rustikal / rustical / рустикал	
PM-PLFI60-47	buk / beech / бук	
PM-PLFI60-48	mahoń / mahogany / красное дерево	
PM-PLFI60-49	klon / maple / клен	
PM-PLFI60-50	beż / beige / бежевый	
PM-PLFI60-51	kalwados / calvados / кальвадос	
PM-PLFI60-52	wiśnia / cherry / вишня	
PM-PLFI60-58	wenge / venge / венге	

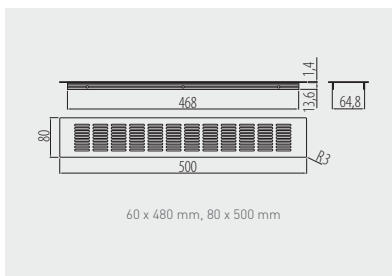

Kratka wentylacyjna D50-80
Plinth vent D50-80
Вентиляционная решётка D50-80



			
KK-D50-80-06	przepustowość powietrza - 108 cm ² air throughput - 108 cm ² прохождение воздушного потока - 108 см ²	stal szczotkowana brushed steel шлифованная сталь	aluminium aluminium алюминий



Kratka wentylacyjna D50-100
Plinth vent D50-100
Вентиляционная решётка D50-100

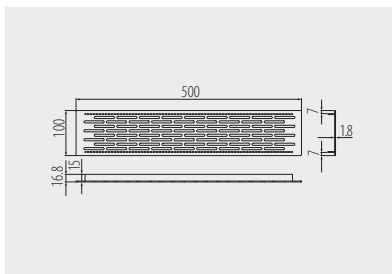





			
KK-D50100-06	przepustowość powietrza - 130 cm ² air throughput - 130 cm ² прохождение воздушного потока - 130 см ²	stal szczotkowana brushed steel шлифованная сталь	aluminium aluminium алюминий

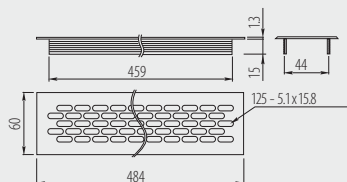

Kratka wentylacyjna W60
Plinth vent W60
Вентиляционная решётка W60





			
KK-W60800-M0	przepustowość powietrza - 94 cm ² air throughput - 94 cm ²	szary / gray / серый	aluminium aluminium
KK-W60800-M1	прохождение воздушного потока - 94 см ²	biały / white / белый	aluminium алюминий

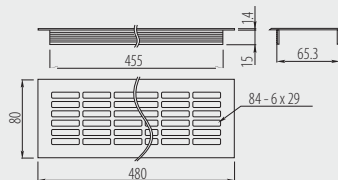

Kratka wentylacyjna W80
Plinth vent W80
Вентиляционная решётка W80







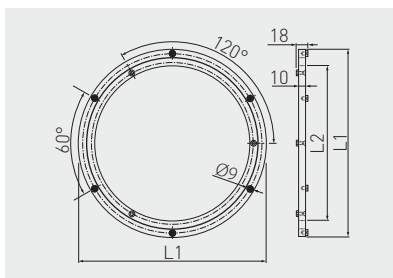

			
KK-W80800-D0	przepustowość powietrza - 146 cm ² air throughput - 146 cm ²	szary / gray / серый	aluminium aluminium
KK-W80800-D1	прохождение воздушного потока - 146 см ²	biały / white / белый	aluminium алюминий



Obrotnica okrągła
Round swivel bracket
Круглый поворотный кронштейн







		 L1 mm	 L2 mm	 kg		
	OM-OBO300-05	300	248	60	aluminium aluminium алюминий	aluminium aluminium алюминий
	OM-OBO350-05	350	298	80		
	OM-OBO400-05	400	338	100		

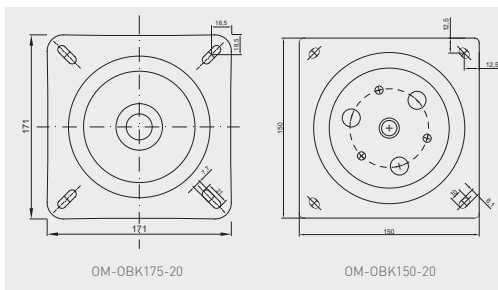

Obrotnica kwadratowa
Square swivel bracket
Поворотный кронштейн, квадратный



		 kg		
	OM-OBK150-20	50	czarny black чёрный	stal steel сталь
	OM-OBK175-20	100		



**AKCESORIA DEKORACYJNE
DECORATIVE ACCESSORIES
ЛИЦЕВАЯ ФУРНИТУРА**

Uchwyty Handles Ручки	268 – 361
Wieszaki Hooks Крючки	364 – 380
Nóżki meblowe Furniture legs Мебельные ножки	381 – 409
Nogi meblowe Furniture legs Мебельные опоры	410 – 416
Rolki meblowe Furniture castors Мебельные колёсики	417 – 421
Zamki meblowe Cabinet locks Замки	422 – 429





GTV

Uchwyt CLEO
Handle CLEO
Ручка CLEO

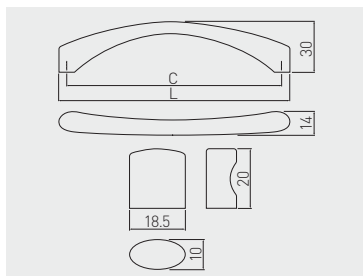

C
mm

L
mm



C	L	chrom chrome хром	aluminium aluminium алюминий	stal szczerkowana brushed steel шлифованная сталь	
128	137	UZ-CLEO-128-01	UZ-CLEO-128-05	UZ-CLEO-128-06	ZnAl
160	169	UZ-CLEO-160-01	UZ-CLEO-160-05	UZ-CLEO-160-06	
192	201	UZ-CLEO-192-01	UZ-CLEO-192-05	UZ-CLEO-192-06	
gatka knob ручка		GZ-CLEO-1-01	GZ-CLEO-1-05	GZ-CLEO-1-06	

Uchwyt SENIOR
Handle SENIOR
Ручка SENIOR

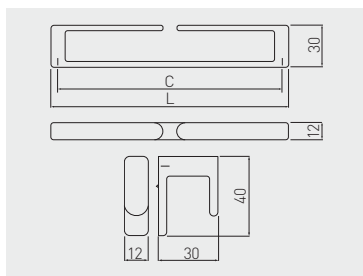

C
mm





L
mm

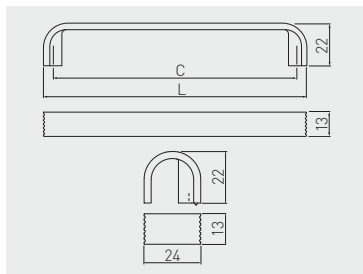

C	L	chrom chrome хром	aluminium aluminium алюминий	
160	170	UZ-SENIOR-160-01	UZ-SENIOR-160-05	ZnAl
gatka knob ручка		GZ-SENIOR-1-01	GZ-SENIOR-1-05	





Uchwyt VETA
Handle VETA
Ручка VETA

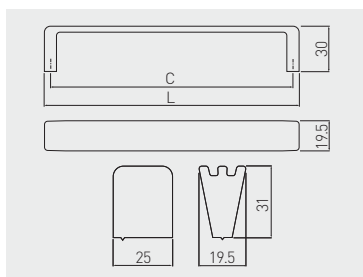

 C mm	 L mm			
128	138	chrom chrome хром	aluminium aluminium алюминий	czarny chrom black chrome чёрный хром
160	170	UZ-VETA-128-01	UZ-VETA-128-05	UZ-VETA-128-12
320	330	UZ-VETA-160-01	UZ-VETA-160-05	UZ-VETA-160-12
gatka knob ручка		UZ-VETA-320-01	UZ-VETA-320-05	UZ-VETA-320-12
		GZ-VETA-1-01	GZ-VETA-1-05	GZ-VETA-1-12

Uchwyt GANZA
Handle GANZA
Ручка GANZA



 C mm	 L mm			
160	168	chrom chrome хром	aluminium aluminium алюминий	biały white белый
		UZ-GANZA-160-01	UZ-GANZA-160-05	UZ-GANZA-160-10
gatka knob ручка		UZ-GANZA-160-01	UZ-GANZA-160-05	UZ-GANZA-160-12
		GZ-GANZA-1-01	GZ-GANZA-1-05	GZ-GANZA-1-10
				GZ-GANZA-1-12

Uchwyt AGIOS
Handle AGIOS
Ручка AGIOS

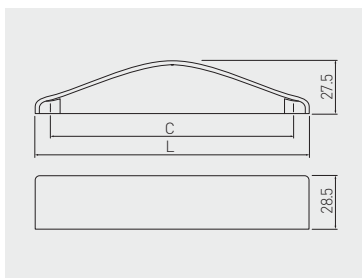

C mm	L mm			
128	144	chrom chrome хром	aluminium aluminium алюминий	ZnAl
		UZ-AGIOS-128-01	UZ-AGIOS-128-05	

Uchwyt HILL
Handle HILL
Ручка HILL

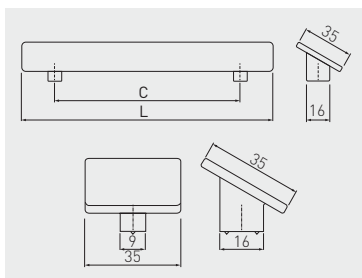

C mm	L mm					
128	173	chrom chrome хром	aluminium aluminium алюминий	stal szcztokowana brushed steel шлифованная сталь	czarny chrom black chrome чёрный хром	ZnAl
128	173	UZ-HILL-128-01	UZ-HILL-128-05	UZ-HILL-128-06	UZ-HILL-128-12	
160	205	UZ-HILL-160-01	UZ-HILL-160-05	UZ-HILL-160-06	UZ-HILL-160-12	
gatka knob ручка	-	GZ-HILL-1-01	GZ-HILL-1-05	GZ-HILL-1-06	GZ-HILL-1-12	

Uchwyt MONZA
Handle MONZA
Ручка MONZA

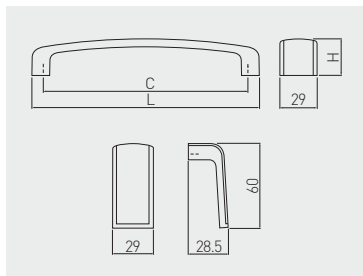

C mm	L mm	H mm				
			stal szczotkowana / chrom brushed steel / chrome шлифованная сталь / хром	biały / chrom white / chrome белый / хром	czarny / chrom black / chrome чёрный / хром	ZnAl, aluminium ZnAl, aluminium ZnAl, алюминий
16	29	28.5	UZ-MONZA16-06	UZ-MONZA16-10	UZ-MONZA16-20	
160	178	29	UZ-MONZA160-06	UZ-MONZA160-10	UZ-MONZA160-20	
256	274	33	UZ-MONZA256-06	UZ-MONZA256-10	UZ-MONZA256-20	
384	402	34	UZ-MONZA384-06	UZ-MONZA384-10	UZ-MONZA384-20	

Uchwyt MONA
Handle MONA
Ручка MONA

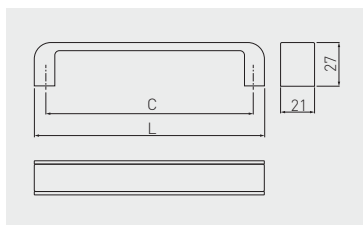

C mm	L mm			
		chrom / biały chrome / white хром / белый	chrom / czarny chrome / black хром / чёрный	ZnAl
128	142	UZ-MONA-128-01-10	UZ-MONA-128-01-20	
192	206	UZ-MONA-192-01-10	UZ-MONA-192-01-20	
256	270	UZ-MONA-256-01-10	UZ-MONA-256-01-20	

Uchwyt ACRYL
Handle ACRYL
Ручка ACRYL

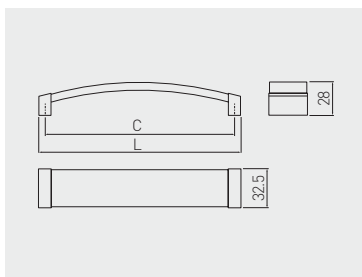

C mm	L mm			
160	170	chrom chrome хром	aluminium aluminium алюминий	ZnAl, акрил ZnAl, acryl ZnAl, акрил

* Produkt dostępny na indywidualne zamówienie / Available for special orders / Товар доступен под заказ

Uchwyt OLIVA
Handle OLIVA
Ручка OLIVA

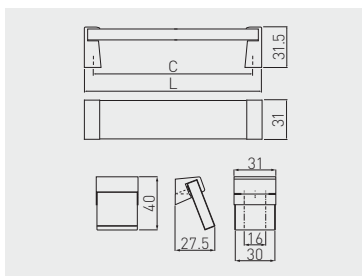

C mm	L mm			
160	174	chrom chrome хром		ZnAl, акрил ZnAl, acryl ZnAl, акрил
192	207	UZ-0160PR-01		
256	271	UZ-0192PR-01		
256	271	UZ-0256PR-01		
gatka knob ручка	-	GZ-OLIVA-16-01*		

* Produkt dostępny na indywidualne zamówienie / Available for special orders / Товар доступен под заказ

Uchwyt ROSES
Handle ROSES
Ручка ROSES

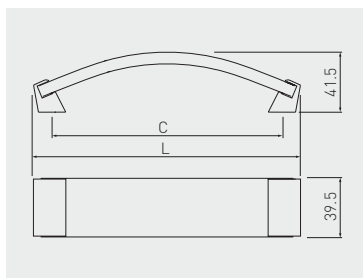

C mm		L mm			
		chrom / szkło przezroczyste chrome / transparent glass хром / прозрачное стекло	chrom / szkło białe chrome / white glass хром / белое стекло		
160	185	UZ-R160PR-01	UZ-R160BI-01	UZ-R0S160-20	
256	280	UZ-R256PR-01	UZ-R256BI-01	UZ-R0S256-20	

Uchwyt CADIS
Handle CADIS
Ручка CADIS

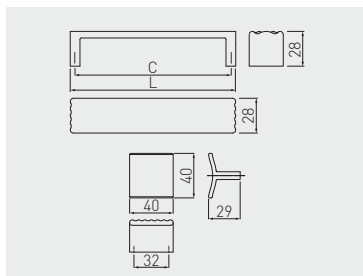

C mm		L mm			
		chrom chrome хром	aluminium aluminium алюминий		
32	40	GZ-CAD032-01	-		
128	136	UZ-CAD128-01	-		
160	168	UZ-CAD160-01	UZ-CAD160-05*		
320	328	UZ-CAD320-01	UZ-CAD320-05*		

* Produkt dostępny na indywidualne zamówienie / Available for special orders / Товар доступен под заказ

Uchwyt VERA*
Handle VERA*
Ручка VERA*

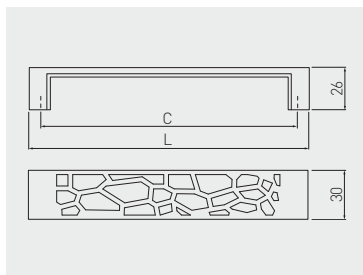



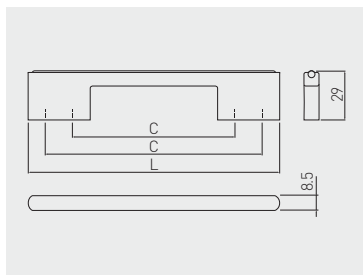

 C mm	 L mm		
160	174	cadm cadmium кадмий	ZnAl
UZ-VER160-08			

* Produkt dostępny na indywidualne zamówienie / Available for special orders / Товар доступен под заказ



Uchwyt ASTI
Handle ASTI
Ручка ASTI



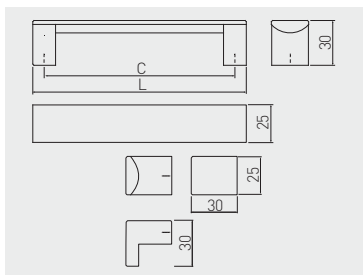

 C mm	 L mm		
96 / 128	148	chrom chrome хром	ZnAl
192 / 224	245	UZ-ASTI192/224-01	
288 / 320	340	UZ-ASTI288/320-01	

Uchwyt ARES
Handle ARES
Ручка ARES







C mm	L mm		
		czarny black чёрный	aluminium aluminium алюминий
96	111	UA-ARS096-20	
128	143	UA-ARS128-20	
160	175	UA-ARS160-20	
192	207	UA-ARS192-20	
224	239	UA-ARS224-20	

C mm	L mm		
		czarny black чёрный	aluminium aluminium алюминий
256	271	UA-ARS256-20	
320	335	UA-ARS320-20	
gatka knob ручка		UA-ARSG30-20	

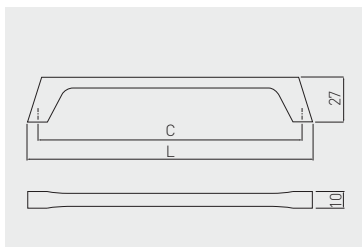

Uchwyt UZ-G2
Handle UZ-G2
Ручка UZ-G2



 C mm	 L mm		
		chrom chrome хром	stal szczotkowana brushed steel шлифованная сталь
160	172	UZ-G2-160-01	UZ-G2-160-06
224	236	UZ-G2-224-01	UZ-G2-224-06

ZnAl

Uchwyt TIVOLI
Handle TIVOLI
Ручка TIVOLI

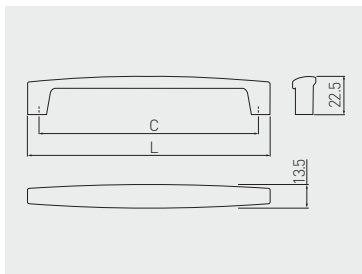

 C mm	 L mm		
		chrom chrome хром	czarny chrom black chrome чёрный хром
192	206	UZ-TIVOL-192-01	UZ-TIVOL-192-12
320	334	UZ-TIVOL-320-01	UZ-TIVOL-320-12

tytan
titanium
титан

ZnAl

Uchwyt BAGIO
Handle BAGIO
Ручка BAGIO

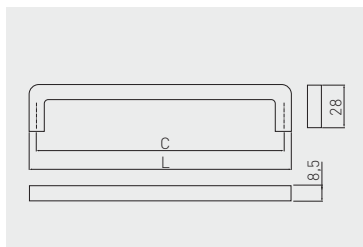

C
mm

L
mm



		chrom chrome хром	antyczny mosiądz antique brass античная латунь	aluminium aluminium алюминий	stal szczotkowana brushed steel шлифованная сталь	
128	136	UZ-BAGIO-128-01	UZ-BAGIO-128-04	UZ-BAGIO-128-05	UZ-BAGIO-128-06	ZnAl
160	168	UZ-BAGIO-160-01	UZ-BAGIO-160-04	UZ-BAGIO-160-05	UZ-BAGIO-160-06	
192	200	UZ-BAGIO-192-01	UZ-BAGIO-192-04	UZ-BAGIO-192-05	UZ-BAGIO-192-06	
320	328	UZ-BAGIO-320-01	UZ-BAGIO-320-04	UZ-BAGIO-320-05	UZ-BAGIO-320-06	

C
mm

L
mm



		antyczne srebro antique silver античное серебро	tytan szczotkowany brushed titanium шлифованный титан	czarny mat black matt чёрный матовый	
128	136	UZ-BAGIO-128-07	UZ-BAGIO-128-11	UZ-BAGIO-128-20M	ZnAl
160	168	UZ-BAGIO-160-07	UZ-BAGIO-160-11	UZ-BAGIO-160-20M	
192	200	UZ-BAGIO-192-07	UZ-BAGIO-192-11	UZ-BAGIO-192-20M	
320	328	UZ-BAGIO-320-07	UZ-BAGIO-320-11	UZ-BAGIO-320-20M	



Uchwyt PRATO
Handle PRATO
Ручка PRATO

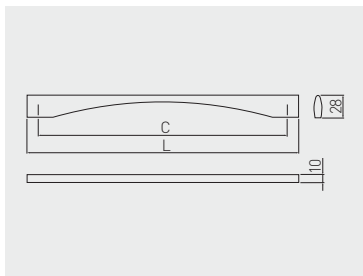

C mm	L mm				
		chrom chrome хром	aluminium aluminium алюминий	stal szczotkowana brushed steel шлифованная сталь	ZnAl
160	189	UZ-PRATO-160-01	UZ-PRATO-160-05	UZ-PRATO-160-06	
320	349	UZ-PRATO-320-01	UZ-PRATO-320-05	UZ-PRATO-320-06	



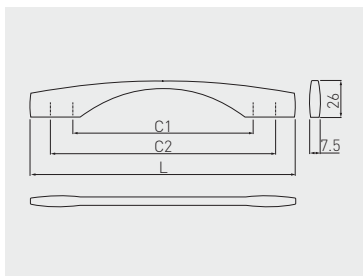

Uchwyt ANCONA
Handle ANCONA
Ручка ANCONA

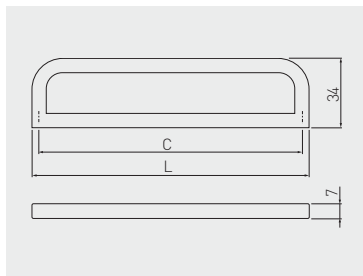

C1 mm	C2 mm	L mm			
			chrom chrome хром	aluminium aluminium алюминий	stal szczotkowana brushed steel шлифованная сталь
128	160	190	UZ-ANCON-128-01	UZ-ANCON-128-05	UZ-ANCON-128-06
192	224	254	UZ-ANCON-192-01	UZ-ANCON-192-05	UZ-ANCON-192-06
256	288	318	UZ-ANCON-256-01	UZ-ANCON-256-05	UZ-ANCON-256-06



Uchwyt PADWA
Handle PADWA
Ручка PADWA

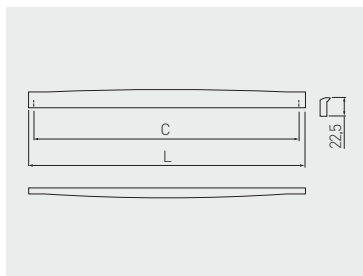

 mm	 mm		
192	199	chrom chrome хром	stal szcztokowana brushed steel шлифованная сталь
		UZ-PADWA192-01	UZ-PADWA192-06
ZnAl			

Uchwyt KATANIA
Handle KATANIA
Ручка KATANIA



 mm	 mm		
320	334	chrom chrome хром	czarny chrom black chrome чёрный хром
		UZ-KATAN-320-01	UZ-KATAN-320-12
ZnAl			

Gatka IMOLA
Knob IMOLA
Ручка IMOLA

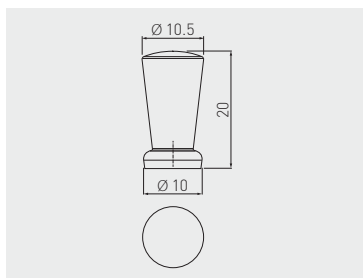

MODERN



	chrom chrome хром	satyna satin сатин	aluminium aluminium алюминий	stal szczotkowana brushed steel шлифованная сталь	ZnAl
gatka knob ручка	GZ-IMOLA-1-01	GZ-IMOLA-1-02	GZ-IMOLA-1-05	GZ-IMOLA-1-06	

Gatka ROMA
Knob ROMA
Ручка ROMA

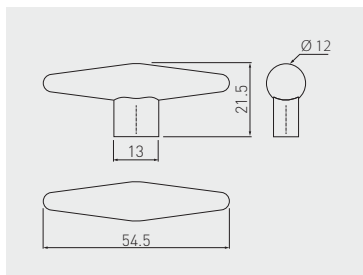

	chrom chrome хром	satyna satin сатин	aluminium aluminium алюминий	stal szczotkowana brushed steel шлифованная сталь	ZnAl
gatka knob ручка	GZ-ROMA-1-01	GZ-ROMA-1-02	GZ-ROMA-1-05	GZ-ROMA-1-06	

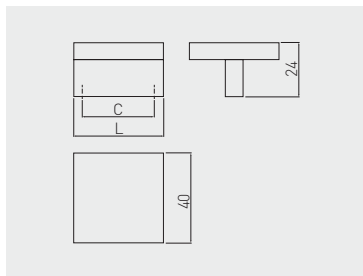

Uchwyt UZ-40
Handle UZ-40
Ручка UZ-40

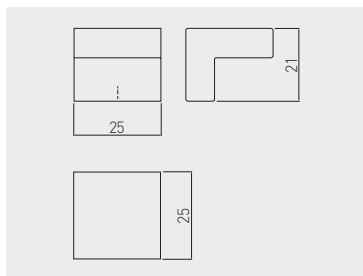

 C mm	 L mm					
32	40	chrom chrome хром	satyna satin сатин	aluminium aluminium алюминий	stal szorstkowana brushed steel шлифованная сталь	ZnAl
		UZ-40-032-01	UZ-40-032-02	UZ-40-032-05	UZ-40-032-06	

Uchwyt UZ-55
Handle UZ-55
Ручка UZ-55



	 L mm			
gatka knob ручка	25	chrom chrome хром	aluminium aluminium алюминий	ZnAl
		UZ-55-025-01	UZ-55-025-05	

Uchwyt UZ-60
Handle UZ-60
Ручка UZ-60

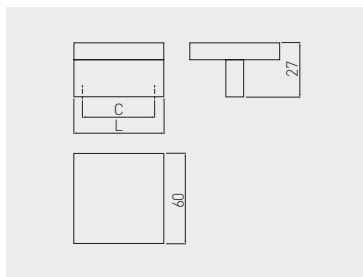
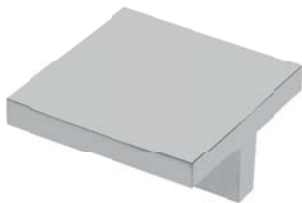

C mm	L mm					
		chrom chrome хром	satyna satin сатин	aluminium aluminium алюминий	stal szczotkowana brushed steel шлифованная сталь	ZnAl
32	60	UZ-60-032-01	UZ-60-032-02	UZ-60-032-05	UZ-60-032-06	

Uchwyt UZ-79F
Handle UZ-79F
Ручка UZ-79F

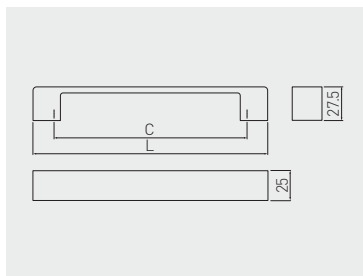

C mm	L mm				
		chrom chrome хром	stal szczotkowana brushed steel шлифованная сталь		ZnAl
160	195	UZ-79F160-01	UZ-79F160-06		
192	227	UZ-79F192-01	UZ-79F192-06		

Uchwył MODENA
Handle MODENA
Ручка MODENA

NEW

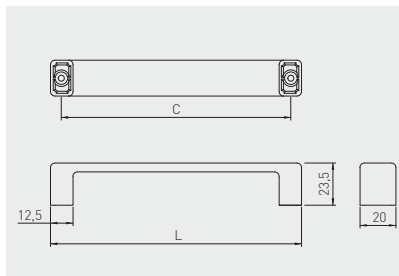

C
mm

L
mm



C	L	chrom chrome хром	aluminium aluminium алюминий	stal szczotkowana brushed steel шлифованная сталь	czarny mat black matt чёрный матовый	ZnAl
128	140	UZ-MODEN-128-01	UZ-MODEN-128-05	UZ-MODEN-128-06	UZ-MODEN-128-20M	ZnAl
160	172	UZ-MODEN-160-01	UZ-MODEN-160-05	UZ-MODEN-160-06	UZ-MODEN-160-20M	
192	204	UZ-MODEN-192-01	UZ-MODEN-192-05	UZ-MODEN-192-06	UZ-MODEN-192-20M	



MODERN

Uchwyt VARES
Handle VARES
Ручка VARES

MODERN

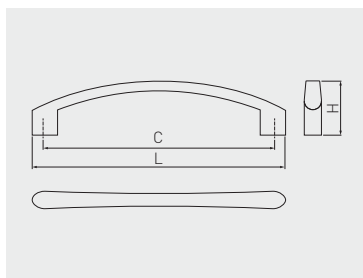

C mm	L mm	H mm	chrom chrome хром	satyna satin сатин	aluminium aluminium алюминий	stal szczerkowna brushed steel шлифованная сталь	ZnAl
96	109	29	UZ-VARES-96-01	UZ-VARES-96-02	UZ-VARES-96-05	UZ-VARES-96-06	ZnAl
128	140	30	UZ-VARES-128-01	UZ-VARES-128-02	UZ-VARES-128-05	UZ-VARES-128-06	
192	208	31	UZ-VARES-192-01	UZ-VARES-192-02	UZ-VARES-192-05	UZ-VARES-192-06	

Uchwyt UZ-133
Handle UZ-133
Ручка UZ-133

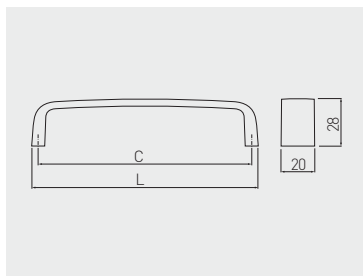



C mm	L mm	chrom chrome хром	satyna satin сатин	aluminium aluminium алюминий	stal szczerkowna brushed steel шлифованная сталь	ZnAl
128	135	UZ-133128-01	UZ-133128-02	UZ-133128-05	UZ-133128-06	ZnAl



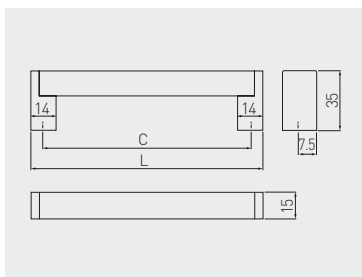

Uchwyt UZ-334
Handle UZ-334
Ручка UZ-334

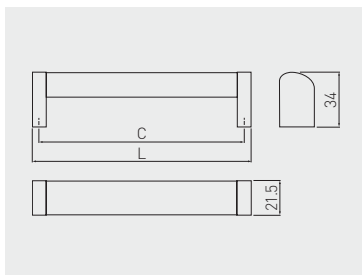

C mm	L mm		
		stal szczotkowana brushed steel шлифованная сталь	ZnAl, stal ZnAl, steel ZnAl, сталь
128	144	UZ-334128-06	
160	175	UZ-334160-06	
192	206	UZ-334192-06	
256	272	UZ-334256-06	
320	335	UZ-334320-06	

Uchwyt UZ-335
Handle UZ-335
Ручка UZ-335



C mm	L mm		
		stal szczotkowana brushed steel шлифованная сталь	ZnAl, stal ZnAl, steel ZnAl, сталь
128	137	UZ-335128-06	
160	169	UZ-335160-06	
192	201	UZ-335192-06	
256	265	UZ-335256-06	

Uchwyt UZ-336
Handle UZ-336
Ручка UZ-336

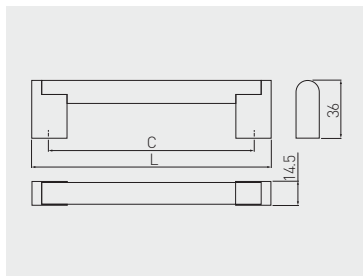

C mm	L mm		
		stal szczotkowana brushed steel шлифованная сталь	ZnAl, stal ZnAl, steel ZnAl, сталь
128	148	UZ-336128-06	
160	182	UZ-336160-06	
192	213	UZ-336192-06	
256	276	UZ-336256-06	
320	340	UZ-336320-06	
416	436	UZ-336416-06	
480	500	UZ-336480-06	

Uchwyt UZ-682
Handle UZ-682
Ручка UZ-682

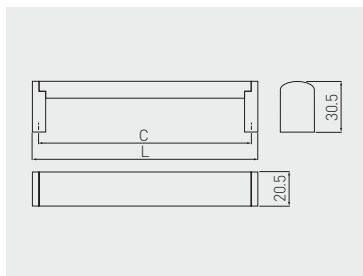

C mm	L mm			C mm	L mm		
		stal szczotkowana brushed steel шлифованная сталь	stal, ZnAl steel, ZnAl сталь, ZnAl			stal szczotkowana brushed steel шлифованная сталь	stal, ZnAl steel, ZnAl сталь, ZnAl
128	136	UZ-682128-06					
160	170	UZ-682160-06					
192	209	UZ-682192-06					
224	232	UZ-682224-06					
256	266	UZ-682256-06		416	425	UZ-682416-06	
320	329	UZ-682320-06		480	489	UZ-682480-06	

Uchwyt UZ-804
Handle UZ-804
Ручка UZ-804

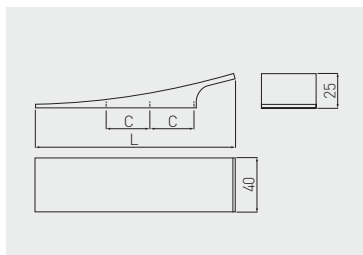

C mm	L mm		
32*	145	chrom chrome хром	ZnAl
		UZ-804064-01	

* Mocowanie na 3 wkręty / Mounted with 3 screws / Крепление на 3 самореза.

Uchwyt MILANO
Handle MILANO
Ручка MILANO

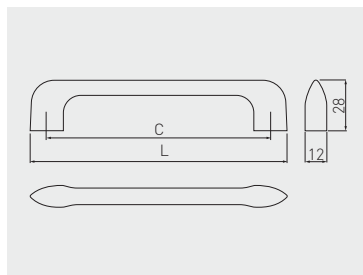

C mm	L mm					
C	L	chrom chrome хром	aluminium aluminium алюминий	stal szcztokowana brushed steel шлифованная сталь	czarny mat black matt чёрный матовый	ZnAl
128	146	UZ-MILAN-128-01	UZ-MILAN-128-05	UZ-MILAN-128-06	UZ-MILAN-128-20M	
256	274	UZ-MILAN-256-01	UZ-MILAN-256-05	UZ-MILAN-256-06	UZ-MILAN-256-20M	
gałka knob ручка		GZ-MILAN-32-01	GZ-MILAN-32-05	GZ-MILAN-32-06	GZ-MILAN-32-20M	

Uchwyty CAPRI
Handle CAPRI
Ручка CAPRI

NEW

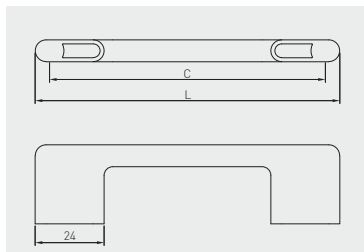

C
mm

L
mm



C	L	chrom chrome хром	satyna satin сатин	aluminium aluminium алюминий	stal szcztokowana brushed steel шлифованная сталь	
96	106	UZ-CAPRI-96-01	UZ-CAPRI-96-02	UZ-CAPRI-96-05	UZ-CAPRI-96-06	ZnAl
128	138	UZ-CAPRI-128-01	UZ-CAPRI-128-02	UZ-CAPRI-128-05	UZ-CAPRI-128-06	
160	170	UZ-CAPRI-160-01	UZ-CAPRI-160-02	UZ-CAPRI-160-05	UZ-CAPRI-160-06	
192	202	UZ-CAPRI-192-01	UZ-CAPRI-192-02	UZ-CAPRI-192-05	UZ-CAPRI-192-06	
256	266	UZ-CAPRI-256-01	UZ-CAPRI-256-02	UZ-CAPRI-256-05	UZ-CAPRI-256-06	
320	330	UZ-CAPRI-320-01	UZ-CAPRI-320-02	UZ-CAPRI-320-05	UZ-CAPRI-320-06	



Uchwyty UZ-819
Handle UZ-819
Ручка UZ-819

MODERN

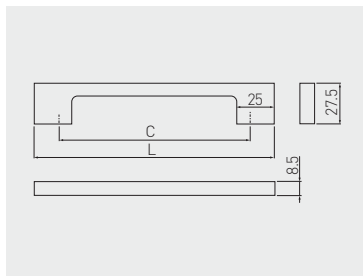

C mm	L mm						
C	L	chrom chrome хром	satyna satin сатин	aluminium aluminium алюминий	stal szczerkowana brushed steel шлифованная сталь	antyczne srebro antique silver античное серебро	ZnAl
96	129	UZ-819096-01	UZ-819096-02	UZ-819096-05	UZ-819096-06	UZ-819096-07	
128	161	UZ-819128-01	UZ-819128-02	UZ-819128-05	UZ-819128-06	UZ-819128-07	
160	193	UZ-819160-01	UZ-819160-02	UZ-819160-05	UZ-819160-06	UZ-819160-07	
192	225	UZ-819192-01	UZ-819192-02	UZ-819192-05	UZ-819192-06	UZ-819192-07	
256	289	UZ-819256-01	UZ-819256-02	UZ-819256-05	UZ-819256-06	UZ-819256-07	
320	353	UZ-819320-01	UZ-819320-02	UZ-819320-05	UZ-819320-06	UZ-819320-07	

C mm	L mm						
C	L	biały white белый	czarny black чёрный	czarny chrom black chrome чёрный хром	antyczna miedź antique copper античная медь	miedź copper медь	ZnAl
96	129	UZ-819096-10	UZ-819096-20	UZ-819096-12	UZ-819096-14	-	
128	161	UZ-819128-10	UZ-819128-20	UZ-819128-12	UZ-819128-14	UZ-819128-15	
160	193	UZ-819160-10	UZ-819160-20	UZ-819160-12	UZ-819160-14	UZ-819160-15	
192	225	UZ-819192-10	UZ-819192-20	UZ-819192-12	UZ-819192-14	UZ-819192-15	
256	289	UZ-819256-10	UZ-819256-20	UZ-819256-12	UZ-819256-14	UZ-819256-15	
320	353	UZ-819320-10	UZ-819320-20	UZ-819320-12	UZ-819320-14	-	

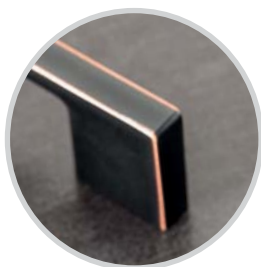

antyczna miedź
antique copper
античная медь







miedź
copper
медь

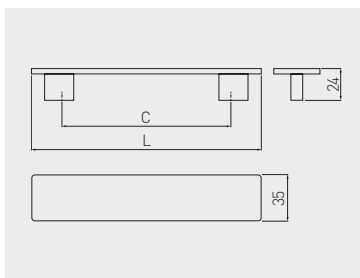

Uchwyt UZ-870
Handle UZ-870
Ручка UZ-870



 C mm	 L mm		
128	174	chrom chrome хром	ZnAl
UZ-870128-01			

Uchwyt UZ-872
Handle UZ-872
Ручка UZ-872

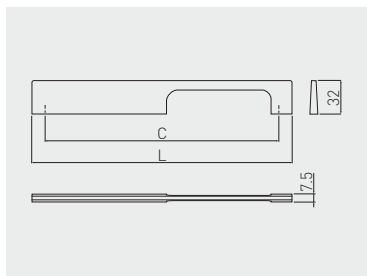
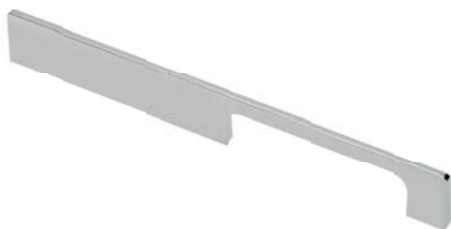

 C mm	 L mm		
224	249	chrom chrome хром	aluminium aluminium алюминий
UZ-872224-01		stal szcztokowana brushed steel шлифованная сталь	ZnAl
UZ-872224-05		UZ-872224-06	

Uchwyt EAST*
Handle EAST*
Ручка EAST*

NEW

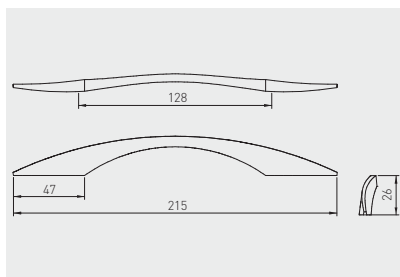

C mm	L mm				
		chrom chrome хром	stal szczotkowana brushed steel шлифованная сталь	szary mat grey matt серый матовый	ZnAl
128	215	UZ-EAST-128-01	UZ-EAST-128-06	UZ-EAST-128-19	

* Produkt dostępny na indywidualne zamówienie / Available for special orders / Товар доступен под заказ

Uchwyt UZ-880
Handle UZ-880
Ручка UZ-880

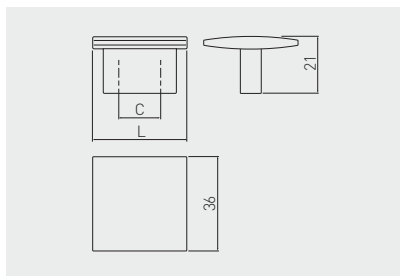

C mm	L mm			
		chrom chrome хром		ZnAl
16	36	UZ-880016-01		

Uchwyt UZ-883
Handle UZ-883
Ручка UZ-883



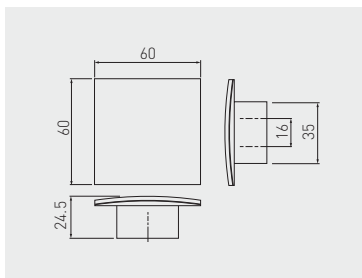

MODERN

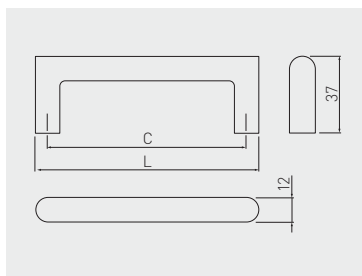

 C mm	 L mm					
		chrom chrome хром	satyna satin сатин	aluminium aluminium алюминий	stal szczotkowana brushed steel шлифованная сталь	ZnAl
16	60	UZ-883016-01	UZ-883016-02	UZ-883016-05	UZ-883016-06	

Uchwyt US-SKA
Handle US-SKA
Ручка US-SKA



 C mm	 L mm		
		stal szczotkowana brushed steel шлифованная сталь	stal steel сталь
128	140	US-SKA128-06	
160	172	US-SKA160-06	
192	204	US-SKA192-06	

Na indywidualne zamówienie dostępne również rozstawy: 96, 224, 320, 352, 560 (mm).

Other sizes are available for special orders: 96, 224, 320, 352, 560 (mm).

Под заказ доступны ручки с межцентровым расстоянием: 96, 224, 320, 352, 560 [мм].

Uchwyt US-SK0
Handle US-SK0
Ручка US-SK0

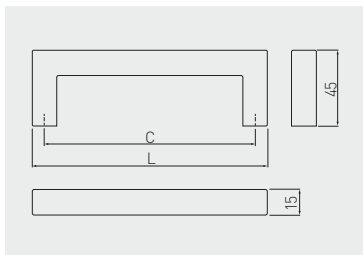

C mm	L mm		
		stal szczotkowana brushed steel шлифованная сталь	stal steel сталь
128	143	US-SK0128-06	
160	175	US-SK0160-06	
192	207	US-SK0192-06	
224	239	US-SK0224-06	
256	271	US-SK0256-06	
320	335	US-SK0320-06	

C mm	L mm		
		stal szczotkowana brushed steel шлифованная сталь	stal steel сталь
384	399	US-SK0384-06	
448	463	US-SK0448-06	
480	495	US-SK0480-06	
576	591	US-SK0576-06	
672	687	US-SK0672-06	
800	815	US-SK0800-06	

Uchwyt UA-A3
Handle UA-A3
Ручка UA-A3

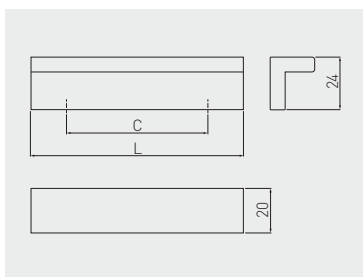

C mm	L mm		
		aluminium aluminium алюминий	aluminium aluminium алюминий
96	128	UA-A3-096128	
128	160	UA-A3-128160	
160	192	UA-A3-160192	
192	224	UA-A3-192224	
256	288	UA-A3-256288	
320	352	UA-A3-320352	

Uchwyt UA-A4 Handle UA-A4 Ручка UA-A4

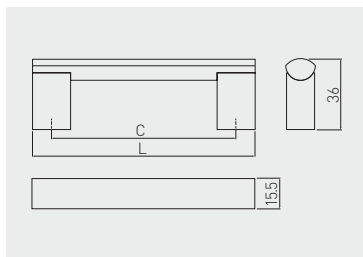

C mm	L mm				
		aluminium aluminium алюминий	stal szczotkowana brushed steel шлифованная сталь		
128	148	UA-AA-04-128	UA-A4-128-06MJ	aluminium aluminium алюминий	
160	180	UA-AA-04-160	UA-A4-160-06MJ		
192	212	UA-AA-04-192	*		
224	244	UA-AA-04-224	*		
256	276	UA-AA-04-256	UA-A4-256-06MJ		
288	308	UA-AA-04-288	*		
320	340	UA-AA-04-320	UA-A4-320-06MJ		

Uchwyt UA-B311 Handle UA-B311 Ручка UA-B311

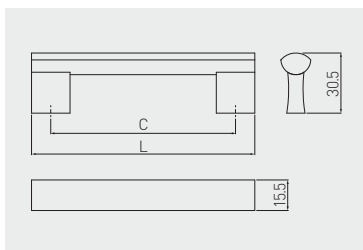

C mm	L mm					
		chrom chrome хром	aluminium aluminium алюминий	czarny black чёрный	stal szczotkowana brushed steel шлифованная сталь	
96	116	*	UA-B0-311096	UA-B0-311096-20M	UA-B31109606MJ*	aluminium aluminium алюминий
128	148	UA-B31112801	UA-B0-311128	UA-B0-311128-20M	UA-B31112806MJ*	
160	180	UA-B31116001	UA-B0-311160	UA-B0-311160-20M	UA-B31116006MJ*	
192	212	UA-B31119201	UA-B0-311192	UA-B0-311192-20M	UA-B31119206MJ*	
224	244	UA-B31122401	UA-B0-311224	UA-B0-311224-20M	UA-B31122406MJ*	
256	276	UA-B31125601	UA-B0-311256	UA-B0-311256-20M	UA-B31125606MJ*	
288	307	*	UA-B0-311288	*	UA-B31128806MJ*	
320	340	UA-B31132001	UA-B0-311320	UA-B0-311320-20M	UA-B31132006MJ*	
480	500	*	UA-B0-311480	*	UA-B31148006MJ*	

* Produkt dostępny na indywidualne zamówienie / Available for special orders / Товар доступен под заказ

Uchwyt UA-B337
Handle UA-B337
Ручка UA-B337

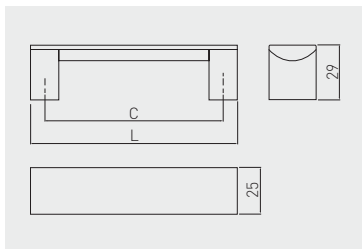

C mm	L mm	chrom chrome хром	aluminium aluminium алюминий	stal szczotkowana brushed steel шлифованная сталь	
128	143	UA-B33712801	UA-B0-337128	UA-B33712806MJ	aluminium aluminium алюминий
160	175	UA-B33716001	UA-B0-337160	UA-B33716006MJ	
192	207	UA-B33719201	UA-B0-337192	UA-B33719206MJ	
224	239	UA-B33722401	UA-B0-337224	UA-B33722406MJ	
256	271	UA-B33725601	UA-B0-337256	UA-B33725606MJ	
320	335	UA-B33732001	UA-B0-337320	UA-B33732006MJ	
416	431	*	UA-B0-337416	UA-B33741606MJ	
480	495	UA-B33748001	UA-B0-337480	UA-B33748006MJ	

* Produkt dostępny na indywidualne zamówienie / Available for special orders / Товар доступен под заказ

Uchwyt UA-114
Handle UA-114
Ручка UA-114

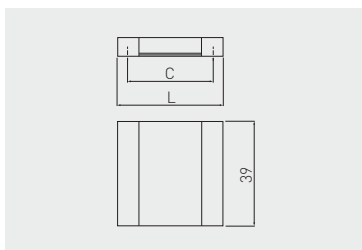

C mm	L mm	satyna satin сатин	aluminium aluminium алюминий	aluminium aluminium алюминий
32	39	UA-AA-114-02	UA-AA-114-05	

Uchwyt UA-18
Handle UA-18
Ручка UA-18

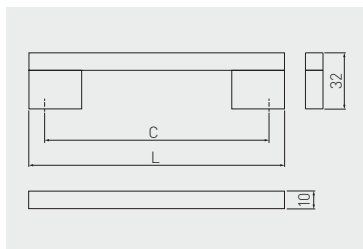

C
mm

L
mm



C mm	L mm	chrom chrome хром	aluminium aluminium алюминий	stal szcztokowana brushed steel шлифованная сталь	
128	146	UA-A18128-01	UA-18-128146	UA-A18128-06MJ	aluminium aluminium алюминий
160	178	UA-A18160-01	UA-18-160178	UA-A18160-06MJ	
192	210	UA-A18192-01	UA-18-192210	UA-A18192-06MJ	
224	242	UA-A18224-01	UA-18-224242	UA-A18224-06MJ	
256	274	UA-A18256-01	UA-18-256274	UA-A18256-06MJ	
320	338	UA-A18320-01	UA-18-320338	UA-A18320-06MJ	
400	418	UA-A18400-01	UA-18-400418	UA-A18400-06MJ	
416	434	UA-A18416-01	UA-18-416434	UA-A18416-06MJ	
480	498	UA-A18480-01	UA-18-480498	UA-A18480-06MJ	

Uchwyt UA-313
Handle UA-313
Ручка UA-313

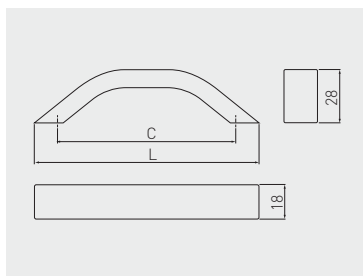

C
mm





L
mm

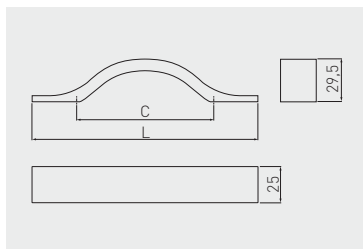

C mm	L mm	aluminium aluminium алюминий	
128	150	UA-00-313128	aluminium aluminium алюминий
160	182	UA-00-313160	
192	214	UA-00-313192	





Uchwyt UA-319
Handle UA-319
Ручка UA-319

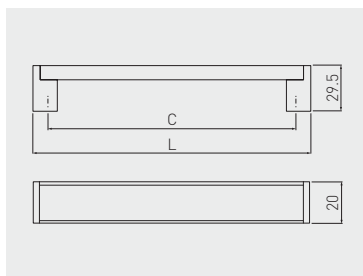

 C mm	 L mm		
		aluminium aluminium алюминий	aluminium aluminium алюминий
96	158	UA-00-319096	
128	189	UA-00-319128	
160	231	UA-00-319160	

Uchwyt LUNA*
Handle LUNA*
Ручка LUNA*



 C mm	 L mm		
		satyna / chrom satin / chrome сатин / хром	aluminium / chrom aluminium / chrome алюминий / хром
160	179	UA-LUNA20160-SN	UA-LUNA20160-AL
192	211	UA-LUNA20192-SN	UA-LUNA20192-AL
256	275	UA-LUNA20256-SN	UA-LUNA20256-AL
320	339	UA-LUNA20320-SN	UA-LUNA20320-AL

* Produkt dostępny na indywidualne zamówienie / Available for special orders / Товар доступен под заказ

Uchwyt VITO
Handle VITO
Ручка VITO

NEW

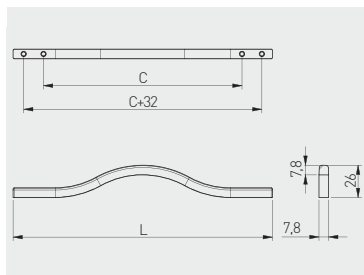

C
mm

L
mm

		chrom chrome хром	aluminium aluminium алюминий	antyczne srebro antique silver античное серебро	ZnAl
160	193	UZ-VITO-160-01	UZ-VITO-160-05	UZ-VITO-160-07	ZnAl
288	225	UZ-VITO-288-01	UZ-VITO-288-05	UZ-VITO-288-07	

C
mm

L
mm





		czarny chrom black chrome чёрный хром	czarny mat black matt чёрный матовый	ZnAl
160	193	UZ-VITO-160-12	UZ-VITO-160-20M	ZnAl
288	225	UZ-VITO-288-12	UZ-VITO-288-20M	

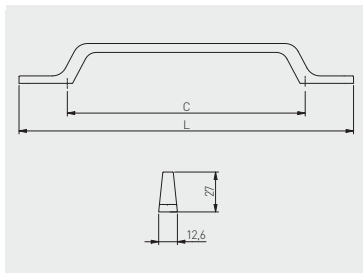

Uchwyt FLAVIO
Handle FLAVIO
Ручка FLAVIO

NEW







 C mm		 L mm					
		chrom chrome хром	stal szczotkowana brushed steel шлифованная сталь	złoty mosiądz golden brass золотая латунь	czarny mat black matt чёрный матовый	ZnAl	
96	161	UZ-FLAVIO-96-01	UZ-FLAVIO-96-06	UZ-FLAVIO-96-16	UZ-FLAVIO-96-20M		
128	193	UZ-FLAVIO-128-01	UZ-FLAVIO-128-06	UZ-FLAVIO-128-16	UZ-FLAVIO-128-20M		
160	225	UZ-FLAVIO-160-01	UZ-FLAVIO-160-06	UZ-FLAVIO-160-16	UZ-FLAVIO-160-20M		

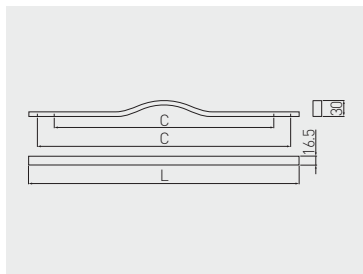



Uchwyt DOPPIO
Handle DOPPIO
Ручка DOPPIO

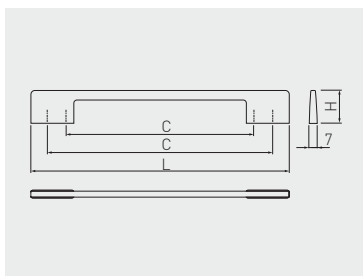

 C mm	 L mm		
192 / 224	256	chrom / aluminium chrome / aluminium хром / алюминий	aluminium aluminium алюминий
416 / 480	512	UA-DOPPIO192-01 UA-DOPPIO416-01	

Uchwyt THIN
Handle THIN
Ручка THIN





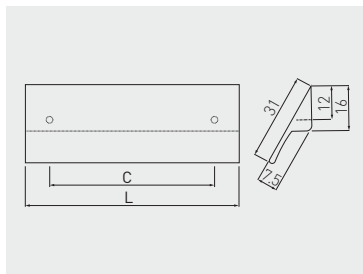

 C mm	 L mm	 H mm					
96/128	156	24	chrom chrome хром	satyna satin сатин	aluminium aluminium алюминий	stal szczotkowana brushed steel шлифованная сталь	ZnAl
160/192	220	28	UZ-TH096128-01	UZ-TH096128-02*	UZ-TH096128-05	UZ-TH096128-06	
288/320	348	28	UZ-TH160192-01	UZ-TH160192-02*	UZ-TH160192-05	UZ-TH160192-06	
			UZ-TH288320-01	UZ-TH288320-02*	UZ-TH288320-05	UZ-TH288320-06	

* Produkt dostępny na indywidualne zamówienie / Available for special orders / Товар доступен под заказ





Uchwyt PICCOLO
Handle PICCOLO
Ручка PICCOLO



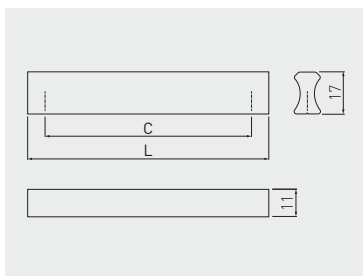



 C mm	 L mm		
		aluminium aluminium алюминий	aluminium aluminium алюминий
64	80	UA-PICCO-64-05	
128	145	UA-PICCO-128-05	
224	240	UA-PICCO-224-05	

Uchwyt ALFA
Handle ALFA
Ручка ALFA









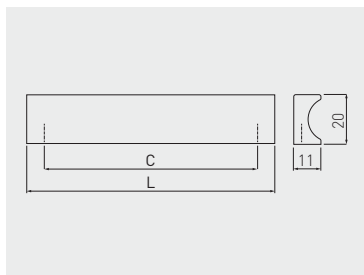

 C mm	 L mm		
		aluminium aluminium алюминий	aluminium aluminium алюминий
32	46	UA-ALFA-32-05	
96	110	UA-ALFA-96-05	
128	142	UA-ALFA-128-05	
160	174	UA-ALFA-160-05	
192	206	UA-ALFA-192-05	

 C mm	 L mm		
		aluminium aluminium алюминий	aluminium aluminium алюминий
224	238	UA-ALFA-224-05	
256	270	UA-ALFA-256-05	
288	302	UA-ALFA-288-05	
320	334	UA-ALFA-320-05	

Uchwył BETA
Handle BETA
Ручка BETA









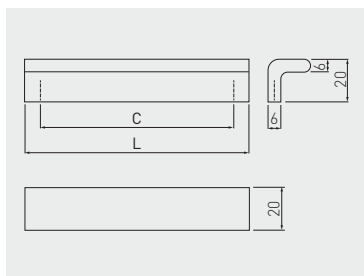

 C mm	 L mm		
96	110	aluminium aluminium алюминий	aluminium aluminium алюминий
128	142	UA-BETA-128-05	
160	174	UA-BETA-160-05	
192	206	UA-BETA-192-05	

 C mm	 L mm		
224	238	aluminium aluminium алюминий	aluminium aluminium алюминий
256	270	UA-BETA-224-05	
288	302	UA-BETA-256-05	
320	334	UA-BETA-288-05	
		UA-BETA-320-05	

Uchwył GAMMA
Handle GAMMA
Ручка GAMMA



 C mm	 L mm		
96	110	aluminium aluminium алюминий	aluminium aluminium алюминий
128	142	UA-GAMMA-96-05	
160	174	UA-GAMMA-128-05	
192	206	UA-GAMMA-160-05	

 C mm	 L mm		
224	238	aluminium aluminium алюминий	aluminium aluminium алюминий
256	270	UA-GAMMA-224-05	
288	302	UA-GAMMA-256-05	
320	334	UA-GAMMA-288-05	
		UA-GAMMA-320-05	

Uchwyt DELTA
Handle DELTA
Ручка DELTA

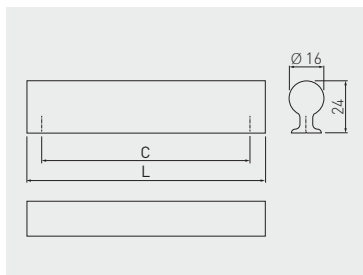

C mm	L mm		
96	110	aluminium aluminium алюминий	aluminium aluminium алюминий
128	142	UA-DELTA-128-05	
160	174	UA-DELTA-160-05	
192	206	UA-DELTA-192-05	

C mm	L mm		
224	238	aluminium aluminium алюминий	aluminium aluminium алюминий
256	270	UA-DELTA-224-05	
288	302	UA-DELTA-256-05	
320	334	UA-DELTA-288-05	
		UA-DELTA-320-05	



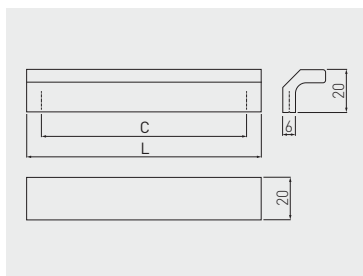

Uchwyt SIGMA
Handle SIGMA
Ручка SIGMA

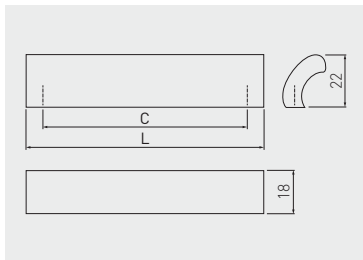

C mm	L mm		
		aluminium aluminium алюминий	aluminium aluminium алюминий
96	110	UA-SIGMA-96-05	
128	142	UA-SIGMA-128-05	
160	174	UA-SIGMA-160-05	
192	206	UA-SIGMA-192-05	
224	238	UA-SIGMA-224-05	
256	270	UA-SIGMA-256-05	
288	302	UA-SIGMA-288-05	
320	334	UA-SIGMA-320-05	





Uchwyt KAPPA
Handle KAPPA
Ручка KAPPA

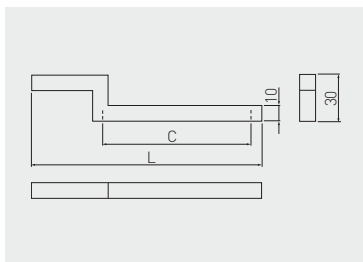

 C mm	 L mm		
		aluminium aluminium алюминий	aluminium aluminium алюминий
96	110	UA-KAPPA-96-05	
128	142	UA-KAPPA-128-05	
160	174	UA-KAPPA-160-05	
192	206	UA-KAPPA-192-05	
224	238	UA-KAPPA-224-05	
256	270	UA-KAPPA-256-05	
288	302	UA-KAPPA-288-05	
320	334	UA-KAPPA-320-05	

Uchwyt ALRA*
Handle ALRA*
Ручка ALRA*



 C mm	 L mm		
		chrom chrome хром	stal szcztkowana brushed steel шлифованная сталь
96	149	UZ-ALRA096-01	UZ-ALRA096-06

ZnAl

* Produkt dostępny na indywidualne zamówienie / Available for special orders / Товар доступен под заказ

Uchwyt UA-337
Handle UA-337
Ручка UA-337

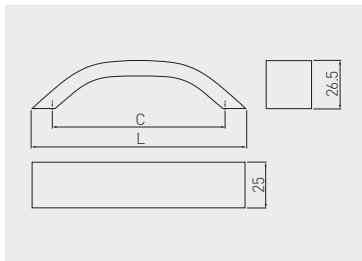

C mm	L mm			
		aluminium aluminium алюминий	czarny black чёрный	aluminium aluminium алюминий
96	116	UA-00-337096	UA-00-337096-20M	
128	146	UA-00-337128	UA-00-337128-20M	
160	180	UA-00-337160	UA-00-337160-20M	
192	212	UA-00-337192	UA-00-337192-20M	
224	244	UA-00-337224	UA-00-337224-20M	
256	275	UA-00-337256	UA-00-337256-20M	
320	340	UA-00-337320	UA-00-337320-20M	

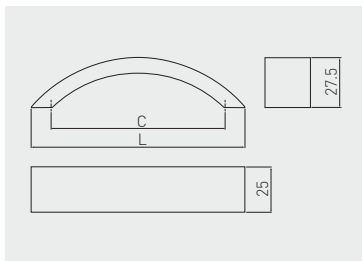

Uchwyt UA-338
Handle UA-338
Ручка UA-338

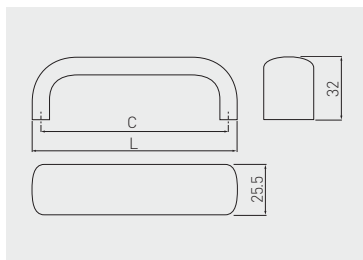

C mm	L mm			
		aluminium aluminium алюминий	aluminium aluminium алюминий	
128	137	UA-00-338128		
160	169	UA-00-338160		

Uchwyt UA-340
Handle UA-340
Ручка UA-340



C mm	L mm			
				aluminium aluminium алюминий
128	137			UA-00-340128
160	169			UA-00-340160
192	201			UA-00-340192
224	233			UA-00-340224
256	265			UA-00-340256
320	329			UA-00-340320

Uchwyt UA-347
Handle UA-347
Ручка UA-347

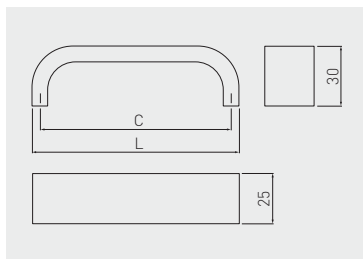

C mm	L mm			
				aluminium aluminium алюминий
128	136			UA-00-347128
160	168			UA-00-347160
192	200			UA-00-347192
224	232			UA-00-347224
256	264			UA-00-347256
320	328			UA-00-347320

Uchwyt CALABRIA
Handle CALABRIA
Ручка CALABRIA

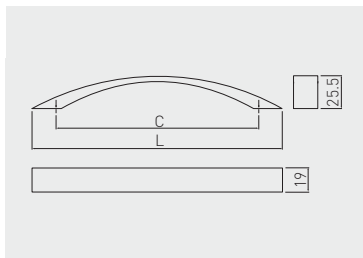

C mm	L mm			
		chrom chrome хром	stal szczotkowana brushed steel шлифованная сталь	ZnAl
160	195	UZ-CALABRIA160-01	UZ-CALABRIA160-06	
192	224	UZ-CALABRIA192-01	UZ-CALABRIA192-06	
224	258	UZ-CALABRIA224-01	UZ-CALABRIA224-06	

Uchwyt GENUA
Handle GENUA
Ручка GENUA

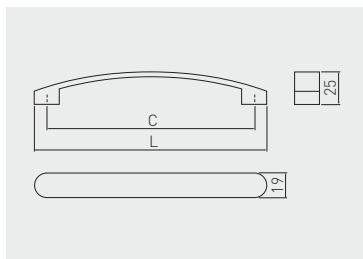



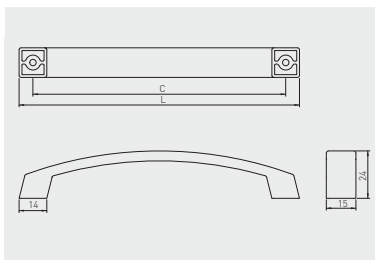

C mm	L mm				
		chrom chrome хром	satyna satin сатин	aluminium aluminium алюминий	ZnAl
128	148	UZ-GENUA128-01	UZ-GENUA128-02	UZ-GENUA128-05	
160	180	UZ-GENUA160-01	UZ-GENUA160-02	UZ-GENUA160-05	

Uchwyt G0
Handle G0
Ручка G0

NEW



 C mm	 L mm				
		chrom chrome хром	aluminium aluminium алюминий	stal szczotkowana brushed steel шлифованная сталь	ZnAl
128	142	UZ-G0-128-01	UZ-G0-128-05	UZ-G0-128-06	
160	174	UZ-G0-160-01	UZ-G0-160-05	UZ-G0-160-06	
192	206	UZ-G0-192-01	UZ-G0-192-05	UZ-G0-192-06	
256	270	UZ-G0-256-01	UZ-G0-256-05	UZ-G0-256-06	



Uchwyt UZ-G1
Handle UZ-G1
Ручка UZ-G1

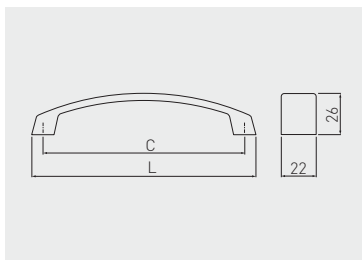

C mm	L mm	chrom chrome хром	aluminium aluminium алюминий	stal szczerkowana brushed steel шлифованная сталь	tytan titanium титан	ZnAl
128	142	UZ-G1-128-01	UZ-G1-128-05	UZ-G1-128-06	UZ-G1-128-13	
160	174	UZ-G1-160-01	UZ-G1-160-05	UZ-G1-160-06	UZ-G1-160-13	
192	206	UZ-G1-192-01	UZ-G1-192-05	UZ-G1-192-06	UZ-G1-192-13	
256	270	UZ-G1-256-01	UZ-G1-256-05	UZ-G1-256-06	UZ-G1-256-13	
320	334	UZ-G1-320-01	UZ-G1-320-05	UZ-G1-320-06	UZ-G1-320-13	
416	430	UZ-G1-416-01	UZ-G1-416-05	UZ-G1-416-06	-	

Uchwyt UZ-01
Handle UZ-01
Ручка UZ-01

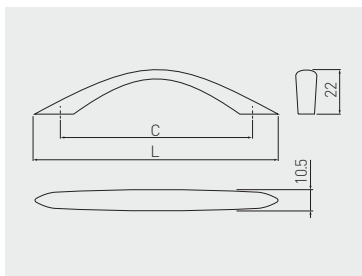

C mm	L mm	chrom chrome хром	satyna satin сатин	mosiądz brass латунь	aluminium aluminium алюминий	ZnAl
96	121	UZ-01-096-01	UZ-01-096-02	UZ-01-096-03	UZ-01-096-05	
128	158	UZ-01-128-01	UZ-01-128-02	UZ-01-128-03	UZ-01-128-05	

Uchwyt UZ-04
Handle UZ-04
Ручка UZ-04

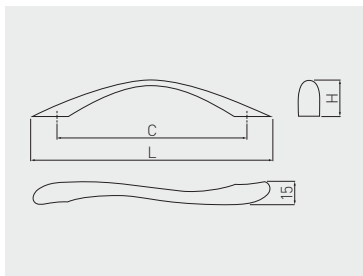

C mm	L mm	H mm	chrom chrome хром	satyna satin сатин	mosiądz brass латунь	aluminium aluminium алюминий	ZnAl
96	127	23	UZ-04-096-01	UZ-04-096-02	UZ-04-096-03	UZ-04-096-05	ZnAl
128	158	24	UZ-04-128-01	UZ-04-128-02	UZ-04-128-03	UZ-04-128-05	

Uchwyt UZ-05
Handle UZ-05
Ручка UZ-05

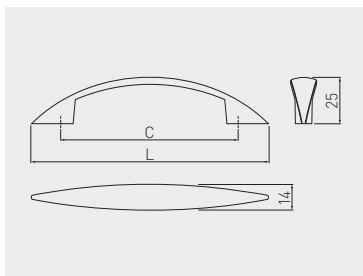

C mm	L mm	chrom chrome хром	satyna satin сатин	mosiądz brass латунь	aluminium aluminium алюминий	ZnAl
96	132	UZ-05-096-01	UZ-05-096-02	UZ-05-096-03	UZ-05-096-05	ZnAl
128	164	UZ-05-128-01	UZ-05-128-02	UZ-05-128-03	UZ-05-128-05	



Uchwyt UZ-06
Handle UZ-06
Ручка UZ-06

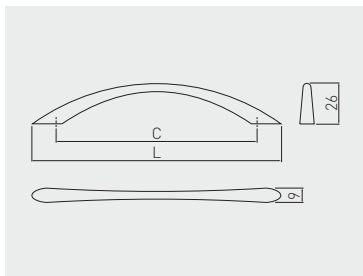

C
mm

L
mm



C	L	chrom chrome хром	satyna satin сатин	mosiądz brass латунь	aluminium aluminium алюминий	ZnAl
128	164	UZ-06-128-01	UZ-06-128-02	UZ-06-128-03	UZ-06-128-05	

Uchwyt UZ-07
Handle UZ-07
Ручка UZ-07

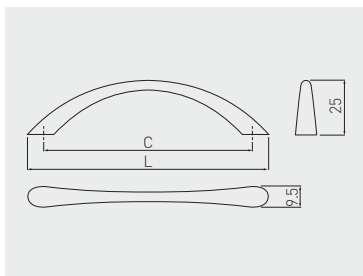

C
mm



L
mm

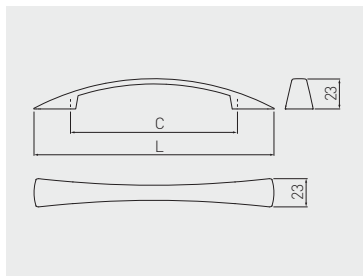

C	L	chrom chrome хром	satyna satin сатин	mosiądz brass латунь	aluminium aluminium алюминий	ZnAl
96	111	UZ-07-096-01	UZ-07-096-02	UZ-07-096-03	UZ-07-096-05	

Uchwyt UZ-Z10
Handle UZ-Z10
Ручка UZ-Z10



 C mm	 L mm					
		chrom chrome хром	satyna satin сатин	mosiądz brass латунь	aluminium aluminium алюминий	ZnAl
96	138	UZ-Z10096-01	UZ-Z10096-02	UZ-Z10096-03	UZ-Z10096-05	
128	184	UZ-Z10128-01	UZ-Z10128-02	UZ-Z10128-03	UZ-Z10128-05	

Uchwyt UZ-13
Handle UZ-13
Ручка UZ-13

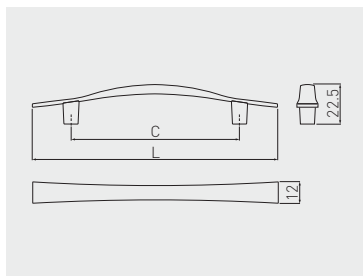

 C mm	 L mm					
		chrom chrome хром	satyna satin сатин	mosiądz brass латунь	aluminium aluminium алюминий	ZnAl
96	140	UZ-13-096-01	UZ-13-096-02	UZ-13-096-03	UZ-13-096-05	

Uchwył UZ-14
Handle UZ-14
Ручка UZ-14

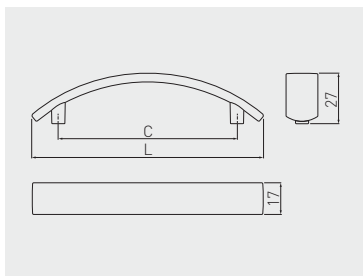

C mm	L mm					
		chrom chrome хром	satyna satin сатин	mosiadz brass латушь	aluminium aluminium алюминий	ZnAl
96	138	UZ-14-096-01	UZ-14-096-02	UZ-14-096-03	UZ-14-096-05	
128	184	UZ-14-128-01	UZ-14-128-02	UZ-14-128-03	UZ-14-128-05	

Uchwył CAMAIO
Handle CAMAIO
Ручка CAMAIO

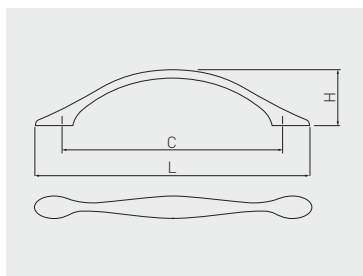

C mm	L mm	H mm				
			chrom chrome хром	satyna satin сатин	stal szcztokowana brushed steel шлифованная сталь	antyczny mosiadz szcztokowany antique brushed brass античная шлифованная латушь
96	126	23	UZ-CAMAI-96-01	UZ-CAMAI-96-02	UZ-CAMAI-96-06	UZ-CAMAI-96-09
128	160	32,5	UZ-CAMAI-128-01	UZ-CAMAI-128-02	UZ-CAMAI-128-06	UZ-CAMAI-128-09

C mm	L mm	H mm				
			biały mat white matt белый матовый	czarny mat black matt чёрный матовый	czarny chrom black chrome чёрный хром	ZnAl
96	126	23	UZ-CAMAI-96-10M	UZ-CAMAI-96-20M	UZ-CAMAI-96-12	
128	160	32,5	UZ-CAMAI-128-10M	UZ-CAMAI-128-20M	UZ-CAMAI-128-12	

Gatka BERGAMO
Knob BERGAMO
Ручка BERGAMO

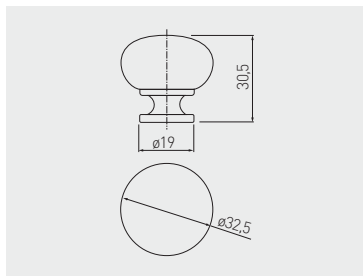

	chrom chrome хром	satyna satin сатин	aluminium aluminium алюминий	stal szczotkowana brushed steel шлифованная сталь	stal steel сталь
gatka knob ручка	GS-BERGA-1-01	GS-BERGA-1-02	GS-BERGA-1-05	GS-BERGA-1-06	



	biały white белый	czarny mat black matt чёрный матовый	czarny chrom black chrome чёрный хром	stal steel сталь
gatka knob ручка	GS-BERGA-1-10	GS-BERGA-1-20M	GS-BERGA-1-12	

Gatka UDINE
Knob UDINE
Ручка UDINE

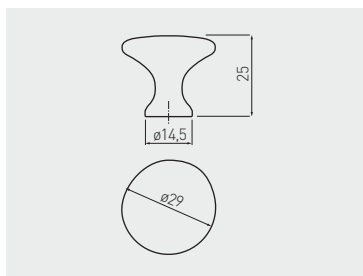

	chrom chrome хром	satyna satin сатин	aluminium aluminium алюминий	stal szczotkowana brushed steel шлифованная сталь	ZnAl
gatka knob ручка	GZ-UDINE-1-01	GZ-UDINE-1-02	GZ-UDINE-1-05	GZ-UDINE-1-06	



	biały mat white matt белый матовый	czarny mat black matt чёрный матовый	czarny chrom black chrome чёрный хром	ZnAl
gatka knob ручка	GZ-UDINE-1-10M	GZ-UDINE-1-20M	GZ-UDINE-1-12	

Gatka TERNI
Knob TERNI
Ручка TERNI

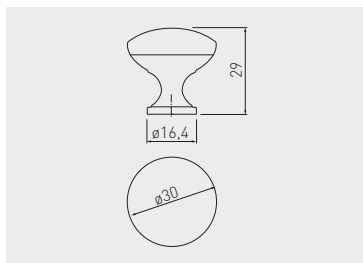

	chrom chrome хром	satyna satin сатин	aluminium aluminium алюминий	stal szcztokowana brushed steel шлифованная сталь	antyczny miedziany szcztokowany antique brushed brass античная шлифованная латунь
gatka knob ручка	GZ-TERNI-1-01	GZ-TERNI-1-02	GZ-TERNI-1-05	GZ-TERNI-1-06	GZ-TERNI-1-09



	biały white белый	czarny mat black matt чёрный матовый	czarny chrom black chrome чёрный хром	ZnAl
gatka knob ручка	GZ-TERNI-1-10	GZ-TERNI-1-20M	GZ-TERNI-1-12	

Gatka GZ-1155
Knob GZ-1155
Ручка GZ-1155

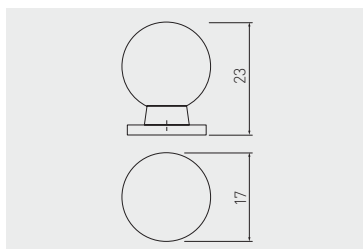

	chrom chrome хром	ZnAl
gatka knob ручка	GZ-WP1155-01	

Uchwyt US-C1*
Handle US-C1*
Ручка US-C1*

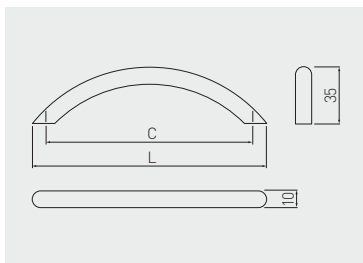

C mm	L mm		
96	111	stal szorstkowana brushed steel шлифованная сталь	stal steel сталь
128	145	US-C1-096-06	
		US-C1-128-06	

* Produkt dostępny na indywidualne zamówienie / Available for special orders / Товар доступен под заказ

Uchwyt US-C7*
Handle US-C7*
Ручка US-C7*

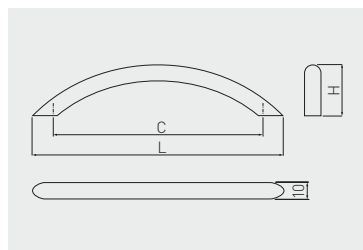

C mm	L mm	H mm		
96	119	31	chrom chrome хром	stal szorstkowana brushed steel шлифованная сталь
128	153		US-C7-096-01	US-C7-096-06
160	188		US-C7-128-01	US-C7-128-06
192	227		US-C7-160-01	US-C7-160-06
224	253		US-C7-192-01	US-C7-192-06
256	289		US-C7-224-01	US-C7-224-06
288	325	34	US-C7-256-01	US-C7-256-06
320	359		US-C7-288-01	US-C7-288-06
352	406		US-C7-320-01	US-C7-320-06
			US-C7-352-01	US-C7-352-06

* Produkt dostępny na indywidualne zamówienie / Available for special orders / Товар доступен под заказ

Gatka GZ-ZH
Knob GZ-ZH
Ручка GZ-ZH

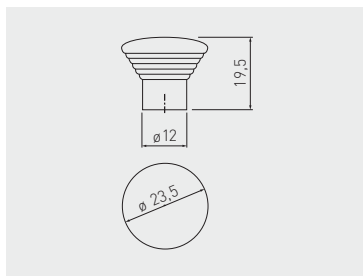

	 C mm		
	chrom chrome хром	stal szczotkowana brushed steel шлифованная сталь	ZnAl
gatka knob ручка	GZ-ZH-011-01A	GZ-ZH-011-06A	

Uchwyt UZ-19
Handle UZ-19
Ручка UZ-19

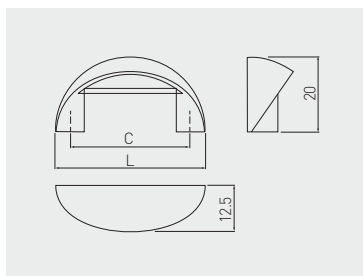

	 C mm	 L mm		
			satyna satin сатин	stal szczotkowana brushed steel шлифованная сталь
	32	40	UZ-19-032-01	UZ-19-032-02
				UZ-19-032-06
				ZnAl

Uchwyt US-U4*
Handle US-U4*
Ручка US-U4*

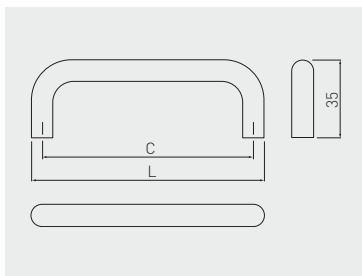

C mm	L mm			
		chrom chrome хром	stal szczotkowana brushed steel шлифованная сталь	
64	74	US-U4-064-01	US-U4-064-06	stal steel сталь
96	106	US-U4-096-01	US-U4-096-06	
128	138	US-U4-128-01	US-U4-128-06	
160	170	US-U4-160-01	US-U4-160-06	
192	202	US-U4-192-01	US-U4-192-06	
320	330	US-U4-320-01	US-U4-320-06	

* Produkt dostępny na indywidualne zamówienie / Available for special orders / Товар доступен под заказ

Uchwyt UZ-605
Handle UZ-605
Ручка UZ-605

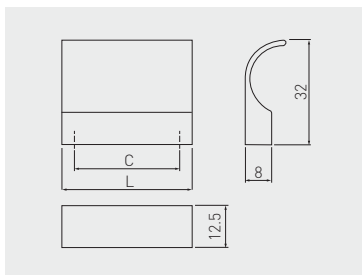

C mm	L mm			
		chrom chrome хром	aluminium aluminium алюминий	
32	40	UZ-605032-01	UZ-605032-05	ZnAl

Uchwyt TRIEST
Handle TRIEST
Ручка TRIEST

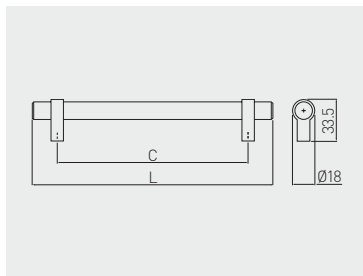

C mm	L mm		
		stal szczotkowana brushed steel шлифованная сталь	
96	136	RS-TRIES-96-06	stal, ZnAl steel, ZnAl сталь, ZnAl
128	168	RS-TRIES-128-06	
160	200	RS-TRIES-160-06	
192	232	RS-TRIES-192-06	
256	296	RS-TRIES-256-06	
320	360	RS-TRIES-320-06	



Uchwyt RELING RS
Handle RELING RS
Ручка RELING RS

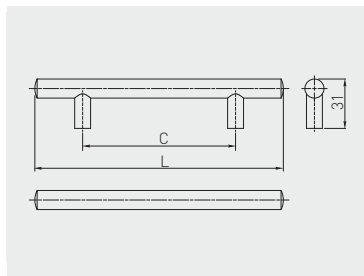

C mm	L mm	chrom chrome хром	satyna satin сатин	aluminium aluminium алюминий	stal szcztokowana brushed steel шлифованная сталь	antyczna miedź antique copper античная медь	
96	156	RS-156096-01	RS-156096-02	RS-156096-05	RS-156096-06	RS-156096-14	
128	188	RS-188128-01	RS-188128-02	RS-188128-05	RS-188128-06	RS-188128-14	
160	220	RS-220160-01	RS-220160-02	RS-220160-05	RS-220160-06	RS-220160-14	
192	272	RS-272192-01	RS-272192-02	RS-272192-05	RS-272192-06	RS-272192-14	
224	304	RS-304224-01	RS-304224-02	RS-304224-05	RS-304224-06	RS-304224-14	
256	336	RS-336256-01	RS-336256-02	RS-336256-05	RS-336256-06	RS-336256-14	
288	368	RS-368288-01	RS-368288-02	RS-368288-05	RS-368288-06	-	stal steel сталь
320	400	RS-400320-01	RS-400320-02	RS-400320-05	RS-400320-06	RS-400320-14	
352	432	RS-432352-01	RS-432352-02	RS-432352-05	RS-432352-06	-	
384	464	RS-464384-01	RS-464384-02	RS-464384-05	RS-464384-06	-	
416	496	RS-496416-01	RS-496416-02	RS-496416-05	RS-496416-06	-	
448	528	RS-528448-01	RS-528448-02	RS-528448-05	RS-528448-06	-	
480	560	RS-560480-01	RS-560480-02	RS-560480-05	RS-560480-06	-	
512	592	RS-592512-01	RS-592512-02	RS-592512-05	RS-592512-06	-	
544	624	RS-624544-01	RS-624544-02	RS-624544-05	RS-624544-06	-	

Na indywidualne zamówienie dostępne również rozstawy: 576, 608, 640, 672, 704, 736, 768, 800 [mm].

Other sizes are available for special orders: 576, 608, 640, 672, 704, 736, 768, 800 [mm].

Под заказ доступны ручки с межцентровым расстоянием: 576, 608, 640, 672, 704, 736, 768, 800 [мм]



antyczna miedź
antique copper
античная медь

Uchwyt UA-326
Handle UA-326
Ручка UA-326

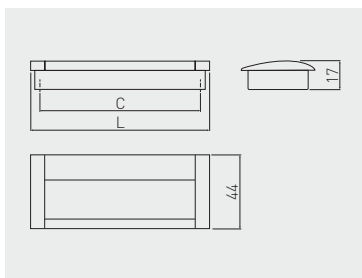

C mm	L mm					
96	108	aluminium / chrom aluminium / chrome алюминий / хром	aluminium aluminium алюминий	czarny black чёрный	aluminium aluminium алюминий	
128	140	UA-01-326128-V1	UA-00-326128	UA-00-326128-20M		
160	172	UA-01-326160	*	UA-00-326160-20M		

* Produkt dostępny na indywidualne zamówienie / Available for special orders / Товар доступен под заказ

Uchwyt UZ-E6
Handle UZ-E6
Ручка UZ-E6

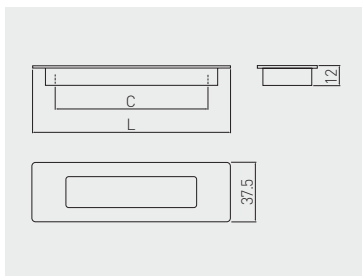

C mm	L mm					
96	124	chrom chrome хром	aluminium aluminium алюминий	stal szorstkowana brushed steel шлифованная сталь	ZnAl	
128	155	UZ-E6-128-01	UZ-E6-128-05	UZ-E6-128-06		
160	186	UZ-E6-160-01	UZ-E6-160-05	UZ-E6-160-06		

Uchwyt B224
Handle B224
Ручка B224

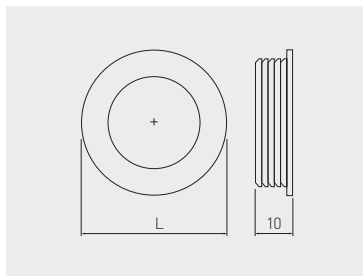

L mm	chrom chrome хром	satyna satin сатин	aluminium aluminium алюминий	biały white белый	czarny black чёрный	ZnAl
40,5	UZ-00B224-01	UZ-00B224-02	UZ-00B224-05	UZ-00B224-10	UZ-00B224-20	

Uchwyt B226
Handle B226
Ручка B226

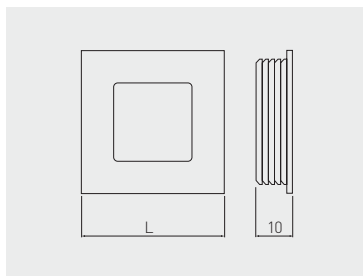

L mm	chrom chrome хром	satyna satin сатин	aluminium aluminium алюминий	biały white белый	czarny black чёрный	ZnAl
40	UZ-00B226-01	UZ-00B226-02	UZ-00B226-05	UZ-00B226-10	UZ-00B226-20	

Uchwyt UZ-R132
Handle UZ-R132
Ручка UZ-R132

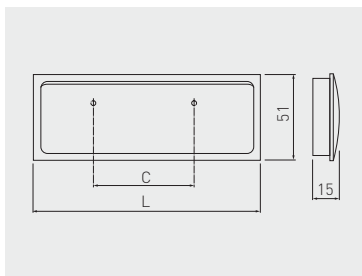

 C mm	 L mm				
64	133	chrom chrome хром	satyna satin сатин	stal szorstkowana brushed steel шлифованная сталь	ZnAl
		UZ-R132-A1-01	UZ-R132-A1-02	UZ-R132-A1-06	

Uchwyt UZ-S50
Handle UZ-S50
Ручка UZ-S50

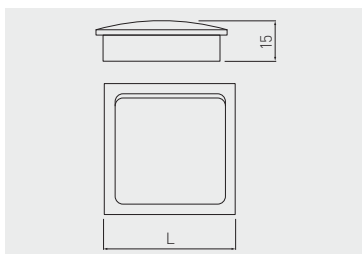

 L mm					
50	chrom chrome хром	satyna satin сатин	aluminium aluminium алюминий	stal szorstkowana brushed steel шлифованная сталь	ZnAl
	UZ-S50-A1-01	UZ-S50-A1-02	UZ-S50-A1-05	UZ-S50-A1-06	

Uchwyt HEXI
Handle HEXI
Ручка HEXI

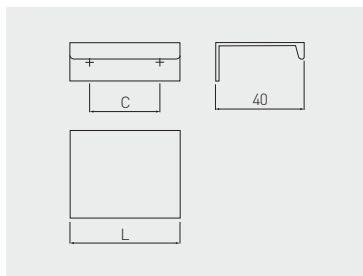

C
mm

L
mm



C mm	L mm	chrom chrome хром	aluminium aluminium алюминий	biały mat white matt белый матовый	czarny mat black matt чёрный матовый	aluminium aluminium алюминий
32	50	UA-HEXI-01	UA-HEXI-05	UA-HEXI-10M	UA-HEXI-20M	
96	150	UA-HEXI96-01	UA-HEXI96-05	UA-HEXI96-10M	UA-HEXI96-20M	
192	225	UA-HEXI192-01	UA-HEXI192-05	UA-HEXI192-10M	UA-HEXI192-20M	
do cięcia to cut для резки	3500	-	UA-HEXI-3500-05	-	-	

Uchwyt PAXO
Handle PAXO
Ручка PAXO

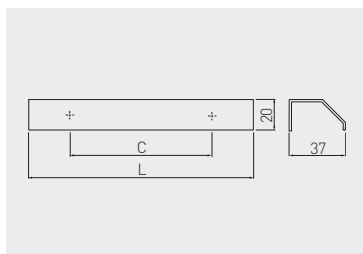

C
mm

L
mm



C mm	L mm	aluminium aluminium алюминий	aluminium aluminium алюминий
32	50	UA-PAXO-32-50-05	
96	150	UA-PAXO-96-150-05	
224	250	UA-PAXO-224-250-05	
320	350	UA-PAXO-320-350-05	
do cięcia to cut для резки	3500	UA-PAXO-3500-05	

Uchwyt TREX
Handle TREX
Ручка TREX

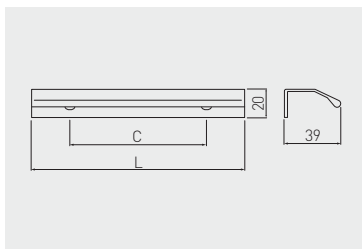

C mm	L mm			
		aluminium aluminium алюминий	czarny mat black matt чёрный матовый	
32	50	UA-TREX-32-50-05	UA-TREX-32-50-20M	aluminium aluminium алюминий
96	150	UA-TREX-96-150-05	UA-TREX-96-150-20M	
224	250	UA-TREX-224-250-05	UA-TREX-224-250-20M	
320	350	UA-TREX-320-350-05	UA-TREX-320-350-20M	
do cięcia to cut для резки	3500	UA-TREX-3500-05	-	

Uchwyt PROFIL C
Handle PROFIL C
Ручка PROFIL C

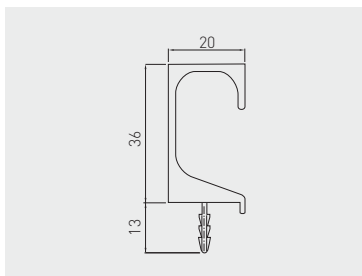

C mm	L mm			
		aluminium aluminium алюминий		aluminium aluminium алюминий
do cięcia to cut для резки	3500	PA-0242-35-50		

Uchwyt PROFIL L
Handle PROFIL L
Ручка PROFIL L

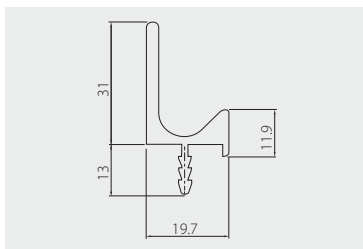

C mm	L mm		
do cięcia to cut для резки	3500	aluminium aluminium алюминий	aluminium aluminium алюминий
		PA-0243-35-50	



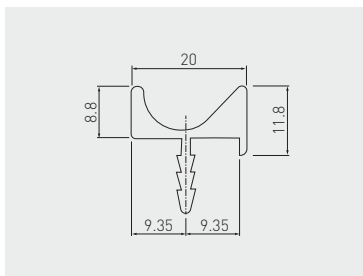

Uchwyt PROFIL U
Handle PROFIL U
Ручка PROFIL U

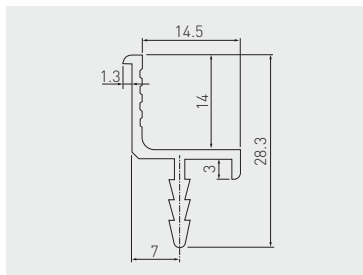

C mm	L mm		
do cięcia to cut для резки	3500	aluminium aluminium алюминий	aluminium aluminium алюминий
		PA-0244-35-50	

Uchwyt PROFIL J
Handle PROFIL J
Ручка PROFIL J



 C mm	 L mm		
do cięcia to cut для резки	3500	aluminium aluminium алюминий	aluminium aluminium алюминий
		PA-0245-35-50	

Uchwyt PROFIL C2
Handle PROFIL C2
Ручка PROFIL C2

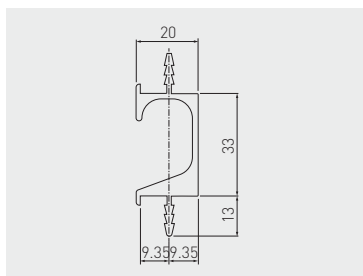

 C mm	 L mm		
do cięcia to cut для резки	3500	aluminium aluminium алюминий	aluminium aluminium алюминий
		PA-0241-35-50	

Uchwyt METRON
Handle METRON
Ручка METRON

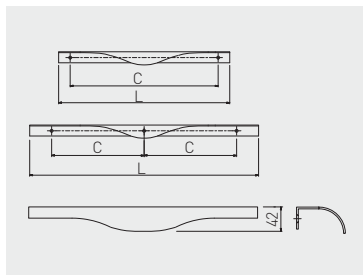

C
mm

L
mm



C mm	L mm	chrom chrome хром	aluminium aluminium алюминий	aluminium aluminium алюминий
256	296	UA-METRO-256-296-18-01	UA-METRO-256-296-18-05	
320	396	UA-METRO-320-396-18-01	UA-METRO-320-396-18-05	
2 x 224*	496	UA-METRO-224-496-18-01	UA-METRO-224-496-18-05	
2 x 256*	596	UA-METRO-256-596-18-01	UA-METRO-256-596-18-05	
2 x 352*	796	UA-METRO-352-796-18-01	UA-METRO-352-796-18-05	

* Mocowanie na 3 wkręty / Mounted with 3 screws / Крепление на 3 самореза

Uchwyt PICADO
Handle PICADO
Ручка PICADO

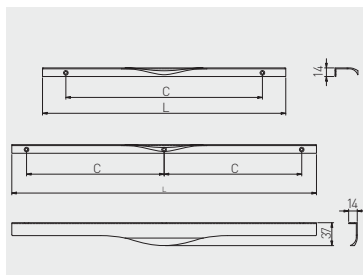

C
mm

L
mm



C mm	L mm	czarny mat black matt чёрный матовый	aluminium aluminium алюминий
256	296	UA-PICADO-256-296-20M	aluminium aluminium алюминий
320	396	UA-PICADO-320-396-20M	
2 x 224*	496	UA-PICADO-224-496-20M	
2 x 256*	596	UA-PICADO-256-596-20M	
2 x 352*	796	UA-PICADO-352-796-20M	

* Mocowanie na 3 wkręty / Mounted with 3 screws / Крепление на 3 самореза

Gatka J4
Knob J4
Ручка J4

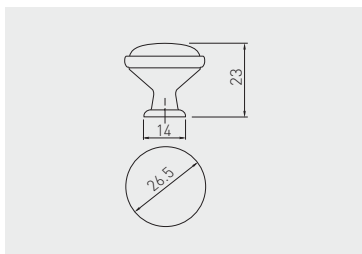

motyw pattern рисунок	antyczny mosiądz antique brass античная латунь	antyczne srebro antique silver старинное серебро	ZnAl, porcelana ZnAl, porcelain ZnAl, фарфор
autumn rose	GP-0728-J4-B	-	
spring flower	GP-0728-J4-R	-	
blue rose	GP-0728-J4-A-04	GP-0728-J4-A-07	
orient gold	GP-0728-J4-C-04	-	



autumn rose



spring flower



blue rose



orient gold

Uchwyt 728B
Handle 728B
Ручка 728B

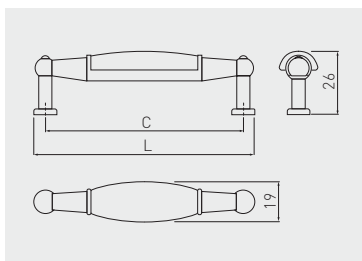

motyw pattern рисунок	C mm	L mm	antyczny mosiądz antique brass античная латунь	ZnAl, porcelana ZnAl, porcelain ZnAl, фарфор
spring flower	96	106	UP-WP0728-BR	
country	96	106	UP-WP0728-BK	
ornament	96	106	UP-WP0728-BX	
autumn rose	96	106	UP-WP0728-BB	



spring flower



country



ornament



autumn rose

Uchwyt 728P
Handle 728P
Ручка 728P

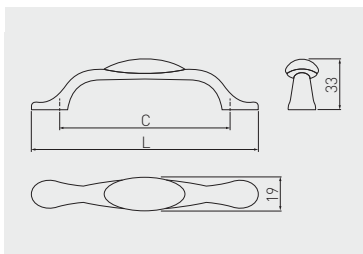

motyw pattern рисунок	C mm	L mm	antyczny mosiądz antique brass античная латунь	antyczne srebro antique silver старинное серебро	ZnAl, porcelana ZnAl, porcelain ZnAl, фарфор
blue rose	96	125	UP-WP0728-PA-04	UP-WP0728-PA-07	
orient gold	96	125	UP-WP0728-PC-04	-	
ornament	96	125	UP-WP0728-PX	-	
autumn rose	96	125	UP-WP0728-PB	-	
spring flower	96	125	UP-WP0728-PR	-	
country	96	125	UP-WP0728-PK	-	
milky	96	125	UP-WP0728-P0	-	



blue rose

orient gold

ornament

autumn rose

spring flower

country

milky

Uchwyt ALATRI
Handle ALATRI
Ручка ALATRI

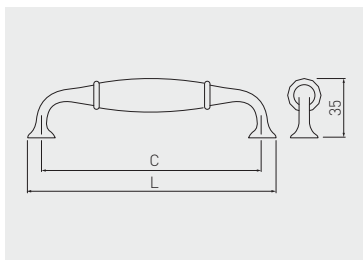

	C mm	L mm	antyczny mosiądz antique brass античная латунь	ZnAl, porcelana ZnAl, porcelain ZnAl, фарфор
128	144		UZ-ALATR-128-04	



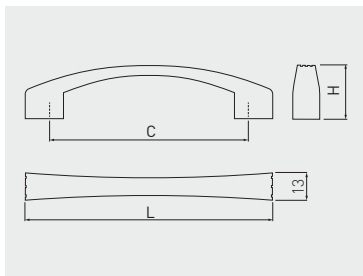



Uchwyt VASTO
Handle VASTO
Ручка VASTO

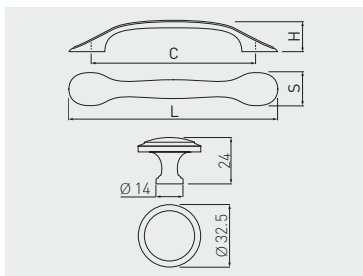

 C mm	 L mm	 H mm		
			antyczny mosiądz szczotkowany antique brushed brass античная шлифованная латунь	ZnAl
96	120	26	UZ-VASTO-96-09	
128	151	27	UZ-VASTO-128-09	

Uchwyt PALERMO
Handle PALERMO
Ручка PALERMO



 C mm	 L mm	 H mm	 S mm		
				antyczne srebro antique silver античное серебро	ZnAl
96	127	22.5	23	UZ-PALER-96-07	
128	159	23	25	UZ-PALER-128-07	
gatka knob ручка	-	-	-	GZ-PALER-1-07	

Uchwyt UZ-10
Handle UZ-10
Ручка UZ-10

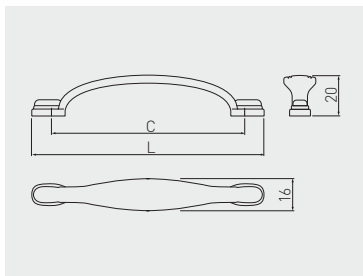

C mm	L mm		
96	120	antyczny mosiądz antique brass античная латунь	ZnAl
		UZ-10-096-N04	

Uchwyt UZ-12
Handle UZ-12
Ручка UZ-12

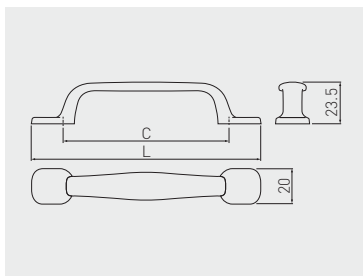

C mm	L mm				
96	131	antyczny mosiądz antique brass античная латунь	antyczne srebro antique silver античное серебро	czarny mat black matt чёрный матовый	ZnAl
		UZ-12-096-04	UZ-12-096-07	UZ-12-096-20M	

Uchwyt WERONA
Handle WERONA
Ручка WERONA

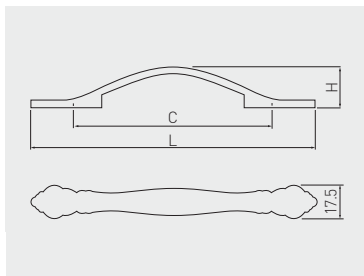

C mm	L mm	H mm				
			antyczny mosiądz antique brass античная латунь	antyczny mosiądz szczotkowany antique brushed brass античная шлифованная латунь	czarny chrom black chrome чёрный хром	ZnAl
96	148	24,5	UZ-WERON-96-04	UZ-WERON-96-09	UZ-WERON-96-12	
128	183	26,5	UZ-WERON-128-04	UZ-WERON-128-09	UZ-WERON-128-12	

Gatka ARDEA
Knob ARDEA
Ручка ARDEA

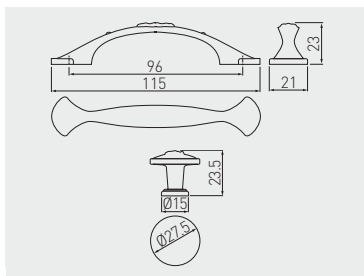

C mm	L mm		
		antyczny mosiądz antique brass античная латунь	ZnAl
96	115	UZ-ARDEA-96-09	
gatka knob ручка	-	GZ-ARDEA-1-09	



Uchwyt VINCENZA
Handle VINCENZA
Ручка VINCENZA

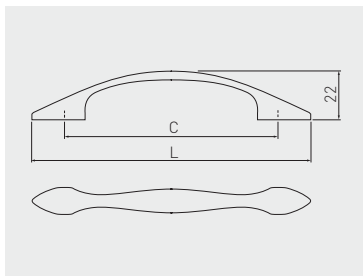

 C mm	 L mm		
96	125	antyczny mosiądz antique brass античная латунь	ZnAl
UZ-VINCE-96-04			

Uchwyt APRILLA
Handle APRILLA
Ручка APRILLA

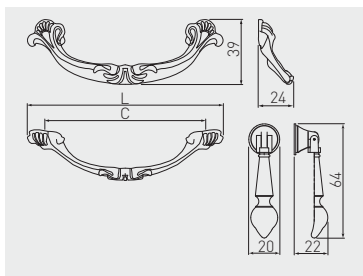

 C mm	 L mm		
96	122	antyczny mosiądz antique brass античная латунь	ZnAl
UZ-APRIL-96-04			
kołatka knocker ручка		KT-APRIL-1-04	

Uchwyt AVELI
Handle AVELI
Ручка AVELI

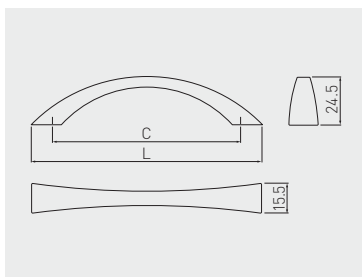

 C mm	 L mm		
96	118	antyczny mosiądz antique brass античная латунь	ZnAl
UZ-AVELI-96-04			

Uchwyt ARCHE*
Handle ARCHE*
Ручка ARCHE*

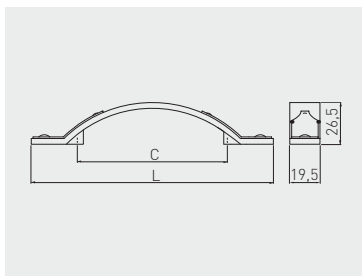

 C mm	 L mm		
96	155	antyczny mosiądz szczotkowany antique brushed brass античная шлифованная латунь	ZnAl
UZ-ARCH096-AEB			

* Produkt dostępny na indywidualne zamówienie / Available for special orders / Товар доступен под заказ

Uchwyt AREZO
Handle AREZO
Ручка AREZO

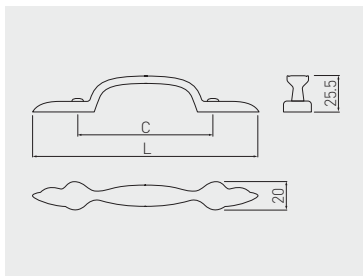

 C mm	 L mm		
96	160	antyczny mosiądz antique brass античная латунь	ZnAl
UZ-AREZO-96-04			

Uchwyt ABIATE
Handle ABIATE
Ручка ABIATE

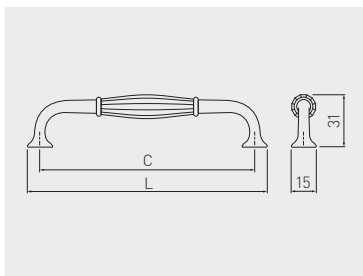

 C mm	 L mm		
128	143	antyczny mosiądz antique brass античная латунь	ZnAl
UZ-ABIAT-128-04			

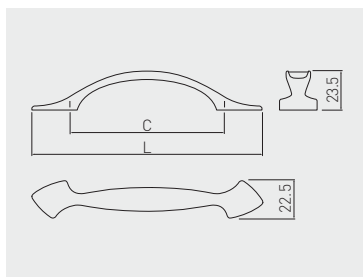

Uchwyt ADRIN
Handle ADRIN
Ручка ADRIN



 C mm	 L mm		
96	139	antyczny mosiądz antique brass античная латунь	ZnAl
UZ-ADRIN-96-04			

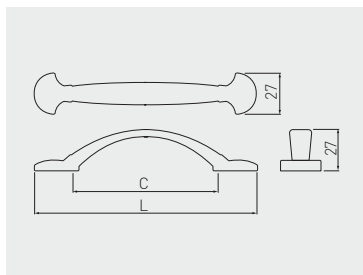



Uchwyt ACERA
Handle ACERA
Ручка ACERA

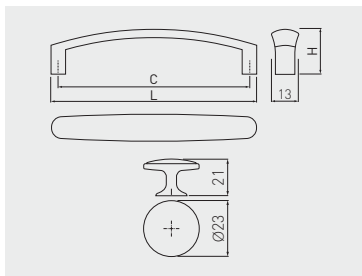

 C mm	 L mm		
96	147	antyczny mosiądz antique brass античная латунь	ZnAl
UZ-ACERA-96-04			

Uchwyt OLBIA
Handle OLBIA
Ручка OLBIA



 C mm	 L mm	 H mm		
96	103	22	antyczny mosiądz antique brass античная латунь	ZnAl
128	136	24	UZ-OLBIA-96-04	
128	136	24	UZ-OLBIA-128-04	
gałka knob ручка	-	-	GZ-OLBIA-1-04	

Uchwyt LATINA
Handle LATINA
Ручка LATINA

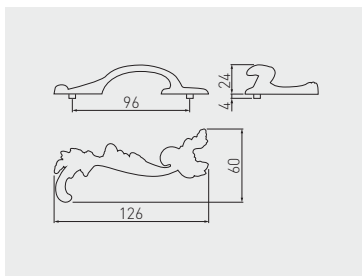

 C mm		
96	antyczny mosiądz antique brass античная латунь	ZnAl
96	UZ-LATIN-96-04	



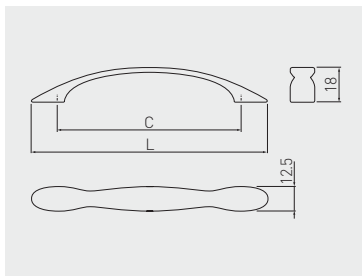

Uchwyt ANZIO
Handle ANZIO
Ручка ANZIO

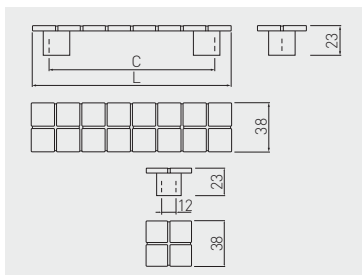

 C mm	 L mm		
96	123	antyczny mosiądz antique brass античная латунь	ZnAl
UZ-ANZIO-96-04			

Uchwyt AZTEK
Handle AZTEK
Ручка AZTEK



 C mm	 L mm		
128	155	antyczny mosiądz antique brass античная латунь	ZnAl
160	194	UZ-AZ-160-04	
gatka knob ручка	38	UZ-AZ-012-04	

Uchwyt MARSALA
Handle MARSALA
Ручка MARSALA

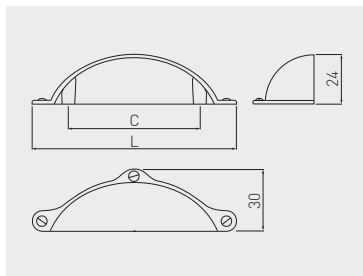

C mm	L mm				
64	99,5	antyczne srebro antique silver античное серебро	antyczny mosiądz szczotkowany antique brushed brass античная шлифованная латунь	biały mat white matt белый матовый	ZnAl
		UZ-MARSA-64-07	UZ-MARSA-64-09	UZ-MARSA-64-10M	
C mm	L mm				
64	99,5	tytan szczotkowany brushed titanium шлифованный титан	czarny mat black matt чёрный матовый		ZnAl
		UZ-MARSA-64-11	UZ-MARSA-64-20M		



Uchwyt ROYAL
Handle ROYAL
Ручка ROYAL

GZ-ROYAL3-1-10/03



UZ-ROYAL4-96-03



UZ-ROYAL1-96-10/03



UZ-ROYAL2-96-10/03



UZ-ROYAL3-96-10/03



UZ-ROYAL5-128-10/03

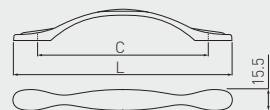
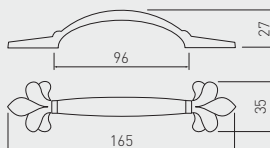
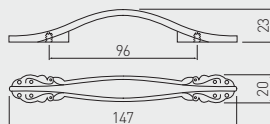
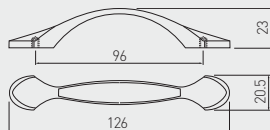
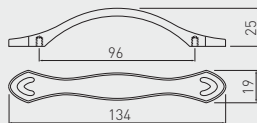
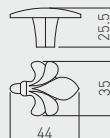

motyw pattern рисунок	C mm	L mm	biały / złoty white / gold белый / золото	
latina	96	126	UZ-ROYAL1-96-10/03	ZnAl
werona	96	147	UZ-ROYAL2-96-10/03	
genova	96	165	UZ-ROYAL3-96-10/03	
reggio	96	134	UZ-ROYAL4-96-03	
piano	96	131	UZ-ROYAL5-96-10-03	
	128	164	UZ-ROYAL5-128-10-03	
genova	gatka knob ручка	35	GZ-ROYAL3-1-10/03	

Gatka UZ-WP146
Knob UZ-WP146
Ручка UZ-WP146

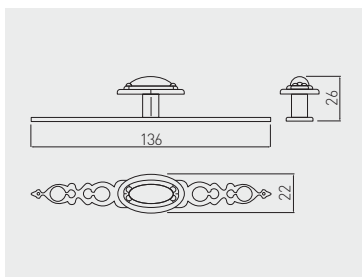

	 	
	antyczny mosiądz antique brass античная латунь	ZnAl
gatka knob ручка	UZ-WP1146-04	

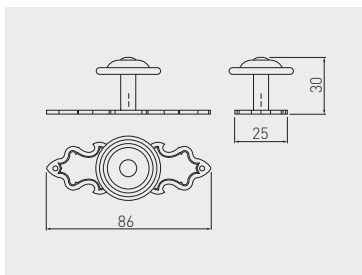

Gatka GZ-1136
Knob GZ-1136
Ручка GZ-1136

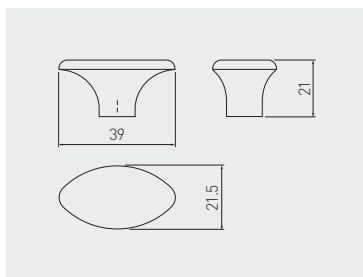

	 	
	antyczny mosiądz antique brass античная латунь	ZnAl
gatka knob ручка	GZ-WP1136-04	

Gatka GZ-1148
 Knob GZ-1148
 Ручка GZ-1148



	 
	antyczny mosiądz antique brass античная латунь
gatka knob ручка	GZ-WP1148-04
	ZnAl

Gatka GZ-1152*
 Knob GZ-1152*
 Ручка GZ-1152*

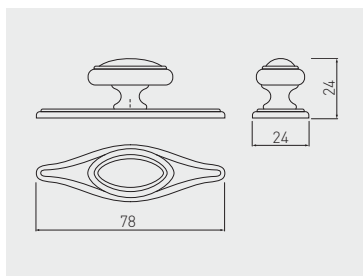

	 
	antyczny mosiądz antique brass античная латунь
gatka knob ручка	GZ-WP1152-04
	ZnAl

* Produkt dostępny na indywidualne zamówienie / Available for special orders / Товар доступен под заказ

Uchwyt RENNES
Handle RENNES
Ручка RENNES



C mm	L mm		
96	121	antyczny mosiądz antique brass античная латунь	ZnAl
kołatka knocker ручка		UZ-RENG02-04A	
gałka knob ручка		UZ-RENG01-04A	

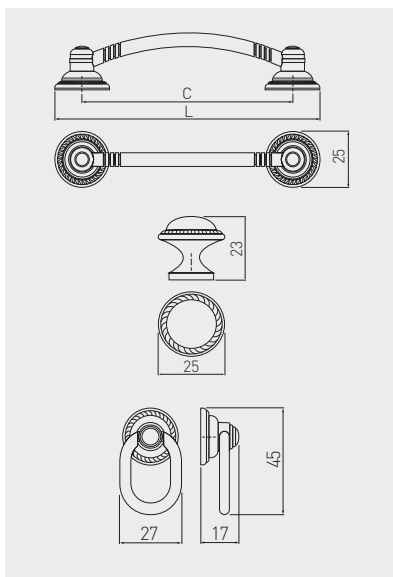

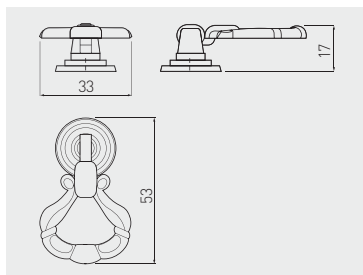

Kołatka KT-1147
Knocker KT-1147
Ручка KT-1147



		antyczny mosiądz antique brass античная латунь	ZnAl
kołatka knocker ручка	KT-WP1147-04		

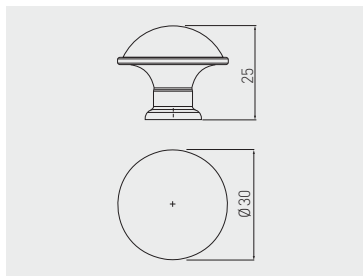



Gałka FROSINO
Knob FROSINO
Ручка FROSINO

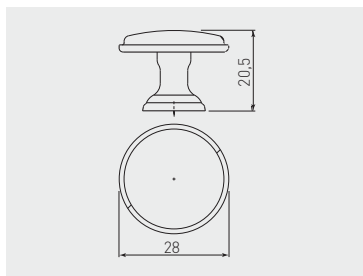

			
	antyczny mosiądz antique brass античная латунь	antyczny mosiądz szczotkowany antique brushed brass античная шлифованная латунь	ZnAl
gałka knob ручка	GZ-FROSI-1-04	GZ-FROSI-1-09	

Gałka CENTO
Knob CENTO
Ручка CENTO



					
	antyczny mosiądz antique brass античная латунь	antyczne srebro antique silver античное серебро	antyczna miedź antique copper античная медь	czarny mat black matt чёрный матовый	ZnAl
gałka knob ручка	GZ-CENTO-1-04	GZ-CENTO-1-07	GZ-CENTO-1-14	GZ-CENTO-1-20M	

Gatka IMPERIA
Knob IMPERIA
Ручка IMPERIA

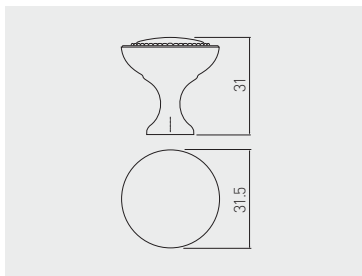





	satyna satin сатин	tytan szczotkowany brushed titanium шлифованный титан	czarny mat black matt чёрный матовый	aluminium aluminium алюминий
gatka knob ручка	GA-IMPER-1-02B	GA-IMPER-1-11	GA-IMPER-1-20M	

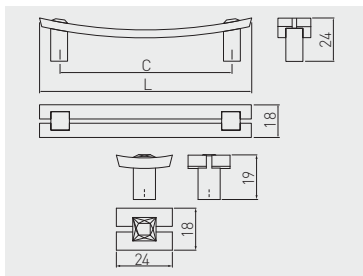





Uchwyt UZ-71C
Handle UZ-71C
Ручка UZ-71C

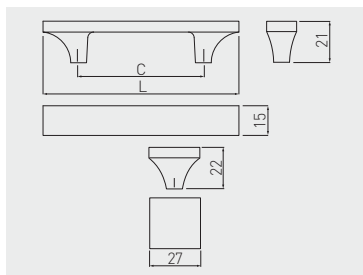

 C mm	 L mm		
		chrom chrome хром	ZnAl, szkło ZnAl, glass ZnAl, стекло
96	118	UZ-71C096-01	
gąłka knob ручка		GZ-71C024-01	

Uchwyt UZ-02C
Handle UZ-02C
Ручка UZ-02C





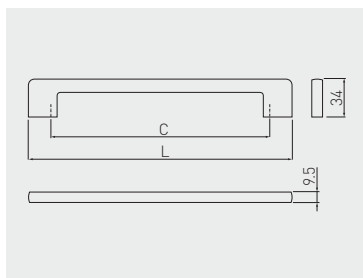

 C mm	 L mm		
		chrom chrome хром	ZnAl, szkło ZnAl, glass ZnAl, стекло
64	99	UZ-02C064-01	
96	135	UZ-02C096-01	
gąłka knob ручка	27	UZ-02CF27-01	

Uchwyt UZ-CRA14*
 Handle UZ-CRA14*
 Ручка UZ-CRA14*

GLAMOUR





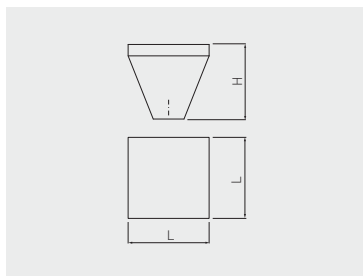

 C mm	 L mm		
		chrom chrome хром	ZnAl
128	166	UZ-CRA14-128	
192	230	UZ-CRA14-192	
320	358	UZ-CRA14-320	

* Produkt dostępny na indywidualne zamówienie / Available for special orders / Товар доступен под заказ

Gałka UZ-CR0*
 Knob UZ-CR0*
 Ручка UZ-CR0*





	 L mm	 H mm		
gałka knob ручка			chrom chrome хром	ZnAl
	30	28,5	UZ-CR0333-A1	
	25	23	UZ-CR0333-B1	

* Produkt dostępny na indywidualne zamówienie / Available for special orders / Товар доступен под заказ

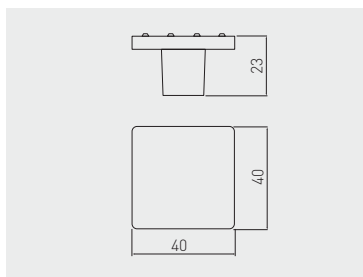
Gałka IZIS*
Knob IZIS*
Ручка IZIS*



	 L mm		
		chrom chrome хром	tytan szczotkowany brushed titanium шлифованный титан
gałka knob ручка	40	UZ-IZIS40-01	UZ-IZIS40-11
ZnAl			

* Produkt dostępny na indywidualne zamówienie / Available for special orders / Товар доступен под заказ

Uchwyt ERIS*
Handle ERIS*
Ручка ERIS*

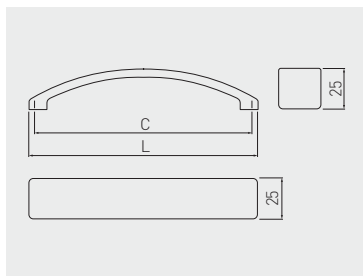



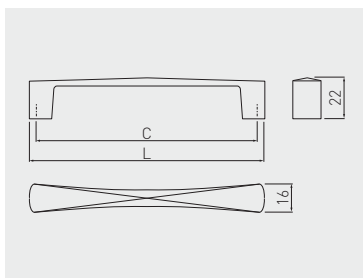

 C mm	 L mm		
		tytan szczotkowany brushed titanium шлифованный титан	ZnAl
128	142	UZ-ERIS128-11	

* Produkt dostępny na indywidualne zamówienie / Available for special orders / Товар доступен под заказ







Uchwyt COMO
Handle COMO
Ручка COMO

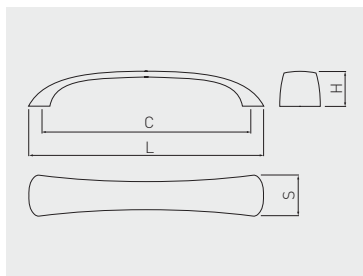

 C mm	 L mm		
		chrom chrome хром	ZnAl
96	104	UZ-COM0096-01	
128	135	UZ-COM0128-01	
160	170	UZ-COM0160-01	





Uchwyt SIENNA
Handle SIENNA
Ручка SIENNA

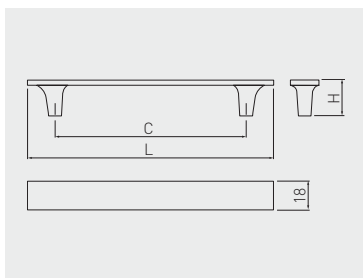

 C mm	 L mm	 H mm	 S mm		
				chrom chrome хром	ZnAl
96	111	21	23,5	UZ-SIENNA096-01	
128	142	23	25	UZ-SIENNA128-01	
160	186	24,5	26,5	UZ-SIENNA160-01	





Uchwyt LUCCA
Handle LUCCA
Ручка LUCCA

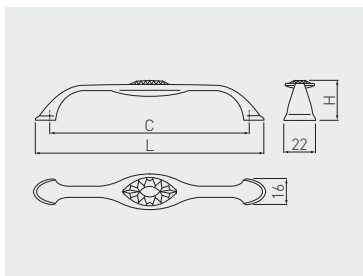

 C mm	 L mm	 H mm		
			chrom chrome хром	ZnAl
96	131	22,5	UZ-LUCCA096-01	
128	163	23	UZ-LUCCA128-01	
160	196	23	UZ-LUCCA160-01	
192	228	23,5	UZ-LUCCA192-01	

Uchwyt BIANCA
Handle BIANCA
Ручка BIANCA



 C mm	 L mm	 H mm		
			chrom chrome хром	ZnAl
96	114	25	UZ-BIANC-96-01	
128	146	26	UZ-BIANC-128-01	

Gatka GZ—CRPA
Knob GZ—CRPA
Ручка GZ—CRPA

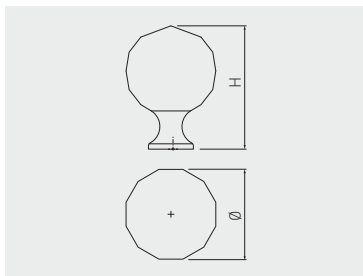

		chrom / biały kryształ chrome / white crystal хром / белый кристалл	chrom / czarny kryształ chrome / black crystal хром / чёрный кристалл	mosiądz / biały kryształ brass / white crystal латунь / белый кристалл	
20	33	GZ-CRPA20-01	GZ-CRPA20-A1	GZ-CRPA20-03	ZnAl, szkło ZnAl, glass ZnAl, стекло
25	37	GZ-CRPA25-01	GZ-CRPA25-A1	GZ-CRPA25-03	
30	44	GZ-CRPA30-01	GZ-CRPA30-A1	GZ-CRPA30-03	
40	55	GZ-CRPA40-01	GZ-CRPA40-A1	GZ-CRPA40-03	

Gatka GZ—CRPB
Knob GZ—CRPB
Ручка GZ—CRPB

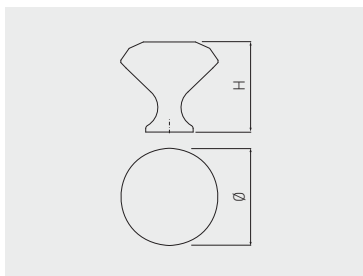

		chrom / biały kryształ chrome / white crystal хром / белый кристалл	chrom / czarny kryształ chrome / black crystal хром / чёрный кристалл	mosiądz / biały kryształ brass / white crystal латунь / белый кристалл	
20	26	GZ-CRPB20-01	GZ-CRPB20-A1	GZ-CRPB20-03	ZnAl, szkło ZnAl, glass ZnAl, стекло
25	28	GZ-CRPB25-01	GZ-CRPB25-A1	GZ-CRPB25-03	
30	30	GZ-CRPB30-01	GZ-CRPB30-A1	GZ-CRPB30-03	
40	38	GZ-CRPB40-01	GZ-CRPB40-A1	GZ-CRPB40-03	

Gatka GZ—CRPC
 Knob GZ—CRPC
 Ручка GZ—CRPC

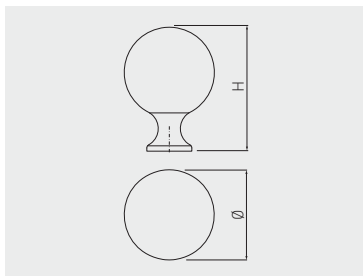

		chrom / biały kryształ chrome / black crystal хром / белый кристалл	chrom / czarny kryształ chrome / black crystal хром / чёрный кристалл	ZnAl, szkło ZnAl, glass ZnAl, стекло
30	43	GZ-CRPC30-01	GZ-CRPC30-A1	
40	54	GZ-CRPC40-01	GZ-CRPC40-A1	



Uchwyt KID
Handle KID
Ручка KID

NEW

CHILDREN



BLOCK



CLOUD



STAR



BUTTON



FLAMING



HEART



CROWN



TWITT

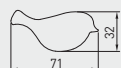
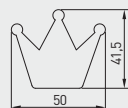
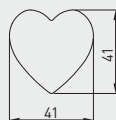
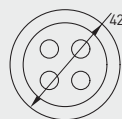
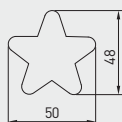
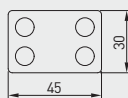

	zielony green зеленый	niebieski blue синий	czerwony red красный	szary grey серый	żółty yellow желтый	różowy pink розовый	
block	UM-BLOCK-ZL	UM-BLOCK-NB	UM-BLOCK-CZ	-	-	-	guma, ZnAl rubber, ZnAl резина, ZnAl
cloud	-	UM-CLOUD-NB	-	UM-CLOUD-SZ	-	-	
star	-	UM-STAR-NB	-	-	UM-STAR-ZT	UM-STAR-RZ	
button	-	UM-BUTTON-NB	-	UM-BUTTON-SZ	-	-	
flaming	-	-	-	UM-FLAMING-SZ	-	UM-FLAMING-RZ	
heart	-	-	-	-	-	UM-HEART-RZ	
crown	-	-	-	-	-	UM-CROWN-RZ	
twitt	UM-TWITT-ZL	-	-	UM-TWITT-SZ	-	-	



Uchwyt KID WILD
Handle KID WILD
Ручка KID WILD



UM-KID-I-002



UM-KID-P-001



UM-KID-Q-001



UM-KID-S-001



UM-KID-U-001



UM-KID-Y-001



tygrys / tiger / тигр	UM-KID-I-002	guma, ZnAl rubber, ZnAl резина, ZnAl
stoń / elephant / слон	UM-KID-P-001	
krokodyl / crocodile / крокодил	UM-KID-Q-001	
hipopotam / hippo / бегемот	UM-KID-S-001	
panda / panda / панда	UM-KID-U-001	
pingwin / penguin / пингвин	UM-KID-Y-001	

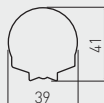
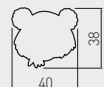
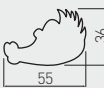

Uchwyt KID PLAY
Handle KID PLAY
Ручка KID PLAY



UM-KID-C-001



UM-KID-D-001



UM-KID-E-001



kwiatek / flower / цветок	UM-KID-C-001	guma, ZnAl rubber, ZnAl резина, ZnAl
samochód / car / автомобиль	UM-KID-D-001	
piłka / ball / мяч	UM-KID-E-001	



Uchwyt KID FARM
Handle KID FARM
Ручка KID FARM



UM-KID-W-001



UM-KID-X-001



UM-KID-Z-001



UM-UNICORN-RZ



konik / horse / лошадь	UM-KID-W-001	guma, ZnAl rubber, ZnAl резина, ZnAl
królik / rabbit / кролик	UM-KID-X-001	
piesek / dog / собака	UM-KID-Z-001	
jednorożec / unicorn / единорог	UM-UNICORN-RZ	

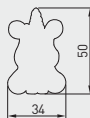

Chcesz sprawdzić jak wygląda uchwyt na frontach mebli przed zakupem?
Do you want to check how your piece of furniture will look with GTV handles?
Хочешь проверить как будут смотреться ручки GTV в интерьере?

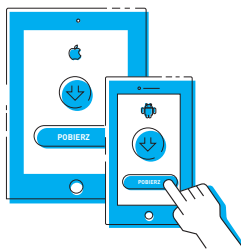

Uruchom aplikację
Start the app
Запустите приложение

1

KROK

Ściągnij i zainstaluj aplikację ze strony: www.uchwyty.gtv.com.pl lub ze sklepów googleplay i appstore – aplikacja **VIEW AT HOME**.

STEP

Download and install the app for the site: www.uchwyty.gtv.com.pl or from the google play store or appstore – the app is called **VIEW AT HOME**.

ШАГ

Скачай и установи бесплатное приложение с www.uchwyty.gtv.com.pl для смартфонов с операционной системой Android и IOS – приложение **VIEW AT HOME**.

↓ Pobierz za darmo
Download for free
Скачайте бесплатно



2

KROK

Wybierz kategorię uchwytów meblowych i dobierz odpowiedni model uchwytu.

STEP

Select the category of furniture handles and select desired model.

ШАГ

Выберите категорию лицевой фурнитуры и выберите модель ручки.

Wyświetl uchwyt
Display a handle
Посмотреть

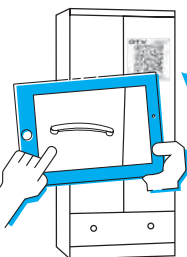
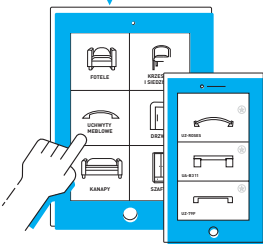

3

KROK

Naklej marker na froncie mebla, skieruj kamerę urządzenia na marker i zobacz jak wygląda wybrany uchwyt na meblu.

STEP

Attach the marker on the furniture front, direct the device's camera onto the marker and see how the selected handle looks on the furniture front.

ШАГ

Прикрепите конфигуратор к мебельному фасаду. Направьте камеру на конфигуратор. Проверьте как ручка смотрится в интерьере.



Wytnij poniższy marker
Cut out the marker below
Вырежьте конфигурактор

GTV

1. ŚCIĄGNIJ I ZAINSTALUJ APLIKACJĘ ZE STRONY
2. WYBIERZ KATEGORIĘ UCHWYTÓW MEBLOWYCH
3. DOBIERZ ODPOWIEDAJĄCY CI MODEL
4. NAKLEJ ZNACZNIK NA FRONCIE MEBLA I ZAARANŻUJ GO WYBRANYM UCHWYTEM

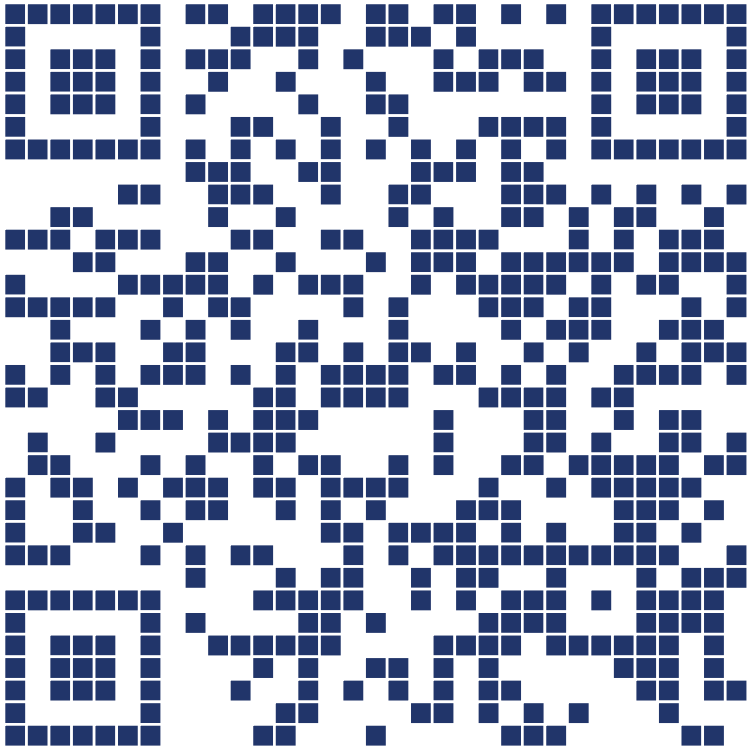

1. DOWNLOAD AND INSTALL APP FORM THE WEBSITE
2. CHOOSE A CATEGORY OF FURNITURE HANDLES
3. SELECT THE DESIRED FURNITURE HANDLE MODEL
4. STICK THE MARKER ON THE FRONT PANEL OF YOUR FURNITURE PIECE, ARRANGE IT WITH YOUR SELECTED HANDLE

1. СКАЧАЙТЕ И УСТАНОВИТЕ ПРОГРАММУ НА СМАРТФОН ИЛИ ПЛАНШЕТ
2. ВЫБЕРИТЕ ИНТЕРЕСУЮЩУЮ ВАС КАТЕГОРИЮ
3. ВЫБЕРИТЕ ПОНРАВИВШУЮСЯ ВАМ РУЧКУ
4. ПРИКРЕПИТЕ КОНФИГУРАТОР К МЕБЕЛЬНОМУ ФАСАДУ И ПРОВЕРЬТЕ КАК РУЧКА СМОТРИТСЯ В ИНТЕРЬЕРЕ

Wieszak SOLO
Hook SOLO
Крючок SOLO

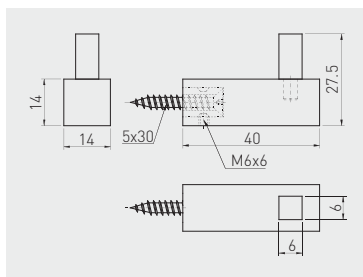

WS-SOLO-14-06



stal szczotkowana / brushed steel / шлифованная сталь



stal / steel / сталь

Wieszak QUADRO*
Hook QUADRO*
Крючок QUADRO*

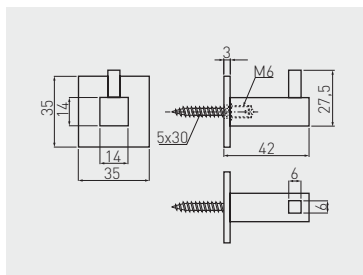

WS-QUAD-14-06



stal szczotkowana / brushed steel / шлифованная сталь



stal / steel / сталь

*Dostępny na zamówienie / Available only for individual order / Доступен под заказ

Wieszak RONDO*
Hook RONDO*
Крючок RONDO*

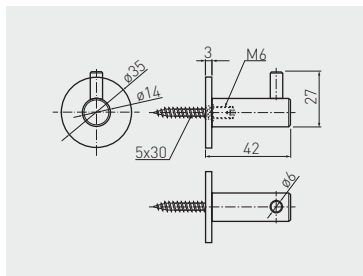

WS-ROND-14-06

stal szcztokowana / brushed steel / шлифованная сталь

stal / steel / сталь

*Dostępny na zamówienie / Available only for individual order / Доступен под заказ

Wieszak 804
Hook 804
Крючок 804

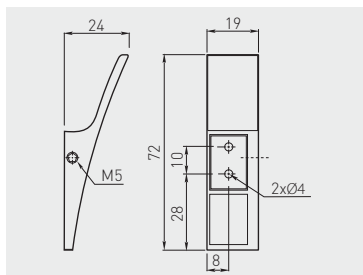

WZ-804-20-01

chrom / chrome / хром

WZ-804-20-05

aluminium / aluminium / алюминий

WZ-804-20-06

stal szcztokowana / brushed steel / шлифованная сталь

ZnAl

Wieszak TOLEDO A0
Hook TOLEDO A0
Крючок TOLEDO A0

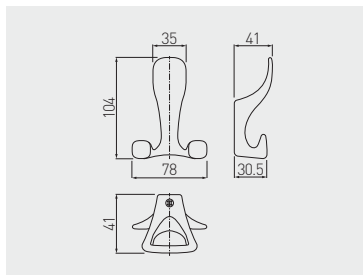

WZ-TOLED-A0-01	chrom / chrome / хром	ZnAl
WZ-TOLED-A0-02	satyna / satin / сатин	
WZ-TOLED-A0-05	aluminium / aluminium / алюминий	
WZ-TOLED-A0-06	stal szczotkowana / brushed steel / шлифованная сталь	
WZ-TOLED-A0-20M	czarny mat / black matt / чёрный матовый	

Wieszak TOLEDO B0
Hook TOLEDO B0
Крючок TOLEDO B0

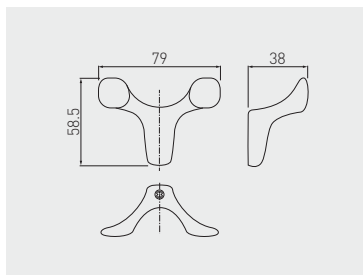

WZ-TOLED-B0-01	chrom / chrome / хром	ZnAl
WZ-TOLED-B0-02	satyna / satin / сатин	
WZ-TOLED-B0-05	aluminium / aluminium / алюминий	
WZ-TOLED-B0-06	stal szczotkowana / brushed steel / шлифованная сталь	
WZ-TOLED-B0-20M	czarny mat / black matt / чёрный матовый	

Wieszak TOLEDO C0
 Hook TOLEDO C0
 Крючок TOLEDO C0

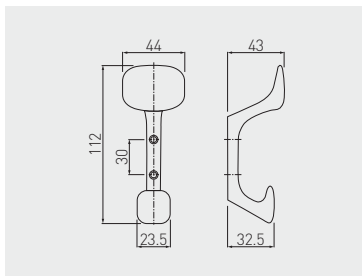

WZ-TOLED-C0-01	chrom / chrome / хром	ZnAl
WZ-TOLED-C0-02	satyna / satin / сатин	
WZ-TOLED-C0-05	aluminium / aluminium / алюминий	
WZ-TOLED-C0-06	stal szcztotkowana / brushed steel / шлифованная сталь	
WZ-TOLED-C0-20M	czarny mat / black matt / чёрный матовый	



Wieszak WALENCIA
Hook WALENCIA
Крючок WALENCIA

NEW

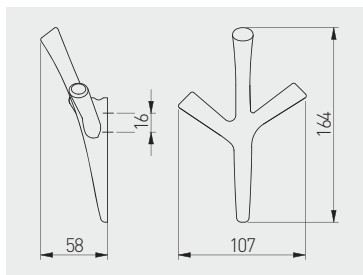

WZ-WALENCIA-01	chrom / chrome / хром	ZnAl
WZ-WALENCIA-06	stal szcztokowana / brushed steel / шлифованная сталь	
WZ-WALENCIA-20M	czarny mat / black matt / чёрный матовый	

Wieszak CORDOBA
Hook CORDOBA
Крючок CORDOBA

NEW

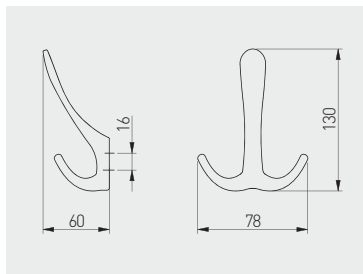

WZ-CORDOBA-01	chrom / chrome / хром	ZnAl
WZ-CORDOBA-06	stal szcztokowana / brushed steel / шлифованная сталь	
WZ-CORDOBA-20M	czarny mat / black matt / чёрный матовый	

Wieszak K2201
Hook K2201
Крючок K2201

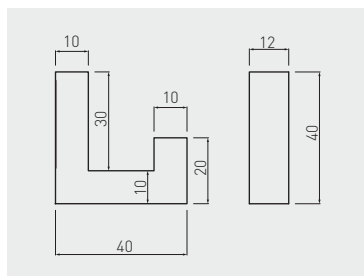

WZ-K2201-01	chrom / chrome / хром	ZnAl
WZ-K2201-06	stal szcziotkowana / brushed steel / шлифованная сталь	
WZ-K2201-CZ	czarny / black / чёрный	
WZ-K2201-ZL	zielony / green / зелёный	
WZ-K2201-NB	niebieski / blue / синий	
WZ-K2201-PM	pomarańczowy / orange / оранжевый	
WZ-K2201-RZ	różowy / pink / розовый	
WZ-K2201-CS	kremowy / cream / кремовый	

Wieszak K2202
Hook K2202
Крючок K2202

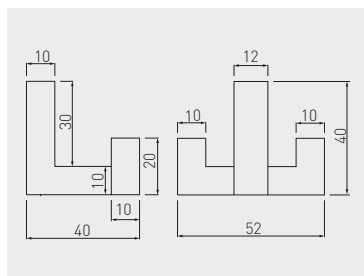

WZ-K2202-01	chrom / chrome / хром	ZnAl
WZ-K2202-06	stal szcziotkowana / brushed steel / шлифованная сталь	
WZ-K2202-CZ	czarny / black / чёрный	
WZ-K2202-PM	pomarańczowy / orange / оранжевый	
WZ-K2202-RZ	różowy / pink / розовый	
WZ-K2202-CS	kremowy / cream / кремовый	

Wieszak K23-A0
Hook K23-A0
Крючок K23-A0

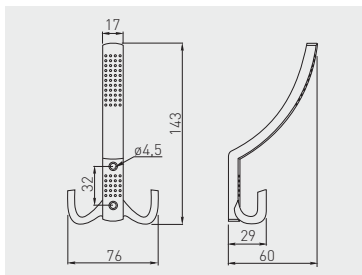

WZ-A0-K23-01	chrom / chrome / хром	ZnAl
WZ-A0-K23-02	satyna / satin / сатин	
WZ-A0-K23-03	mosiądz / brass / латунь	
WZ-A0-K23-04	antyczny mosiądz / antique brass / античная латунь	
WZ-A0-K23-05	aluminium / aluminium / алюминий	
WZ-A0-K23-06*	stal szczotkowana / brushed steel / шлифованная сталь	
WZ-A0-K23-07	antyczne srebro / antique silver / античное серебро	
WZ-A0-K23-20	czarny mat / black matt / чёрный матовый	

*Dostępny na zamówienie / Available only for individual order / Доступен под заказ

Wieszak K23-B0
Hook K23-B0
Крючок K23-B0

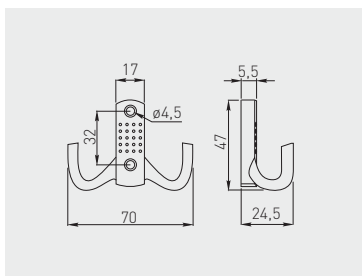

WZ-B0-K23-01	chrom / chrome / хром	ZnAl
WZ-B0-K23-02	satyna / satin / сатин	
WZ-B0-K23-03	mosiądz / brass / латунь	
WZ-B0-K23-04	antyczny mosiądz / antique brass / античная латунь	
WZ-B0-K23-05	aluminium / aluminium / алюминий	
WZ-B0-K23-06*	stal szczotkowana / brushed steel / шлифованная сталь	
WZ-B0-K23-07	antyczne srebro / antique silver / античное серебро	
WZ-B0-K23-20	czarny mat / black matt / чёрный матовый	

*Dostępny na zamówienie / Available only for individual order / Доступен под заказ

Wieszak K23-D1*
Hook K23-D1*
Крючок K23-D1*

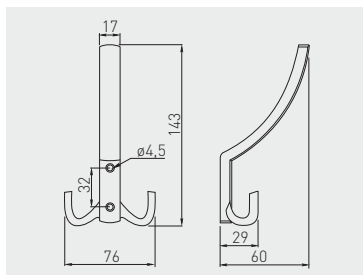

WZ-K23-D1-01	chrom / chrome / хром	ZnAl
WZ-K23-D1-02	satyna / satin / сатин	
WZ-K23-D1-03	mosiądz / brass / латунь	
WZ-K23-D1-05	aluminium / aluminium / алюминий	
WZ-K23-D1-06	stal szczotkowana / brushed steel / шлифованная сталь	

*Dostępny na zamówienie / Available only for individual order / Доступен под заказ

Wieszak K23-E1*
Hook K23-E1*
Крючок K23-E1*

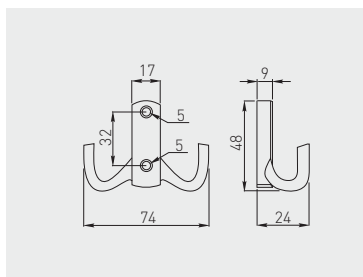

WZ-K23-E1-01	chrom / chrome / хром	ZnAl
WZ-K23-E1-02	satyna / satin / сатин	
WZ-K23-E1-03	mosiądz / brass / латунь	
WZ-K23-E1-05	aluminium / aluminium / алюминий	
WZ-K23-E1-06	stal szczotkowana / brushed steel / шлифованная сталь	

*Dostępny na zamówienie / Available only for individual order / Доступен под заказ

Wieszak GRANADA
Hook GRANADA
Крючок GRANADA

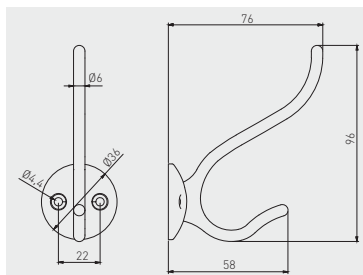

WZ-GRANA-A0-01

chrom / chrome / хром

ZnAl

Wieszak K24-A0
Hook K24-A0
Крючок K24-A0

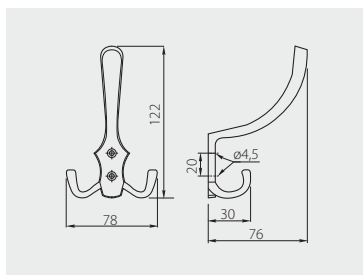

WZ-A0-K24-01

chrom / chrome / хром

WZ-A0-K24-02

satyna / satin / сатин

WZ-A0-K24-03

mosiądz / brass / латунь

WZ-A0-K24-04

antyczny mosiądz / antique brass / античная латунь

WZ-A0-K24-05

aluminium / aluminium / алюминий

WZ-A0-K24-07

antyczne srebro / antique silver / античное серебро

WZ-A0-K24-20

czarny mat / black matt / чёрный матовый

ZnAl

Wieszak K24-B0
Hook K24-B0
Крючок K24-B0

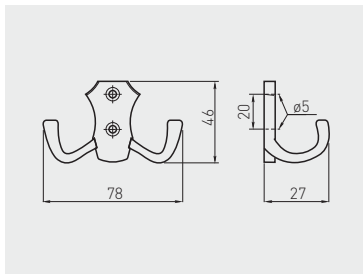

WZ-B0-K24-01	chrom / chrome / хром	ZnAl
WZ-B0-K24-02	satyna / satin / сатин	
WZ-B0-K24-03	mosiądz / brass / латунь	
WZ-B0-K24-04	antyczny mosiądz / antique brass / античная латунь	
WZ-B0-K24-05	aluminium / aluminium / алюминий	
WZ-B0-K24-07	antyczne srebro / antique silver / античное серебро	
WZ-B0-K24-20	czarny mat / black matt / чёрный матовый	



Wieszak K24-C0
Hook K24-C0
Крючок K24-C0

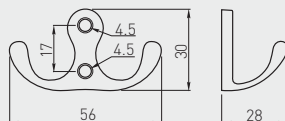

WZ-C0-K24-01	chrom / chrome / хром	ZnAl
WZ-C0-K24-02	satyna / satin / сатин	
WZ-C0-K24-03	mosiądz / brass / латунь	
WZ-C0-K24-04	antyczny mosiądz / antique brass / античная латунь	
WZ-C0-K24-05	aluminium / aluminium / алюминий	
WZ-C0-K24-20	czarny mat / black matt / чёрный матовый	

Wieszak MALAGA A0
Hook MALAGA A0
Крючок MALAGA A0

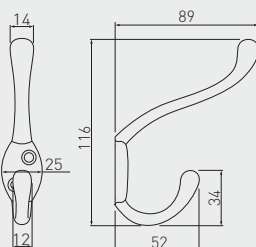

WA-MALAG-A0-01	chrom / chrome / хром	aluminium / aluminium / алюминий
WA-MALAG-A0-02	satyna / satin / сатин	
WA-MALAG-A0-05	aluminium / aluminium / алюминий	
WA-MALAG-A0-20	czarny / black / чёрный	

Wieszak MALAGA B0
 Hook MALAGA B0
 Крючок MALAGA B0

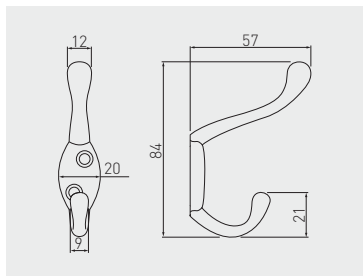

WA-MALAG-B0-01	chrom / chrome / хром	aluminium aluminium алюминий
WA-MALAG-B0-02	satyna / satin / сатин	
WA-MALAG-B0-05	aluminium / aluminium / алюминий	
WA-MALAG-B0-20	czarny / black / чёрный	

Wieszak MALAGA C0
 Hook MALAGA C0
 Крючок MALAGA C0

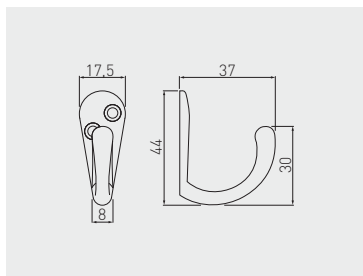

WZ-MALAG-C0-01	chrom / chrome / хром	ZnAl
WZ-MALAG-C0-02	satyna / satin / сатин	
WZ-MALAG-C0-05	aluminium / aluminium / алюминий	
WZ-MALAG-C0-20	czarny / black / чёрный	

Wieszak E18
Hook E18
Крючок E18

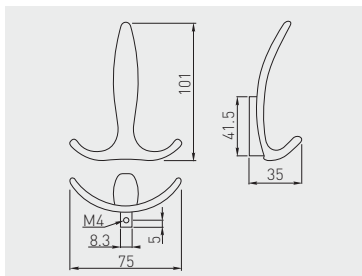

WZ-E-018-01	chrom / chrome / хром	ZnAl
WZ-E-018-02	satyna / satin / сатин	
WZ-E-018-05	aluminium / aluminium / алюминий	
WZ-E-018-06	stal szczotkowana / brushed steel / шлифованная сталь	
WZ-E-018-20M	czarny mat / black matt / чёрный матовый	

Wieszak D892
Hook D892
Крючок D892

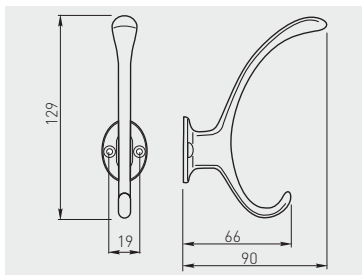

WZ-D-892-02	satyna / satin / сатин	ZnAl
WZ-D-892-05	aluminium / aluminium / алюминий	

Wieszak CORUNA-D
Hook CORUNA-D
Крючок CORUNA-D

NEW

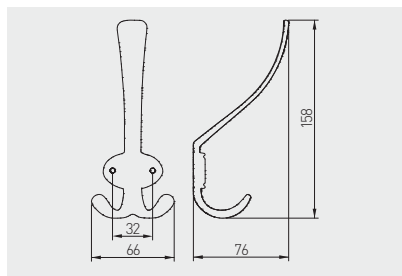

WZ-CORUNA-D-04	antyczny mosiądz / antique brass / античная латунь	ZnAl
WZ-CORUNA-D-07	antyczne srebro / antique silver / античное серебро	
WZ-CORUNA-D-17	brąz / bronze / коричневый	
WZ-CORUNA-D-20M	czarny mat / black matt / чёрный матовый	

Wieszak CORUNA-M
Hook CORUNA-M
Крючок CORUNA-M

NEW

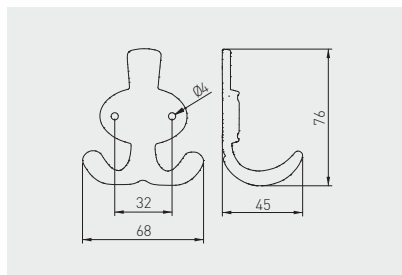

WZ-CORUNA-M-04	antyczny mosiądz / antique brass / античная латунь	ZnAl
WZ-CORUNA-M-07	antyczne srebro / antique silver / античное серебро	
WZ-CORUNA-M-17	brąz / bronze / коричневый	
WZ-CORUNA-M-20M	czarny mat / black matt / чёрный матовый	

Wieszak MADRYT
Hook MADRYT
Крючок MADRYT

NEW

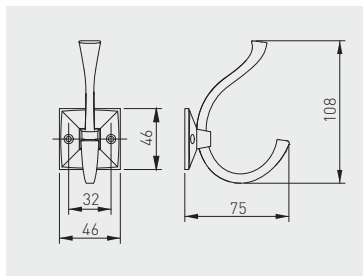

WZ-MADRYT-04	antyczny mosiądz / antique brass / античная латунь	ZnAl
WZ-MADRYT-07	antyczne srebro / antique silver / античное серебро	
WZ-MADRYT-15	antyczna miedź / antique copper / античная медь	
WZ-MADRYT-20M	czarny mat / black matt / чёрный матовый	



Wieszak ORVIETO A0
 Hook ORVIETO A0
 Крючок ORVIETO A0

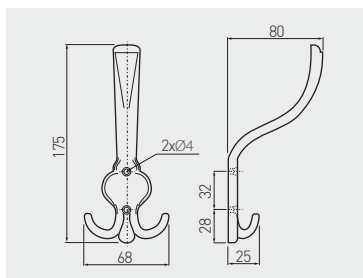

WZ-ORVIE-A0-09

antyczny mosiądz szczotkowany
 antique brushed brass
 античная шлифованная латунь

ZnAl

Wieszak ORVIETO B0
 Hook ORVIETO B0
 Крючок ORVIETO B0

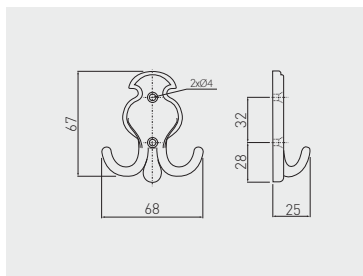

WZ-ORVIE-B0-09

antyczny mosiądz szczotkowany
 antique brushed brass
 античная шлифованная латунь

ZnAl

Wieszak K24
Hook K24
Крючок K24

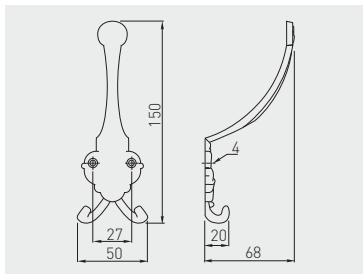

WZ-00-K24-04





antyczny mosiądz / antique brass / античная латунь

ZnAl

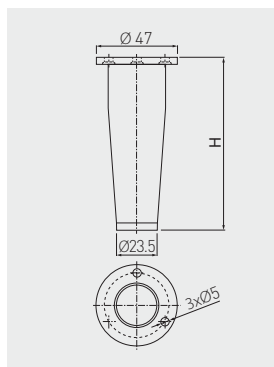

Nóżka B-103
Leg B-103
Ножка B-103



		 H mm		
NM-B103-80-01		80	chrom / chrome / хром	ZnAl
NM-B103-80-06			stal szczotkowana / brushed steel / шлифованная сталь	
NM-B103-100-01		100	chrom / chrome / хром	
NM-B103-100-06			stal szczotkowana / brushed steel / шлифованная сталь	
NM-B103-120-01		120	chrom / chrome / хром	
NM-B103-120-06			stal szczotkowana / brushed steel / шлифованная сталь	

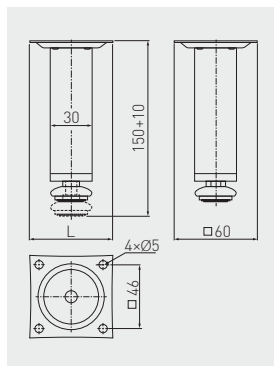

Nóżka BD-150 z regulacją
Adjustable leg BD-150
Ножка BD-150 с регулировкой



		 H mm		
NM-BD-150-01		150 + 10	chrom / chrome / хром	stal / steel / сталь
NM-BD-150-02			satyna / satin / сатин	

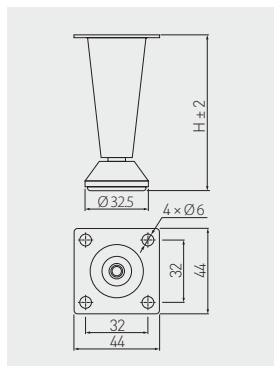



Nóżka RIO z regulacją
Adjustable leg RIO
Ножка RIO с регулировкой

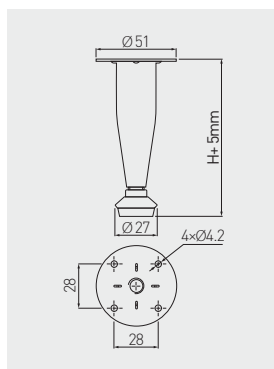

	 H mm		
NM-RIO-050-01	50 +/- 2	chrom / chrome / хром	ZnAl
NM-RIO-080-01	80 +/- 2		
NM-RIO-100-01	100 +/- 2		



Nóżka BD-03 z regulacją
Adjustable leg BD-03
Ножка BD-03 с регулировкой



	 H mm		
NM-BD-003-01	100 + 5	chrom / chrome / хром	stal / steel / сталь
NM-BD-003-02		satyna / satin / сатин	
NM-BD-003-150-01	150 + 5	chrom / chrome / хром	
NM-BD-003-150-02		satyna / satin / сатин	

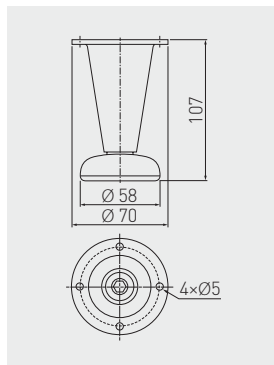

Nóżka BD-780
Leg BD-780
Ножка BD-780

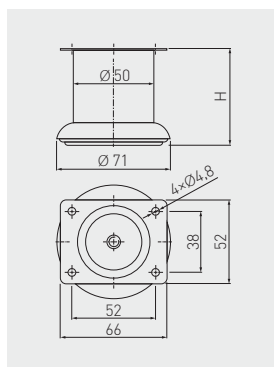

	 H mm		
NM-BD-780-M1	107	chrom / chrome / хром	stal / steel / сталь
NM-BD-780-M2		satyna / satin / сатин	
NM-BD-780-M5		aluminium / aluminium / алюминий	

Nóżka B-140
Leg B-140
Ножка B-140





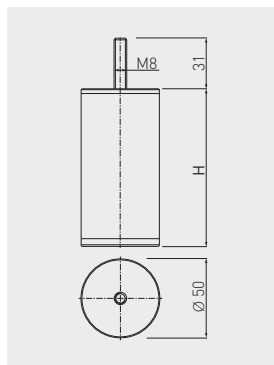

	 H mm		
NM-B-140-060	60	chrom chrome хром	stal, tworzywo steel, plastic сталь, пластмасса
NM-B-140-080	80		
NM-B-140-100	100		
NM-B-140-120*	120		
NM-B-140-150*	150		
NM-B-140-180*	180		
NM-B-140-200*	200		

* Dostępny na zamówienie / Available only for individual order / Доступен под заказ

Nóżka STR-50
Leg STR-50
Ножка STR-50



	 H mm		
NM-STR50-100-01	100	chrom chrome хром	stal, tworzywo steel, plastic сталь, пластмасса
NM-STR50-120-01	120		
NM-STR50-150-01	150		

Nóżka STR-60*
Leg STR-60*
Ножка STR-60*

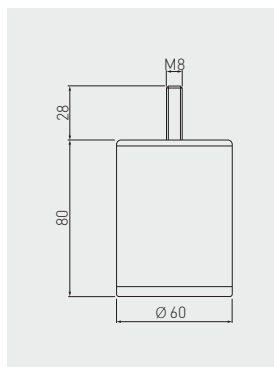



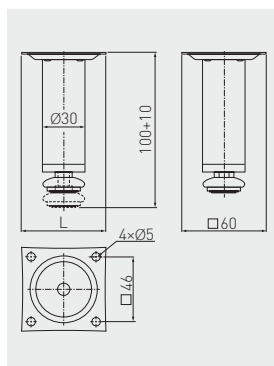

	 H mm		
NM-STR60-80-01	80	chrom chrome хром	stal, tworzywo steel, plastic сталь, пластмасса

*Dostępny na zamówienie / Available only for individual order / Доступен под заказ





Nóżka BD-100 z regulacją
Adjustable leg BD-100
Ножка BD-100 с регулировкой

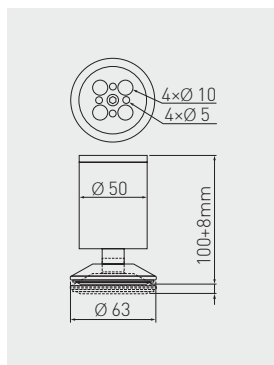

		 mm		
NM-BD-100-01		100 + 10	chrom / chrome / хром	stal / steel / сталь
NM-BD-100-02			satyna / satin / сатин	
NM-BD-100-05			aluminium / aluminium / алюминий	
NM-BD-100-06			stal szorstkowana / brushed steel / шлифованная сталь	

Nóżka BD-762 z regulacją
Adjustable leg BD-762
Ножка BD-762 с регулировкой



		 mm		
NM-BD-762-01		100 + 8	chrom / chrome / хром	ZnAl, stal / ZnAl, steel / ZnAl, сталь
NM-BD-762-05			aluminium / aluminium / алюминий	

Nóżka BD-867
Leg BD-867
Ножка BD-867

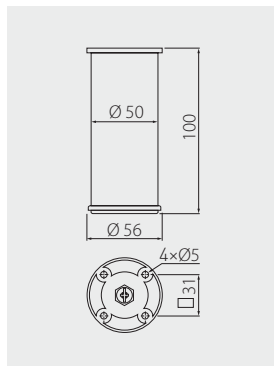

NM-BD867-100	100	aluminium / aluminium / алюминий	aluminium / aluminium / алюминий
--------------	-----	----------------------------------	----------------------------------

Nóżka BD-868
Leg BD-868
Ножка BD-868

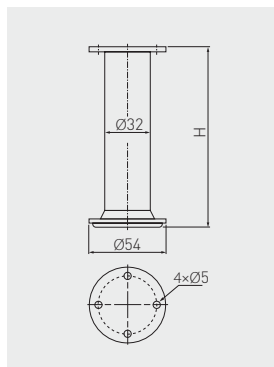

NM-BD868-100	100	aluminium / aluminium / алюминий	aluminium / aluminium / алюминий
NM-BD868-150	150		



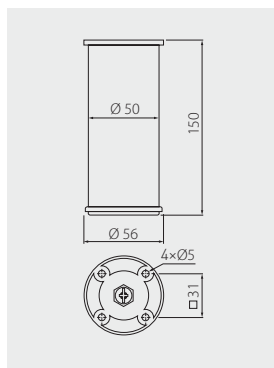

Nóżka BD-869
Leg BD-869
Ножка BD-869

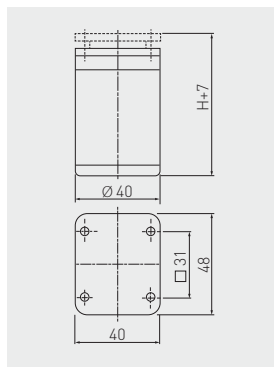

	 mm		
NM-BD869-150	150	aluminium / aluminium / алюминий	aluminium / aluminium / алюминий





Nóżka DAP-77 z regulacją
Adjustable leg DAP-77
Ножка DAP-77 с регулировкой высоты

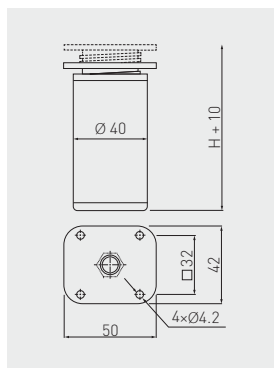

	 mm		
NM-DAP77-60	60 + 7	aluminium / aluminium / алюминий	aluminium, tworzywo aluminium, plastic алюминий, пластмасса
NM-DAP77-100	100 + 7		
NM-DAP77-150	150 + 7		

Nóżka NAC z regulacją*
Adjustable leg NAC*
Ножка NAC с регулировкой высоты*



	 H mm		
NM-NAC-27651-06	60 + 10	chrom chrome хром	aluminium, tworzywo aluminium, plastic алюминий, пластмасса
NM-NAC-27651-10	100 + 10		
NM-NAC-27651-15	150 + 10		

* Dostępny na zamówienie / Available only for individual order / Доступен под заказ



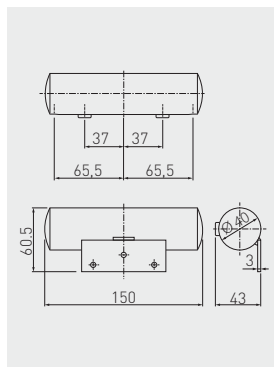

Nóżka BAHIA*
Leg BAHIA*
Ножка BAHIA*

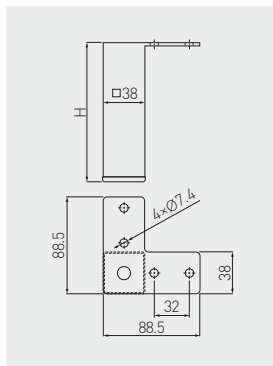

	 H mm		
NM-BAHIA40-150-01	43	chrom / chrome / хром	stal, tworzywo steel, plastic сталь, пластмасса





Nóżka B-104
Leg B-104
Ножка B-104

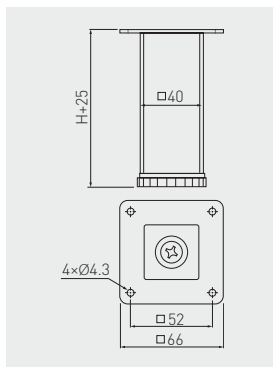

	 H mm		
NM-B104-100-01	100	chrom / chrome / хром	stal / steel / сталь
NM-B104-150-01	150		
NM-B104-200-01	200		

Nóżka SQ-40 z regulacją
Adjustable leg SQ-40
Ножка SQ-40 с регулировкой высоты



	 H mm		
NM-SQ40ADJ-060	60 + 25	chrom / chrome / хром	stal / steel / сталь
NM-SQ40ADJ-060-05*	60 + 25	aluminium, aluminium, алюминий,	
NM-SQ40ADJ-080*	80 + 25		
NM-SQ40ADJ-080-05*	80 + 25		
NM-SQ40ADJ-100-05*	100 + 25	chrom / chrome / хром	
NM-SQ40ADJ-100	100 + 25		

*Dostępny na zamówienie / Available only for individual order / Доступен под заказ

Nóżka SQA z regulacją
Adjustable leg SQA
Ножка SQA с регулировкой высоты

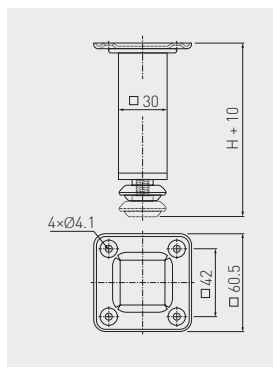

	 mm		
NM-SQA100-01	100 + 10	chrom / chrome / хром	stal / steel / сталь
NM-SQA150-01*	150 + 10		

*Dostępny na zamówienie / Available only for individual order / Доступен под заказ

Nóżka BD-727
Leg BD-727
Ножка BD-727

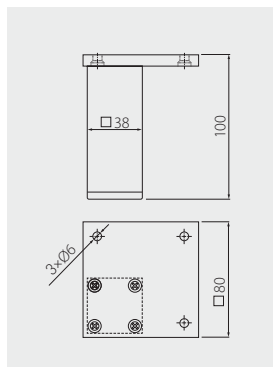

	 mm		
NM-BD727-100	100	aluminium / aluminium / алюминий	aluminium / aluminium / алюминий

Nóżka BD-739
Leg BD-739
Ножка BD-739

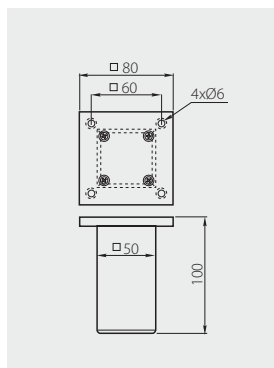

NM-BD-739-05	100	aluminium / aluminium / алюминий	aluminium / aluminium / алюминий
--------------	-----	----------------------------------	----------------------------------

Nóżka DAK-27 z regulacją
Adjustable leg DAK-27
Ножка DAK-27 с регулировкой высоты

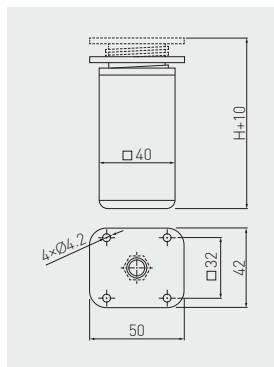

NM-DAK27-060	60 + 10	aluminium aluminium алюминий	aluminium, tworzywo aluminium, plastic алюминий, пластмасса
NM-DAK27-080	80 + 10		
NM-DAK27-100	100 + 10		
NM-DAK27-120	120 + 10		
NM-DAK27-150	150 + 10		

Nóżka NACK z regulacją*
Adjustable leg NACK*
Ножка NACK с регулировкой высоты*

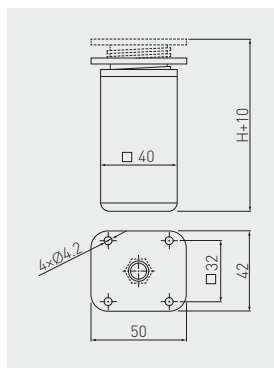

	 H mm		
NM-NACK27651-06	60 + 10	chrom chrome хром	tworzywo, aluminium plastic, aluminium пластмасса, алюминий
NM-NACK27651-10	100 + 10		

* Dostępny na zamówienie / Available only for individual order / Доступен под заказ

Nóżka TOKYO*
Leg TOKYO*
Ножка TOKYO*

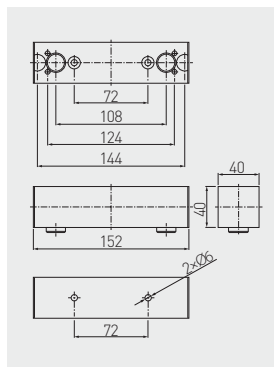

	 H mm		
NM-TOKYO40-150-01	40	chrom / chrome / хром	stal, tworzywo steel, plastic сталь, пластмасса

* Dostępny na zamówienie / Available only for individual order / Доступен под заказ

Nóżka BD-01
Leg BD-01
Ножка BD-01

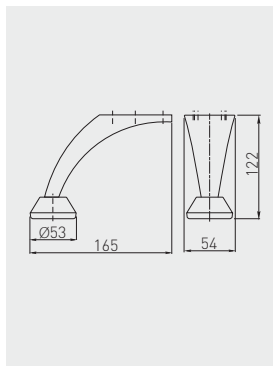

NM-BD-001-M1B

122

chrom / chrome / хром

stal / steel / сталь

Nóżka BD-712
Leg BD-712
Ножка BD-712

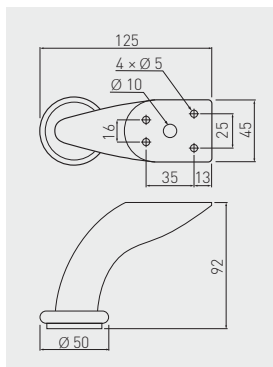

NM-BD-712-M1

92

chrom / chrome / хром

stal / steel / сталь

*Dostępny na zamówienie / Available only for individual order / Доступен под заказ

Nóżka STGC 50
Leg STGC 50
Ножка STGC 50

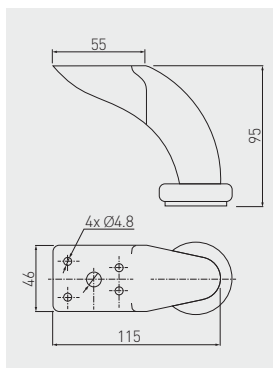

NM-STGC50-95-01	95	chrom / chrome / хром	stal / steel / сталь
-----------------	----	-----------------------	----------------------

Nóżka STGY 135
Leg STGY 135
Ножка STGY 135

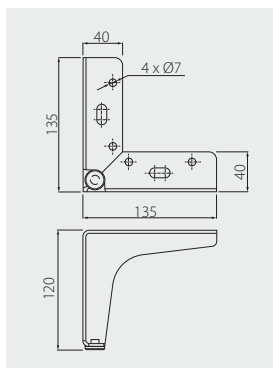

NM-STGY135-100-01	100	chrom / chrome / хром	stal, tworzywo steel, plastic сталь, пластик
NM-STGY135-130-01	130		
NM-STGY135-150-01	150		

Nóżka STGY-135
Leg STGY-135
Ножка STGY-135

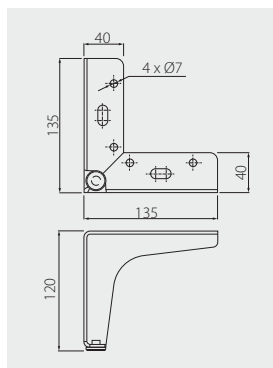

NM-STGY135-120-01

120

chrom / chrome / хром

stal / steel / сталь

Nóżka STOMP
Leg STOMP
Ножка STOMP

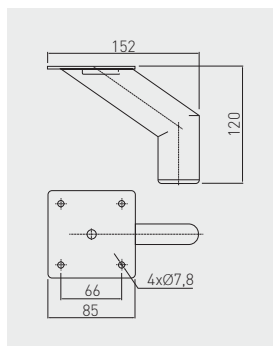

NM-STOMP-100-01*	100	chrom / chrome / хром	stal steel сталь
NM-STOMP-120-20	120	czarny / black / чёрный	
NM-STOMP-120-10*		biały / white / белый	
NM-STOMP-130-01*	130	chrom / chrome / хром	
NM-STOMP-130-20*		czarny / black / чёрный	
NM-STOMP-130-06*		stal szczerotkowana / brushed steel / шлифованная сталь	
NM-STOMP-150-01*	150	chrom / chrome / хром	
NM-STOMP-160-01*		160	
NM-STOMP-160-20*	stal szczerotkowana / brushed steel / шлифованная сталь		
NM-STOMP-160-06*			

*Dostępny na zamówienie / Available only for individual order / Доступен под заказ

Nóżka STOMP
Leg STOMP
Ножка STOMP

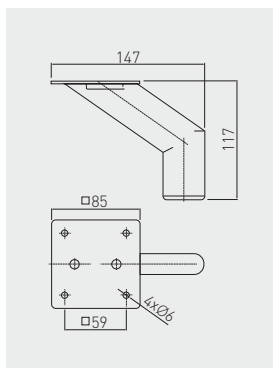

NM-STOMP-120-01



117



chrom / chrome / хром



stal / steel / сталь

Nóżka STPL 135
Leg STPL 135
Ножка STPL 135

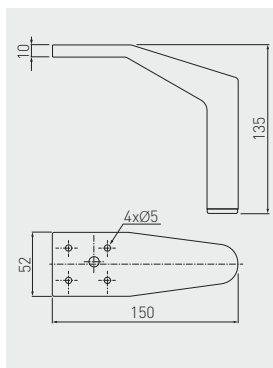

NM-STPL-135-01



135



chrom / chrome / хром



stal / steel / сталь

Nóżka MDN-D4
Leg MDN-D4
Ножка MDN-D4

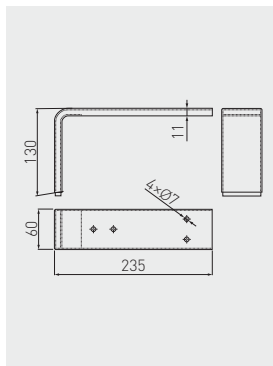

	 mm		
NM-MDN-D4-01	130	chrom / chrome / хром	stal / steel / сталь

Nóżka XH-30*
Leg XH-30*
Ножка XH-30*

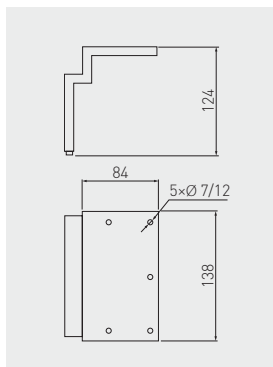

	 mm		
NM-XH3065-05	124	aluminium / aluminium / алюминий	aluminium / aluminium / алюминий

* Dostępny na zamówienie / Available only for individual order / Доступен под заказ

Nóżka XH-82
Leg XH-82
Ножка XH-82

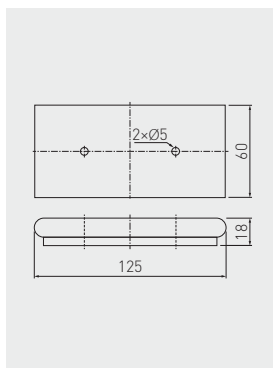

NM-XH8273-01



18



chrom / chrome / хром



ZnAl

Nóżka MDN-926
Leg MDN-926
Ножка MDN-926

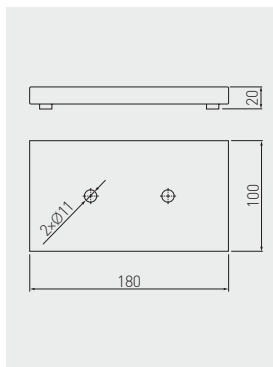

NM-MDN926-01



20



chrom / chrome / хром



stal / steel / сталь

Nóżka MDN-927
Leg MDN-927
Ножка MDN-927

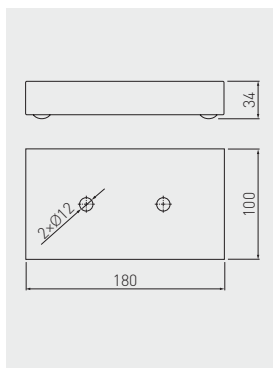

NM-MDN927-01	34	chrom / chrome / хром	stal / steel / сталь
--------------	----	-----------------------	----------------------

Nóżka MDN-941
Leg MDN-941
Ножка MDN-941

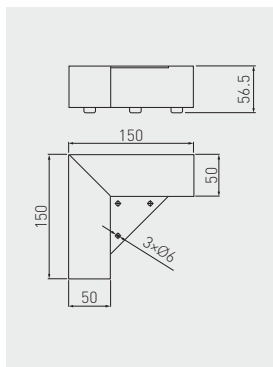

NM-MDN941-01	56	chrom / chrome / хром	stal / steel / сталь
--------------	----	-----------------------	----------------------

Nóżka STSL
Leg STSL
Ножка STSL

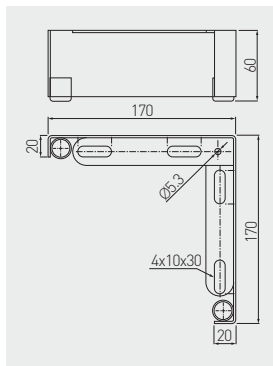

NM-STSL-170-60-01



60



chrom / chrome / хром



stal / steel / сталь



Ślizgacz WPJ z regulacją
Adjustable furniture slider WPJ
Опора WPJ с регулировкой

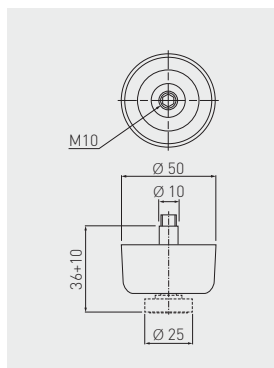

NM-WPJ22-D20



36 + 10



czarny / black / чёрный



tworzywo / plastic / пластмасса

Ślizgacz SLZ pojedynczy
Furniture slider SLZ single
Опора SLZ одинарная

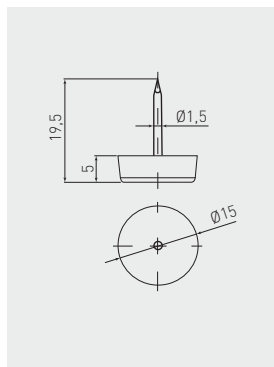

BP-SLZIGW-10



czarny / black / чёрный



tworzywo / plastic / пластмасса

Ślizgacz SLZ podwójny
Furniture slider SLZ double
Опора SLZ двойная

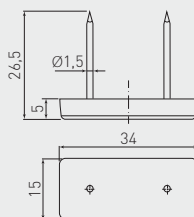

BP-SLZIGW-21



czarny
black
чёрный



tworzywo
plastic
пластмасса

Stopka M6 regulowana
Foot M6 adjustable
Ножка M6 с регулировкой

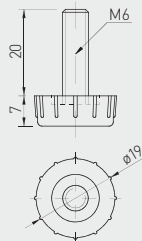

NM-STOPKA-M6



osynek
galvanized
гальваника



stal, tworzywo
steel, plastic
сталь, пластмасса

Stopka M6 regulowana sześciokątna
Foot M6 adjustable hexagonal
Ножка M6 с регулировкой (шестигранная)

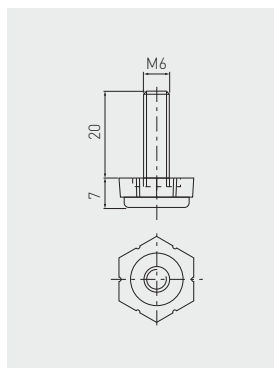

NM-STOPKSZESTK-M6



osynk
galvanized
гальваника



stal, tworzywo
steel, plastic
сталь, пластмасса

Mufa M6
Socket M6
Муфта M6



NM-MUFAWB-00



NM-MUFAWK-00

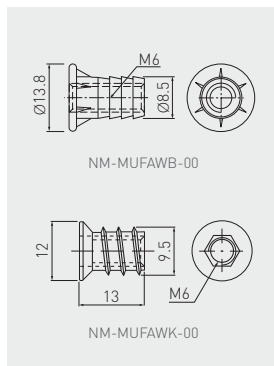

NM-MUFAWB-00



wbijana
screw-in sleeve
врезная



srebrny
silver
серебряный



ZnAl

NM-MUFAWK-00

wkręcana
screwed
для вкручивания

Nóżka DPD z regulacją
Adjustable leg DPD
Ножка DPD с регулировкой

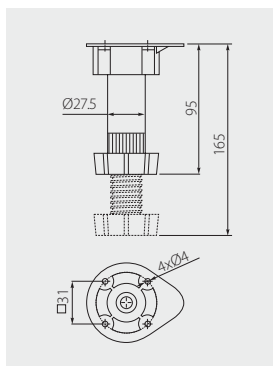

NM-DPD20-100	95 - 165	60	czarny / black / чёрный	tworzywo / plastic / пластмасса
--------------	----------	----	-------------------------	---------------------------------



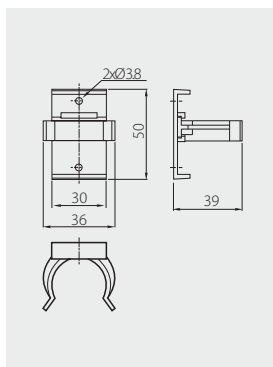



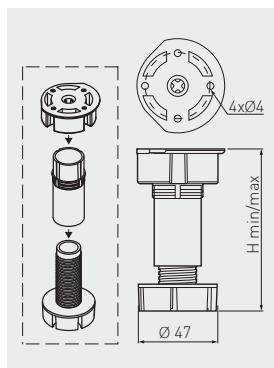

Klip do nóżki DPD
Plinth clip DPD
Клипса к ножке DPD



NM-KL-DPL-20	czarny / black / чёрный	tworzywo / plastic / пластмасса
--------------	-------------------------	---------------------------------

Nóżka DPA
Leg DPA
Ножка DPA



			 H mm	 kg		
NM-DPA20-100	pakowane w karton packing in box картонная упаковка		87 - 120	100		tworzywo plastic пластмасса
NM-DPA20-150			137 - 170			
NM-DPA20-100W	pakowane w worek packing in plastic bag полиэтиленовый пакет		87 - 120			
NM-DPA20-150W	137 - 170					

Klip do nóżki DPA
Plinth clip DPA
Клипса к ножке DPA

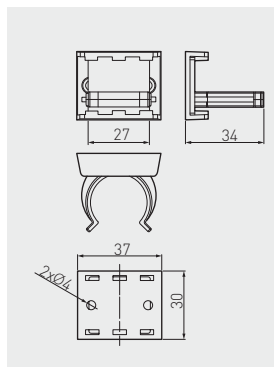

			
NM-KL-DPA-20		czarny / black / чёрный	tworzywo / plastic / пластмасса

Nóżka MLA-50 z regulacją
Adjustable leg MLA-50
Ножка MLA-50 с регулировкой

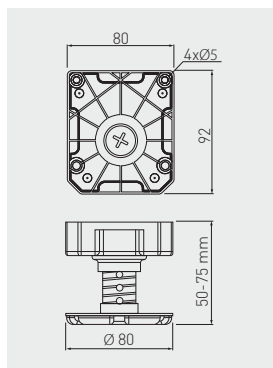

	 H mm	 kg		
NM-MLA-50-75	50-75	450	czarny / black / чёрный	tworzywo / plastic / пластмасса

Nóżka MLA-65 z regulacją
Adjustable leg MLA-65
Ножка MLA-65 с регулировкой

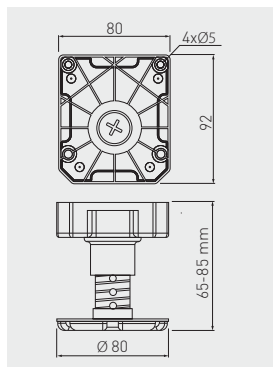

	 H mm	 kg		
NM-MLA-65-85	65-85	450	czarny / black / чёрный	tworzywo / plastic / пластмасса

Nóżka MLA-85 z regulacją
Adjustable leg MLA-85
Ножка MLA-85 с регулировкой

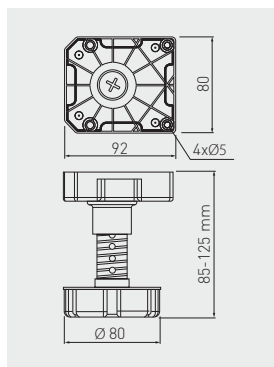

				
NM-MLA-85-125	85-125 mm	450 kg	czarny / black / чёрный	tworzywo / plastic / пластмасса

Nóżka MLA-95 z regulacją
Adjustable leg MLA-95
Ножка MLA-95 с регулировкой

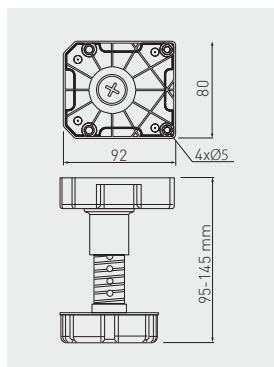

				
NM-MLA-95-145	95-145 mm	450 kg	czarny / black / чёрный	tworzywo / plastic / пластмасса

Nóżka MLA-125 z regulacją
Adjustable leg MLA-125
Ножка MLA-125 с регулировкой

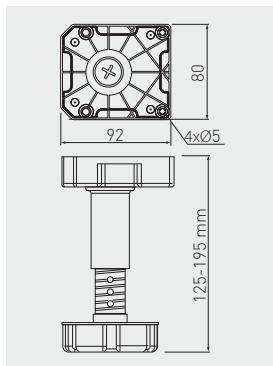

				
NM-MLA-125-195	125-195 mm	450 kg	czarny / black / чёрный	tworzywo / plastic / пластмасса

Klip do nóżek MLA
Clip for MLA legs
Клипса к ножке MLA

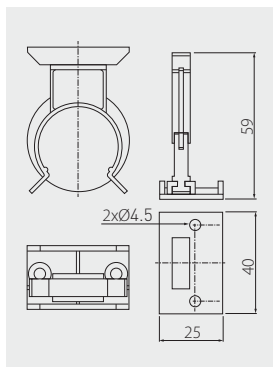

		
NM-MLA-KL	czarny / black / чёрный	tworzywo / plastic / пластмасса

Mechanizm zapadkowy zagłówek sofy
 Ratchet mechanism of the sofa's bolster
 Механизм трансформации подголовника

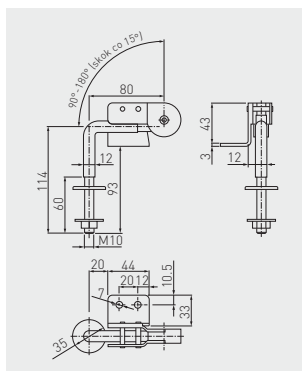

AMS-MPST001-0C

kąt otwarcia 90°-180°
 opening angle 90°-180°
 угол открытия 90°-180°

stal
 steel
 сталь



Noga A6 z regulacją
Adjustable leg A6
Опора A6 с регулировкой

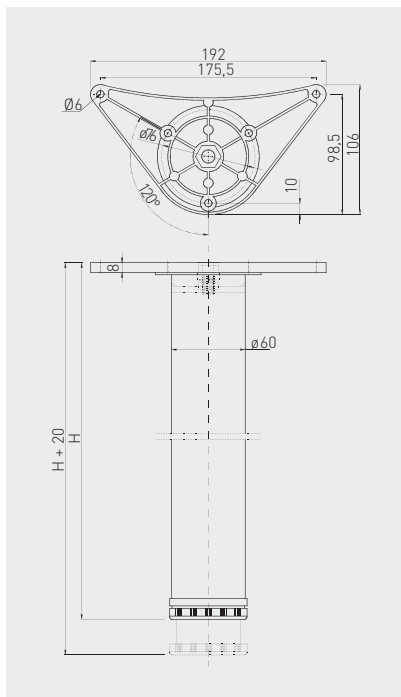

NM-A60710-01	710 + 30	chrom / chrome / хром	ZnAl, stal ZnAl, steel ZnAl, сталь
NM-A60710-02		satyna / satin / сатин	
NM-A60710-05		aluminium / aluminium / алюминий	
NM-A60710-10*		biały / white / белый	
NM-A60710-20		czarny / black / чёрный	
NM-A60710-80		srebrny / silver / серебристый	
NM-A60820-01	820 + 30	chrom / chrome / хром	
NM-A60820-02		satyna / satin / сатин	
NM-A60820-05		aluminium / aluminium / алюминий	
NM-A60820-10*		biały / white / белый	
NM-A61100-01	1100 + 30	chrom / chrome / хром	
NM-A61100-02		satyna / satin / сатин	
NM-A61100-05		aluminium / aluminium / алюминий	
NM-A61100-06		stal szcztokowana / brushed steel / шлифованная сталь	
NM-A61100-10*		biały / white / белый	
NM-A61100-20*		czarny / black / чёрный	

* Dostępny na zamówienie / Available only for individual order / Доступен под заказ

Noga NM-A80 z regulacją
Adjustable leg NM-A80
Опора NM-A80 с регулировкой

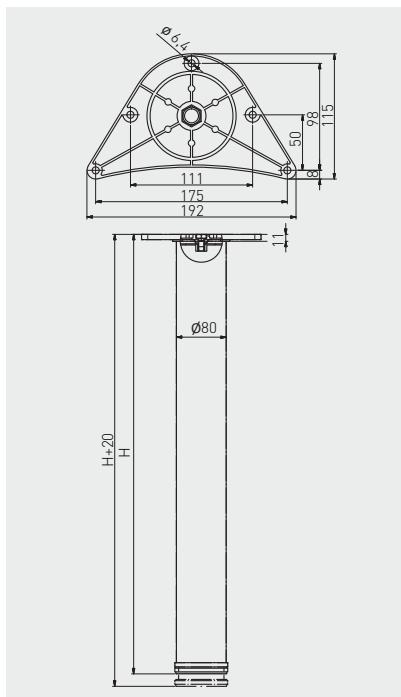

NM-A80710-01*	710 + 20	chrom / chrome / хром	ZnAl, stal ZnAl, steel ZnAl, сталь
NM-A80710-02*		satyna / satin / сатин	
NM-A80710-03*		złoty / gold / золото	
NM-A80710-05*		aluminium / aluminium / алюминий	
NM-A80710-06*		stal szcztokowana / brushed steel / шлифованная сталь	
NM-A80710-10*		biały / white / белый	
NM-A80710-20*		czarny / black / чёрный	
NM-A80710-80*	srebrny / silver / серебристый		
NM-A80870-01*	870 + 20	chrom / chrome / хром	
NM-A80870-02*		satyna / satin / сатин	
NM-A80870-03*		złoty / gold / золото	
NM-A80870-05*		aluminium / aluminium / алюминий	
NM-A80870-06*		stal szcztokowana / brushed steel / шлифованная сталь	
NM-A80870-10*		biały / white / белый	
NM-A80870-20*		czarny / black / чёрный	
NM-A80870-80*	srebrny / silver / серебристый		

* Dostępny na zamówienie / Available only for individual order / Доступен под заказ

Noga G6 z regulacją
Adjustable leg G6
Опора G6 с регулировкой

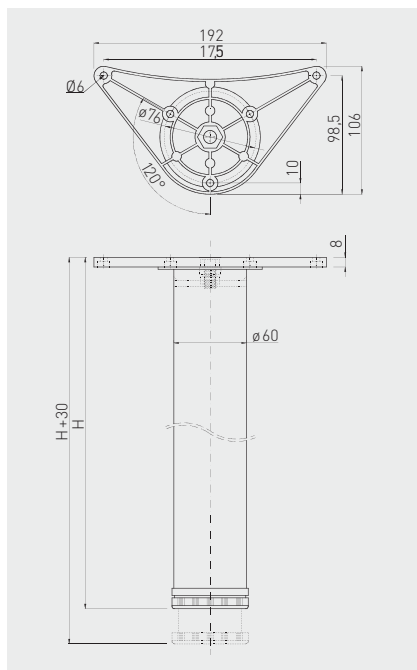

		 H mm		
NM-G60710-01		710 + 30	chrom / chrome / хром	ZnAl, stal ZnAl, steel ZnAl, сталь
NM-G60710-02			satyna / satin / сатин	
NM-G60710-03			mosiądz / brass / латунь	
NM-G60710-05			aluminium / aluminium / алюминий	
NM-G60710-06			stal szczotkowana / brushed steel / шлифованная сталь	
NM-G60710-20			czarny / black / чёрный	
NM-G60710-80		srebrny / silver / серебристый		
NM-G60820-01		820 + 30	chrom / chrome / хром	
NM-G60820-05			aluminium / aluminium / алюминий	
NM-G60820-06			stal szczotkowana / brushed steel / шлифованная сталь	
NM-G60820-20		czarny / black / чёрный		
NM-G61100-01		1100 + 30	chrom / chrome / хром	
NM-G61100-20			czarny / black / чёрный	

* Na zamówienie dostępna w kolorze białym / For special orders available in white color / Под заказ доступна в белом цвете

Noga S6 z regulacją
Adjustable leg S6
Опора S6 с регулировкой

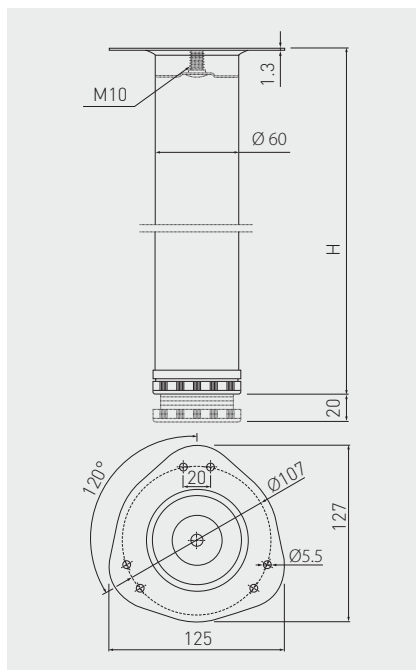

		 H mm		
NM-S60710-01A*		710 + 20	chrom / chrome / хром	stal / steel / сталь
NM-S60710-01 (A)			satyna / satin / сатин	
NM-S60710-02 (A)			aluminium / aluminium / алюминий	
NM-S60710-05 (A)			biały / white / белый	
NM-S60710-10 (A)			czarny / black / чёрный	
NM-S60820-01A*		820 + 20	chrom / chrome / хром	
NM-S60820-01 (A)			satyna / satin / сатин	
NM-S60820-02 (A)			aluminium / aluminium / алюминий	
NM-S60820-05 (A)			biały / white / белый	
NM-S60820-10 (A)			czarny / black / чёрный	

* Na zamówienie dostępna w kolorze białym / For special orders available in white color / Под заказ доступна в белом цвете

Noga F-50 składana*
 Leg F-50 foldable*
 Складная опора F-50*

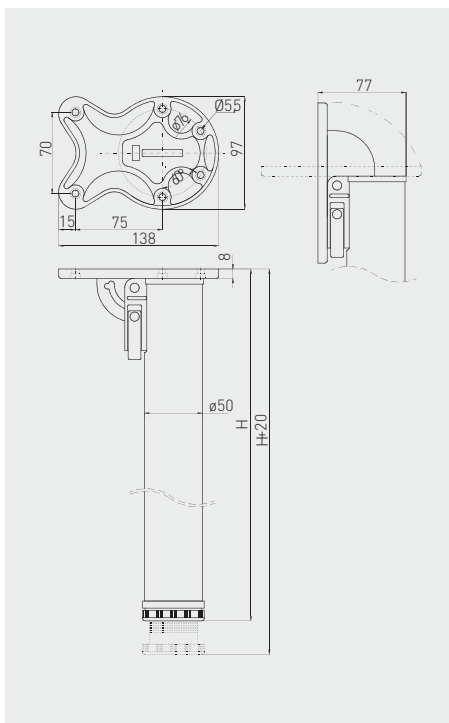



		 H mm		
NM-F50710-01	710 + 20		chrom / chrome / хром	ZnAl, stal, ABS ZnAl, steel, ABS ZnAl, сталь, ABS
NM-F50710-06			stal szczotkowana / brushed steel / шлифованная сталь	
NM-F50710-10			biały / white / белый	
NM-F50710-20			czarny / black / чёрный	
NM-F50870-01	870 + 20		chrom / chrome / хром	
NM-F50870-06			stal szczotkowana / brushed steel / шлифованная сталь	
NM-F50870-10			biały / white / белый	
NM-F50870-20			czarny / black / чёрный	

* Dostępny na zamówienie / Available only for individual order / Доступен под заказ

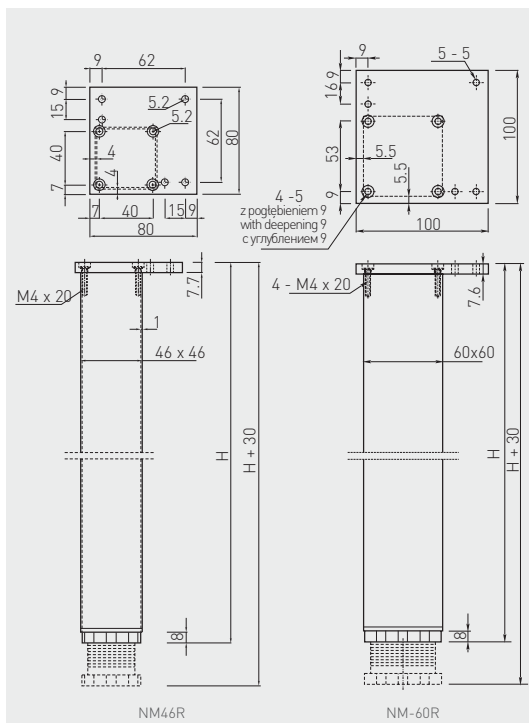
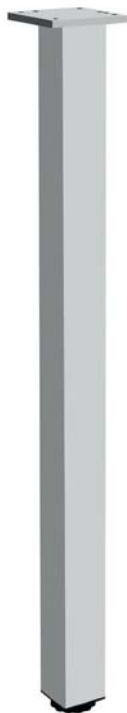
Noga kwadratowa z regulacją
 Square furniture leg
 Мебельная опора с регулировкой







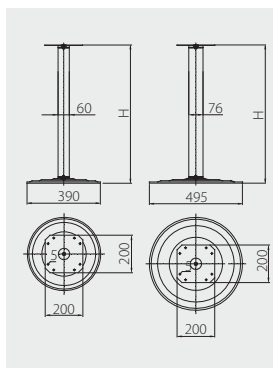

	 H mm		
NM-46R710-05	710 + 30	aluminium / aluminium / алюминий	
NM-46R820-05	820 + 30		
NM-60R710-05	710 + 30		
NM-60R820-05	820 + 30		
NM-60R710-06*	710 + 30	stal szczotkowana / brushed steel / шлифованная сталь	aluminium aluminium алюминий
NM-60R710-20*		czarny / black / чёрный	
NM-60R1100-05*	1100 + 30	aluminium / aluminium / алюминий	
NM-60R1100-06*		stal szczotkowana / brushed steel / шлифованная сталь	
NM-60R1100-20*		czarny / black / чёрный	

* Dostępna na zamówienie / Available only for individual order / Доступен под заказ

* Na indywidualne zamówienie dostępna w wysokości 1100 mm / For special orders 1100 mm height also available
 Под заказ доступна также с высотой 1100 мм

Noga barowa
Bar leg
Барная опора



	 H mm	 mm		
NM-380X730-01	735	60	chrom / chrome / хром	stal / steel / сталь
NM-480X730-01	735	76		



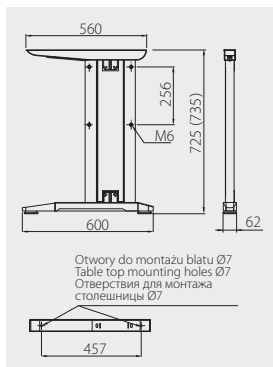



Stelaż biurkowy
Metal frames for desk
Металлический каркас для стола

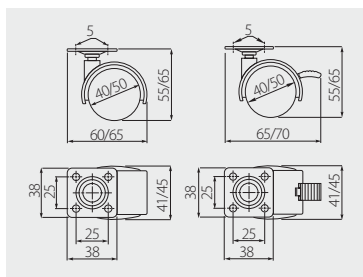

	 H mm		
SB-A60X72-80	725 (735)	srebrny / silver / серебристый	stal / steel / сталь





Rolka KM-D20
Furniture caster KM-D20
Колёсики KM-D20

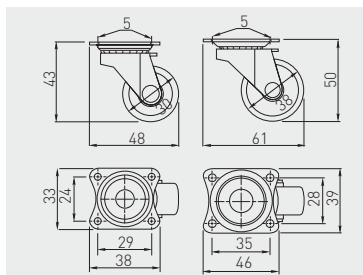

		 mm	 kg		
KM-00-40-D20	bez hamulca without break без стопора	40	18	czarny black чёрный	plastik plastic пластмасса
KM-00-50-D20		50	22		
KM-0H-40-D20	z hamulcem with break со стопором	40	18		
KM-0H-50-D20		50	22		

Rolka KM 15 plastikowa
Furniture caster KM 15 plastic
Пластиковые колёсики KM 15



	 mm	 kg		
KM-015030-10	30	13,5	biały / white / белый	plastik plastic пластмасса
KM-015030-20			czarny / black / чёрный	
KM-015038-10	38	16	biały / white / белый	



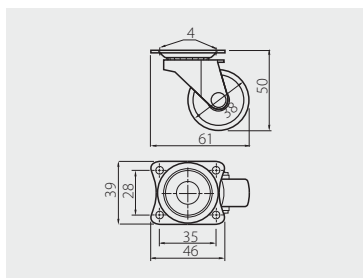



Rolka KM 15 gumowa
 Rubber furniture caster KM 15
 Резиновые колёсики KM 15

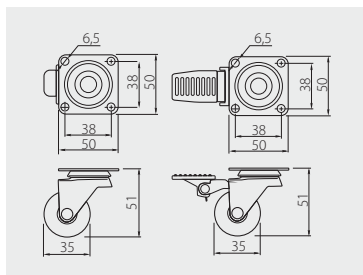

	 mm	 kg		
KM-015038-GM	38	16	czarny / black / чёрный	guma / rubber / резина





Rolka KMA 35
 Furniture caster KMA 35
 Колёсики KMA 35

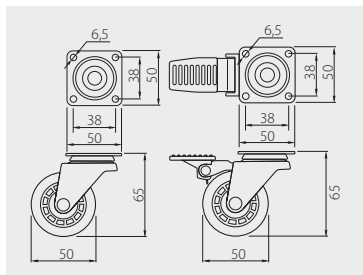

		 mm	 kg		
KM-A035MM-00	bez hamulca without break без стопора	35	25	przeźroczysty / transparent / прозрачный	PC / PU
KM-A035MM-30				brązowy / brown / коричневый	
KM-AH35MM-00	z hamulcem with break со стопором			przeźroczysty / transparent / прозрачный	
KM-AH35MM-30				brązowy / brown / коричневый	





Rolka KMA 50
Furniture caster KMA 50
Колёсики KMA 50

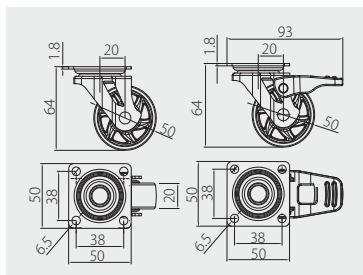

					
KM-A050MM-00	bez hamulca without break без стопора	50	35	przeźroczysty / transparent / прозрачный	PC / PU
KM-A050MM-30				brąz / brown / коричневый	
KM-AH50MM-00	z hamulcem with break со стопором			przeźroczysty / transparent / прозрачный	
KM-AH50MM-30				brąz / brown / коричневый	

Rolka SHIFT 50
Furniture caster SHIFT 50
Колёсики SHIFT 50







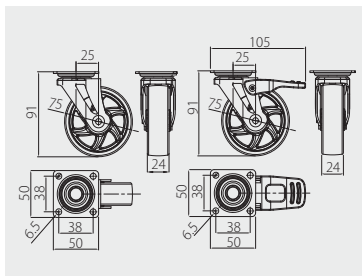

					
KM-B050MM-00	bez hamulca without break без стопора	50	30	przeźroczysty / transparent / прозрачный	PC / PU
KM-B050MM-30				brąz / brown / коричневый	
KM-BH50MM-00	z hamulcem with break со стопором			przeźroczysty / transparent / прозрачный	
KM-BH50MM-30				brąz / brown / коричневый	

Rolka SHIFT 75

Furniture caster SHIFT 75

Колёсики SHIFT 75







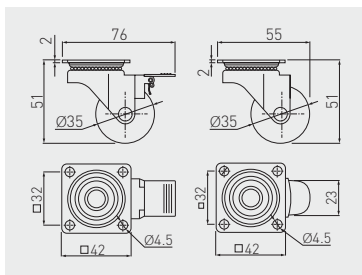

					
KM-B075MM-00	bez hamulca without break	75	40	przeźroczysty / transparent / прозрачный	PC / PU
KM-B075MM-30	bez stopora без стопора			brąz / brown / коричневый	
KM-BH75MM-00	z hamulcem with break			przeźroczysty / transparent / прозрачный	
KM-BH75MM-30	z hamulcem with break со стопором			brąz / brown / коричневый	

Rolka BRAZYLIA 35

Furniture caster BRAZYLIA 35





Колёсики BRAZYLIA 35

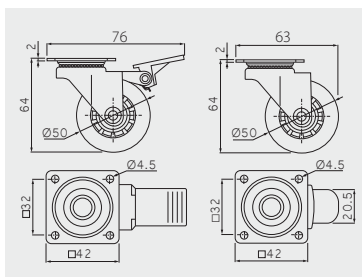

					
KM-RD-35-SF	bez hamulca without break	35	30	przeźroczysty / transparent / прозрачный	PC, PU
KM-RD-35-SF-20	bez stopora без стопора			czarny / black / чёрный	
KM-RD-35-CF	z hamulcem with break			przeźroczysty / transparent / прозрачный	
KM-RD-35-CF-20	z hamulcem with break со стопором			czarny / black / чёрный	





Rolka BRAZYLIA 50
Furniture caster BRAZYLIA 50
Колёсики BRAZYLIA 50

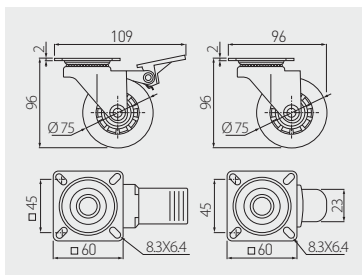

					
KM-RD-50-SF	bez hamulca without break	50	40	przeźroczysty / transparent / прозрачный	PC, PU
KM-RD-50-SF-20	bez stopora			czarny / black / чёрный	
KM-RD-50-CF	z hamulcem with break			przeźroczysty / transparent / прозрачный	
KM-RD-50-CF-20	co stoporem			czarny / black / чёрный	

Rolka BRAZYLIA 75
Furniture caster BRAZYLIA 75
Колёсики BRAZYLIA 75



					
KM-RD-75-SF	bez hamulca without break	75	64	przeźroczysty / transparent / прозрачный	PC, PU
KM-RD-75-SF-20	bez stopora			czarny / black / чёрный	
KM-RD-75-CF	z hamulcem with break			przeźroczysty / transparent / прозрачный	
KM-RD-75-CF-20	co stoporem			czarny / black / чёрный	

Zamek K-138
Lock K-138
Замок K-138

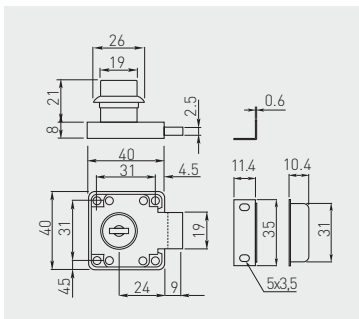

ZZ-KM-138-01



chrom / chrome / хром



ZnAl, stal / ZnAl, steel / ZnAl, сталь

Zamek Z-138 z kluczem łamanym
Lock Z-138 with folding key
Замок Z-138 со складным ключом

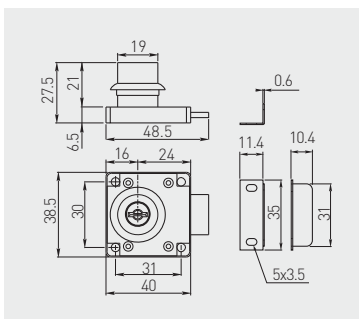

ZZ-ZN-138-01



chrom / chrome / хром



ZnAl, stal / ZnAl, steel / ZnAl, сталь

Zamek C-138 z kluczem cyfrowym
 Lock C-138 with key
 Замок C-138 с цифровым ключом

Kompatybilny z kluczem MASTER
 Compatible with MASTER key
 Подходит для ключа MASTER

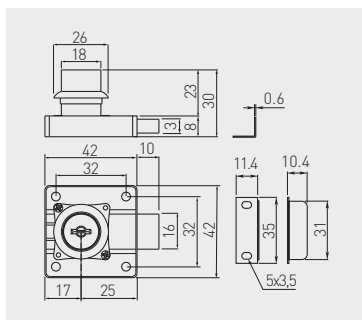

ZZ-CF-138-01



chrom / chrome / хром



ZnAl, stal / ZnAl, steel / ZnAl, сталь

Klucz MASTER do zamka C-138
 MASTER key for C-138 lock
 Ключ MASTER к замку C-138



ZZ-KLMASTER



chrom / chrome / хром



ZnAl, stal / ZnAl, steel / ZnAl, сталь

Zamek Z-338 zatrzaskowy
 Square lock Z-338
 Замок Z-338 с защёлкой

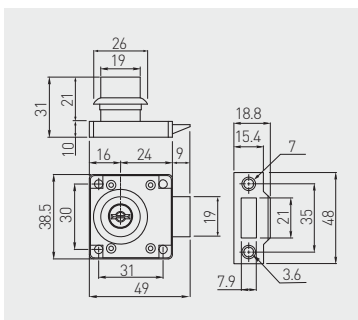

ZZ-ZN-338-01



chrom / chrome / хром



ZnAl, stal / ZnAl, steel / ZnAl, сталь

Zamek B-105 bolcowy
 Pin lock B-105
 Замок B-105 кнопочный

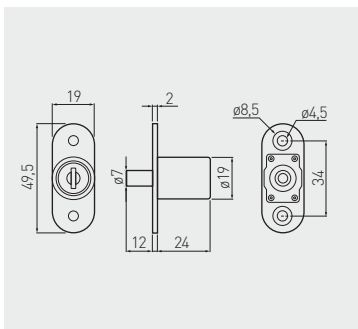

ZZ-B0-105-01





chrom / chrome / хром

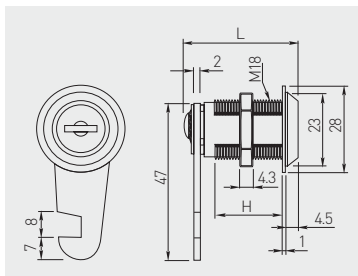

ZnAl, stal / ZnAl, steel / ZnAl, сталь

Zamek Z-103 skrzynkowy
Box lock Z-103
Замок Z-103



		 L mm	 H mm		
ZZ-16-103-01		27	12	chrom / chrome / хром	ZnAl, stal / ZnAl, steel / ZnAl, сталь
ZZ-20-103-01		30	16,5		
ZZ-30-103-01		40	26,5		

Zamek S-407 do szyby
Glass door lock S-407
Замок S-407 для стеклянной распашной двери

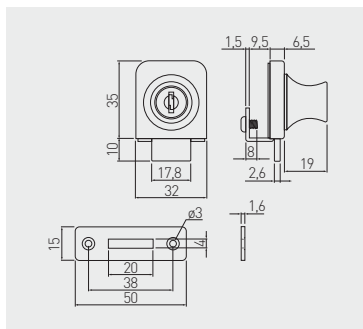

			
ZZ-SZ-407-01		chrom / chrome / хром	ZnAl, stal / ZnAl, steel / ZnAl, сталь

Zamek S-408 do szyb
Glass door lock S-408
Замок S-408 для стеклянных дверей

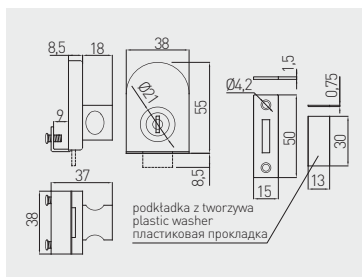

Zastosowanie do szkła 4 - 8 mm
For 4 - 8 mm glass
Толщина стекла 4-8 мм



ZZ-SZ-408-01



chrom / chrome / хром



ZnAl, stal / ZnAl, steel / ZnAl, сталь

Zamek S-409 do szyb
Glass door lock S-409
Замок S-409 для стеклянных дверей

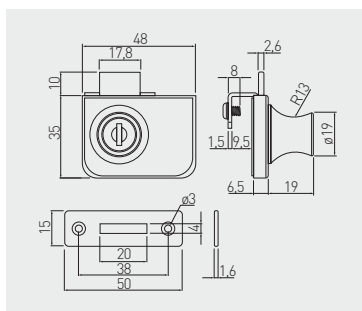

Zastosowanie do szkła 4 - 8 mm
For 4 - 8 mm glass
Толщина стекла 4-8 мм



ZZ-SZ-409-01



chrom / chrome / хром



ZnAl, stal / ZnAl, steel / ZnAl, сталь

Zamek M-201
Lock M-201
Замок M-201

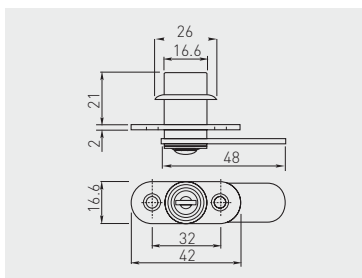

ZZ-M0-201-01



chrom / chrome / хром



ZnAl, stal / ZnAl, steel / ZnAl, сталь

Zamek Z-202 żaluzjowy
Double hook lock Z-202
Замок Z-202 жалюзийный

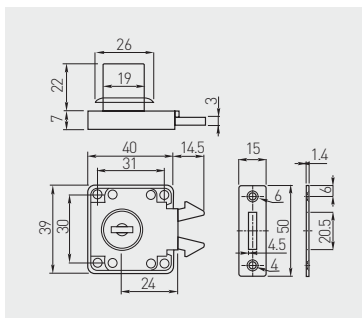

ZZ-Z0-202-01



chrom / chrome / хром



ZnAl, stal / ZnAl, steel / ZnAl, сталь

Zamek G-328 grzbietowy
Sliding glass door lock G-328
Замок G-328 внутренний

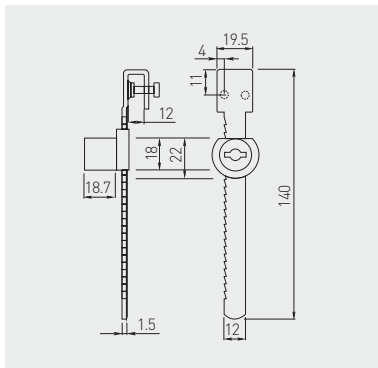

Zastosowanie do szkła 4 - 8 mm
For 4 - 8 mm glass
Толщина стекла 4 - 8 мм



ZZ-G0-328-01

chrom / chrome / хром

ZnAl, stal / ZnAl, steel / ZnAl, сталь

Zamek baskwilowy
Espagnolette lock
Замок шпингалетный

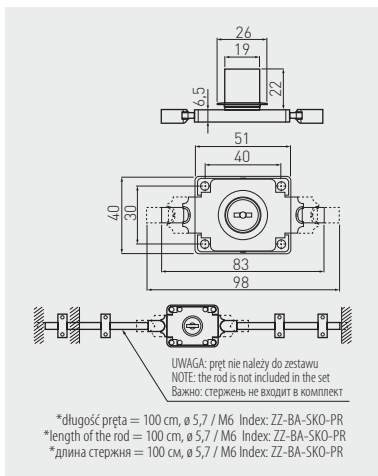

ZZ-BA-SK0-01

chrom / chrome / хром

ZnAl, stal / ZnAl, steel / ZnAl, сталь

Zamek C-288 centralny
Cabinet drawer lock C-288
Замок C-288 центральный боковой

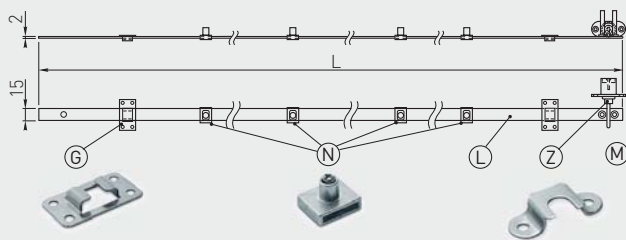



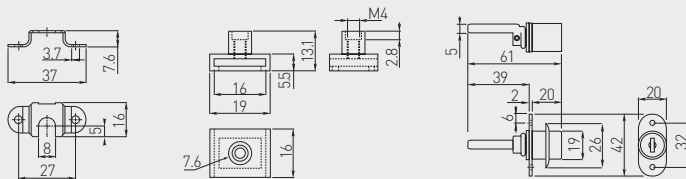

Skład zestawu / Set includes / Состав набора:

- Ⓒ Mocowanie listwy / Slat fixing / Крепление планки
- Ⓓ Blokady szuflady / Drawer locking mechanism / Блокада ящика
- Ⓕ Listwa zamka / Lock slot / Планка замка
- Ⓖ Zamek / Lock / Замок
- Ⓜ Zaczep / Hook / Зацепка

Model	C5	C6	C8	C1
L	500	600	800	1200
N	3	3	4	4
M	3	3	4	4
G	2	2	3	3



		 mm		
ZZ-C5-288-01		500	chrom / chrome / хром	ZnAl, stal / ZnAl, steel / ZnAl, сталь
ZZ-C6-288-01		600		
ZZ-C8-288-01		800		
ZZ-C1-288-01		1200		

**SYSTEMY PRZESUWNE
SLIDING DOOR SYSTEMS
РАЗДВИЖНЫЕ СИСТЕМЫ**

Dolny układ jezdny
Bottom-running systems
Нижняя ходовая система

432 – 462

Górny układ jezdny
Top-running systems
Верхняя ходовая система





463 – 467



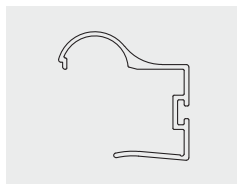

Rączka ERGO
Handle ERGO
Ручка ERGO



			
A-R18ERG-270-05	2700	aluminium / aluminium / алюминий	aluminium aluminium алюминий
A-R18ERG-270-90		szampan / champagne / шампань	



Rączka ERGO 16
Handle ERGO 16
Ручка ERGO 16

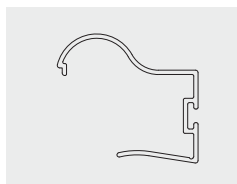

			
A-R16ERG-270-50	2700	aluminium / aluminium / алюминий	aluminium / aluminium / алюминий



Rączka GEO 18
Handle GEO 18
Ручка GEO 18

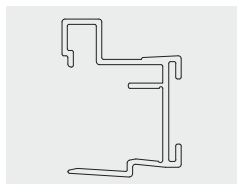

			
A-R18GEO2-270-05	2700	aluminium / aluminium / алюминий	aluminium / aluminium / алюминий



Rączka RIVA
Handle RIVA
Ручка RIVA

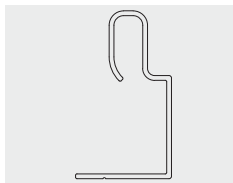

A-SN-R19RIV-270-05

2700

aluminium / aluminium / алюминий

aluminium / aluminium / алюминий



Rączka NOVO 2
Handle NOVO 2
Ручка NOVO 2

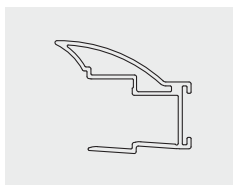

A-RNOV2-270-05

A-RNOV2-270-10

A-RNOV2-270-90

2700

aluminium / aluminium / алюминий

biały / white / белый

szampan / champagne / шампань

aluminium
aluminium
алюминий



Rączka NOVO S
Handle NOVO S
Ручка NOVO S

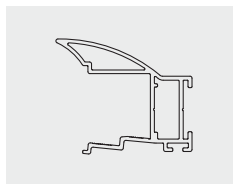

A-R18NOVS-270-05

A-R18NOVS-270-10

A-R18NOVS-270-20M

A-R18NOVS-270-90

2700

aluminium / aluminium / алюминий

biały / white / белый

czarny / black / чёрный

szampan / champagne / шампань

aluminium
aluminium
алюминий



Rączka NOVO S 19/4 mm
 Handle NOVO S 19/4 mm
 Ручка NOVO S 19/4 mm

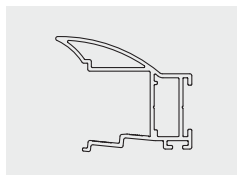

	 L mm		
A-R19NOVS-300-05	3000	aluminium / aluminium / алюминий	aluminium / aluminium / алюминий
 BOARD 19 mm	 BOARD 16 mm	 GLASS 4 mm	 FRAME
 FRAMELESS	 × 24		

Rączka CARO
 Handle CARO
 Ручка CARO

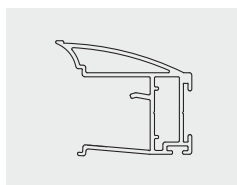

	 L mm		
A-R18CARO-270-05	2700	aluminium / aluminium / алюминий	aluminium aluminium алюминий
A-R18CARO-270-90		szampan / champagne / шампань	
 BOARD 18 mm	 GLASS 4 mm	 FRAME	 FRAMELESS
		 × 20	

Rączka VISTA
 Handle VISTA
 Ручка VISTA

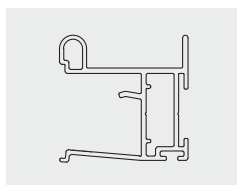

	 L mm		
A-R18VIS-270-05	2700	aluminium / aluminium / алюминий	aluminium aluminium алюминий
A-R18VIS-270-90		szampan / champagne / шампань	
 BOARD 18 mm	 GLASS 4 mm	 FRAME	 FRAMELESS
		 × 24	

Rączka NERO
Handle NERO
Ручка NERO

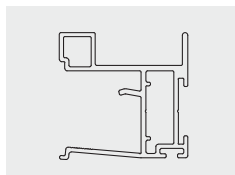

	 L mm		
A-R18NERO-270-05	2700	aluminium / aluminium / алюминий	aluminium aluminium алюминий
A-R18NERO-270-10		biały / white / белый	
A-R18NERO-270-20M		czarny / black / чёрный	
A-R18NERO-270-90		szampan / champagne / шампань	

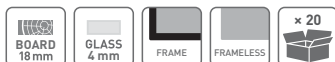

Rączka NERO 19/4 mm
Handle NERO 19/4 mm
Ручка NERO 19/4 mm

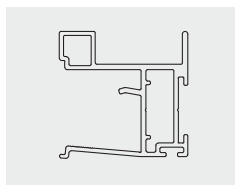





	 L mm		
A-R19NERO-300-05	3000	aluminium / aluminium / алюминий	aluminium / aluminium / алюминий

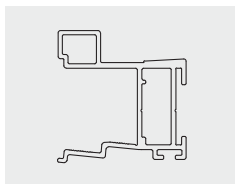

Rączka COTE
Handle COTE
Ручка COTE







	 L mm		
A-R18COTE-270-05	2700	aluminium / aluminium / алюминий	aluminium aluminium алюминий
A-R18COTE-270-90		szampan / champagne / шампань	

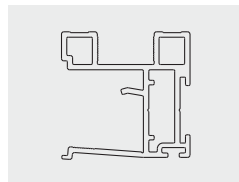

Rączka LOCA
Handle LOCA
Ручка LOCA







	 L mm		
A-R18LOCA-305-05	3050	aluminium / aluminium / алюминий	aluminium aluminium алюминий
A-R18LOCA-305-90		szampan / champagne / шампань	

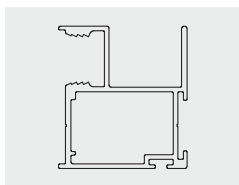

Rączka FLAT LINE
Handle FLAT LINE
Ручка FLAT LINE



	 L mm		
A-R10FL-270-05	2700	aluminium / aluminium / алюминий	aluminium aluminium алюминий
A-R10FL-270-10		biały / white / белый	
A-R10FL-270-90		szampan / champagne / шампань	



Rączka MOVENA
Handle MOVENA
Ручка MOVENA



NEW

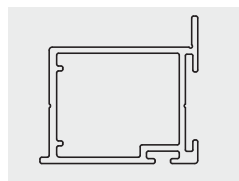





	 L mm		
A-R4MOV-270-05	2700	aluminium / aluminium / алюминий	aluminium aluminium алюминий

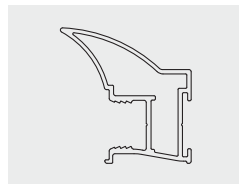

Rączka NOVO 10
Handle NOVO 10
Ручка NOVO 10



	 L mm		
A-R10NOV-270-05	2700	aluminium / aluminium / алюминий	aluminium aluminium алюминий
A-R10NOV-270-10		biały / white / белый	
A-R10NOV-270-90		szampan / champagne / шампань	



Rączka FORM
Handle FORM
Ручка FORM

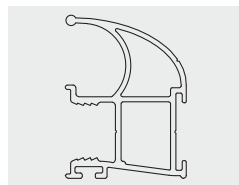





	 L mm		
A-R10FORM-270-05	2700	aluminium / aluminium / алюминий	aluminium aluminium алюминий
A-R10FORM-270-90		biały / white / белый	



Rączka TRAF0
Handle TRAF0
Ручка TRAF0







	 L mm		
A-R10TRAF0-270-05	2700	aluminium / aluminium / алюминий	aluminium aluminium алюминий
A-R10TRAF0-270-90		szampan / champagne / шампань	

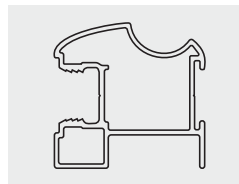

Rączka TORO
Handle TORO
Ручка TORO







		 L mm		
A-R10TORO-270-05		2700	aluminium / aluminium / алюминий	aluminium aluminium алюминий
A-R10TORO-270-90			szampan / champagne / шампань	

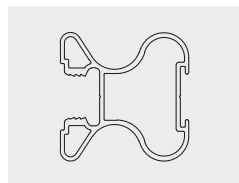

Rączka FALDA
Handle FALDA
Ручка FALDA







		 L mm		
A-R10FALDA-270-05		2700	aluminium / aluminium / алюминий	aluminium aluminium алюминий
A-R10FALDA-270-90			szampan / champagne / шампань	

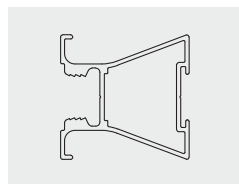

Rączka ARCO
Handle ARCO
Ручка ARCO







		 L mm		
A-R10ARCO-270-05		2700	aluminium / aluminium / алюминий	aluminium aluminium алюминий
A-R10ARCO-270-90			szampan / champagne / шампань	



Tor górny
Top track
Верхняя направляющая



	 L mm		
A-TG-170-05	1700	aluminium / aluminium / алюминий	 aluminium aluminium алюминий
A-TG-170-90		szampan / champagne / шампань	
A-TG-235-05	2350	aluminium / aluminium / алюминий	
A-TG-235-90		szampan / champagne / шампань	
A-TG-300-05	3000	aluminium / aluminium / алюминий	
A-TG-300-10		biały / white / белый	
A-TG-300-20M		czarny / black / чёрный	
A-TG-300-90		szampan / champagne / шампань	
A-TG-405-05	4050	aluminium / aluminium / алюминий	
A-TG-405-10		biały / white / белый	
A-TG-405-90		szampan / champagne / шампань	
A-TG-600-05	6000	aluminium / aluminium / алюминий	
A-TG-600-10		biały / white / белый	
A-TG-600-90		szampan / champagne / шампань	



Tor dolny EVO Bottom track EVO Нижняя направляющая EVO



	 L mm		
A-TDEVO-170-05	1700	aluminium / aluminium / алюминий	aluminium aluminium алюминий
A-TDEVO-170-10		biały / white / белый	
A-TDEVO-170-20M		czarny / black / чёрный	
A-TDEVO-170-90		szampan / champagne / шампань	
A-TDEVO-235-05	2350	aluminium / aluminium / алюминий	
A-TDEVO-235-10		biały / white / белый	
A-TDEVO-235-20M		czarny / black / чёрный	
A-TDEVO-235-90		szampan / champagne / шампань	
A-TDEVO-300-05	3000	aluminium / aluminium / алюминий	
A-TDEVO-300-10		biały / white / белый	
A-TDEVO-300-20M		czarny / black / чёрный	
A-TDEVO-300-90		szampan / champagne / шампань	
A-TDEVO-405-05	4050	aluminium / aluminium / алюминий	
A-TDEVO-405-10		biały / white / белый	
A-TDEVO-405-20M		czarny / black / чёрный	
A-TDEVO-405-90		szampan / champagne / шампань	
A-TDEVO-600-05	6000	aluminium / aluminium / алюминий	
A-TDEVO-600-10		biały / white / белый	
A-TDEVO-600-20M		czarny / black / чёрный	
A-TDEVO-600-90		szampan / champagne / шампань	



Maskownica EVO Masking cover EVO Декоративная накладка







	 L mm		
A-MEVO-170-05	1700	aluminium / aluminium / алюминий	aluminium aluminium алюминий
A-MEVO-170-10A		biały / white / белый	
A-MEVO-170-90		szampan / champagne / шампань	
A-MEVO-170-20M		czarny / black / чёрный	
A-MEVO-235-05	2350	aluminium / aluminium / алюминий	
A-MEVO-235-10A		biały / white / белый	
A-MEVO-235-90		szampan / champagne / шампань	
A-MEVO-235-20M		czarny / black / чёрный	
A-MEVO-300-05	3000	aluminium / aluminium / алюминий	
A-MEVO-300-10A		biały / white / белый	
A-MEVO-300-20M		czarny / black / чёрный	
A-MEVO-300-90		szampan / champagne / шампань	
A-MEVO-405-05	4050	aluminium / aluminium / алюминий	
A-MEVO-405-10		biały / white / белый	
A-MEVO-405-90		szampan / champagne / шампань	
A-MEVO-405-20M		czarny / black / чёрный	



Tor dolny EVO 2
Bottom track EVO 2
Нижняя направляющая EVO 2



	 L mm		
A-TDEVO2-170-05	1700	aluminium / aluminium / алюминий	aluminium aluminium алюминий
A-TDEVO2-170-90		szampan / champagne / шампань	
A-TDEVO2-235-05	2350	aluminium / aluminium / алюминий	
A-TDEVO2-235-90		szampan / champagne / шампань	
A-TDEVO2-300-05	3000	aluminium / aluminium / алюминий	
A-TDEVO2-300-90		szampan / champagne / шампань	
A-TDEVO2-405-05	4050	aluminium / aluminium / алюминий	
A-TDEVO2-405-90		szampan / champagne / шампань	
A-TDEVO2-600-05	6000	aluminium / aluminium / алюминий	
A-TDEVO2-600-90		szampan / champagne / шампань	



Tor dolny PRO
Bottom track PRO
Нижняя направляющая PRO



	 L mm		
A-TDPRO-170-05	1700	aluminium / aluminium / алюминий	aluminium aluminium алюминий
A-TDPRO-170-10		biały / white / белый	
A-TDPRO-170-20M		czarny / black / чёрный	
A-TDPRO-170-90		szampan / champagne / шампань	
A-TDPRO-235-05	2350	aluminium / aluminium / алюминий	
A-TDPRO-235-10		biały / white / белый	
A-TDPRO-235-20M		czarny / black / чёрный	
A-TDPRO-235-90		szampan / champagne / шампань	
A-TDPRO-300-05	3000	aluminium / aluminium / алюминий	
A-TDPRO-300-10		biały / white / белый	
A-TDPRO-300-20M		czarny / black / чёрный	
A-TDPRO-300-90		szampan / champagne / шампань	
A-TDPRO-405-05	4050	aluminium / aluminium / алюминий	
A-TDPRO-405-10		biały / white / белый	
A-TDPRO-405-20M		czarny / black / чёрный	
A-TDPRO-405-90		szampan / champagne / шампань	
A-TDPRO-600-05	6000	aluminium / aluminium / алюминий	
A-TDPRO-600-10		biały / white / белый	
A-TDPRO-600-10		biały / white / белый	
A-TDPRO-600-90		szampan / champagne / шампань	



Maskownica PRO Masking cover PRO Декоративная накладка PRO



	 L mm		
A-MPRO-170-05	1700	aluminium / aluminium / алюминий	aluminium aluminium алюминий
A-MPRO-170-10		biały / white / белый	
A-MPRO-170-20M		czarny / black / чёрный	
A-MPRO-170-90		szampan / champagne / шампань	
A-MPRO-235-05	2350	aluminium / aluminium / алюминий	
A-MPRO-235-10		biały / white / белый	
A-MPRO-235-20M		czarny / black / чёрный	
A-MPRO-235-90		szampan / champagne / шампань	
A-MPRO-300-05	3000	aluminium / aluminium / алюминий	
A-MPRO-300-10		biały / white / белый	
A-MPRO-300-20M		czarny / black / чёрный	
A-MPRO-300-90		szampan / champagne / шампань	
A-MPRO-405-05	4050	aluminium / aluminium / алюминий	
A-MPRO-405-10		biały / white / белый	
A-MPRO-405-20M		czarny / black / чёрный	
A-MPRO-405-90		szampan / champagne / шампань	



Listwa górna 18/4 mm Top strip 18/4 mm Профиль горизонтальный верхний 18/4 мм





	 L mm		
A-LG18-170-05	1700	aluminium / aluminium / алюминий	aluminium aluminium алюминий
A-LG18-170-90		szampan / champagne / шампань	
A-LG18-235-05	2350	aluminium / aluminium / алюминий	
A-LG18-235-90		szampan / champagne / шампань	
A-LG18-300-05	3000	aluminium / aluminium / алюминий	
A-LG18-300-10		biały / white / белый	
A-LG18-300-20M		czarny / black / чёрный	
A-LG18-300-90		szampan / champagne / шампань	
A-LG18-405-05	4050	aluminium / aluminium / алюминий	
A-LG18-405-10		biały / white / белый	
A-LG18-405-90		szampan / champagne / шампань	
A-LG18-600-05	6000	aluminium / aluminium / алюминий	
A-LG18-600-90		szampan / champagne / шампань	



Listwa dolna 18/4 mm
Bottom strip 18/4 mm
Профиль горизонтальный нижний 18/4 мм



	 L mm		
A-LD18-170-05	1700	aluminium / aluminium / алюминий	aluminium aluminium алюминий
A-LD18-170-90		szampan / champagne / шампань	
A-LD18-235-05	2350	aluminium / aluminium / алюминий	
A-LD18-235-90		szampan / champagne / шампань	
A-LD18-300-05	3000	aluminium / aluminium / алюминий	
A-LD18-300-10		biały / white / белый	
A-LD18-300-20M		czarny / black / чёрный	
A-LD18-300-90		szampan / champagne / шампань	
A-LD18-405-05	4050	aluminium / aluminium / алюминий	
A-LD18-405-10		biały / white / белый	
A-LD18-405-90		szampan / champagne / шампань	
A-LD18-600-05	6000	aluminium / aluminium / алюминий	
A-LD18-600-90		szampan / champagne / шампань	



Listwa górna 19/4 mm
Top strip 19/4 mm
Профиль горизонтальный верхний 19/4 мм



	 L mm		
A-LG19-300-05	3000	aluminium aluminium алюминий	aluminium aluminium алюминий



Listwa dolna 19/4 mm
Bottom strip 19/4 mm
Профиль горизонтальный нижний 19/4 мм







			
A-LD19-300-05	3000	aluminium aluminium алюминий	aluminium aluminium алюминий



Listwa górna 10/4 mm
Top strip 10/4 mm
Профиль горизонтальный верхний 10/4 мм







			
A-LG10-170-05	1700	aluminium / aluminium / алюминий	aluminium aluminium алюминий
A-LG10-235-05	2350	aluminium / aluminium / алюминий	
A-LG10-235-90		szampan / champagne / шампань	
A-LG10-300-05	3000	aluminium / aluminium / алюминий	
A-LG10-300-10		biały / white / белый	
A-LG10-300-90		szampan / champagne / шампань	
A-LG10-405-05	4050	aluminium / aluminium / алюминий	
A-LG10-405-90		szampan / champagne / шампань	
A-LG10-600-05	6000	aluminium / aluminium / алюминий	
A-LG10-600-90		szampan / champagne / шампань	



Listwa dolna 10/4 mm
Bottom strip 10/4 mm
Профиль горизонтальный нижний 10/4 мм



	 L mm		
A-LD10-170-05	1700	aluminium / aluminium / алюминий	aluminium aluminium алюминий
A-LD10-235-05	2350	aluminium / aluminium / алюминий	
A-LD10-235-90		szampan / champagne / шампань	
A-LD10-300-05	3000	aluminium / aluminium / алюминий	
A-LD10-300-10		biały / white / белый	
A-LD10-300-90		szampan / champagne / шампань	
A-LD10-405-05	4050	aluminium / aluminium / алюминий	
A-LD10-405-90		szampan / champagne / шампань	
A-LD10-600-05	6000	aluminium / aluminium / алюминий	
A-LD10-600-90		szampan / champagne / шампань	



Listwa górna 4 mm
Top strip 4 mm
Профиль горизонтальный верхний 4 мм

NEW



	 L mm		
A-LG4MOV-300-05	3000	biały / white / белый	aluminium aluminium алюминий



Listwa dolna 4 mm
Bottom strip 4 mm
Профиль горизонтальный нижний 4 мм







	 L mm		
A-LD4MOV-300-05	3000	biały / white / белый	aluminium aluminium алюминий



Listwa górna FL 10/4 mm
Top strip FL 10/4 mm
Профиль горизонтальный верхний FL 10/4 мм







	 L mm		
A-LG10FL-235-05	2350	aluminium / aluminium / алюминий	aluminium aluminium алюминий
A-LG10FL-235-90		szampan / champagne / шампань	
A-LG10FL-300-05	3000	aluminium / aluminium / алюминий	
A-LG10FL-300-10		biały / white / белый	
A-LG10FL-300-90		szampan / champagne / шампань	



Listwa dolna FL 10 / 4 mm
 Bottom strip FL 10/4 mm
 Профиль горизонтальный нижний FL 10/4 мм



	 L mm		
A-LD10FL-235-05	2350	aluminium / aluminium / алюминий	aluminium aluminium алюминий
A-LD10FL-235-90		szampan / champagne / шампань	
A-LD10FL-300-05	3000	aluminium / aluminium / алюминий	
A-LD10FL-300-10		biały / white / белый	
A-LD10FL-300-90		szampan / champagne / шампань	



Kątownik
 Angle bar
 Профиль угловой







	 L mm		
A-K18-300-05	3000	aluminium / aluminium / алюминий	aluminium aluminium алюминий
A-K18-300-10		biały / white / белый	
A-K18-300-20M		czarny / black / чёрный	
A-K18-300-90		szampan / champagne / шампань	



Profil C18
Profile C18
Профиль C18







	 L mm		
A-C18-300-S-05	3000	aluminium / aluminium / алюминий	aluminium aluminium алюминий
A-C18-300-S-10		biały / white / белый	
A-C18-300-S-20M		czarny mat / black matt / чёрный матовый	
A-C18-300-S-90		szampan / champagne / шампань	



Profil T18
Profile T18
Профиль T18





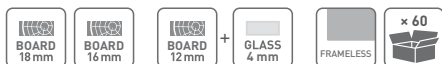

	 L mm		
A-T18-300-05	3000	aluminium / aluminium / алюминий	aluminium aluminium алюминий
A-T18-300-10		biały / white / белый	
A-T18-300-90		szampan / champagne / шампань	



Profil H16
Profile H16
Профиль H16



	 L mm		
A-H16-300-05	3000	aluminium / aluminium / алюминий	aluminium aluminium алюминий
A-H16-300-90		szampan / champagne / шампань	





Profil H18
Profile H18
Профиль H18







	 L mm		
A-H18-300-05	3000	aluminium / aluminium / алюминий	aluminium aluminium алюминий
A-H18-300-10		biały / white / белый	
A-H18-300-20M		czarny / black / чёрный	
A-H18-300-90		szampan / champagne / шампань	



Profil HR18
Profile HR18
Профиль HR18







	 L mm		
A-HR18-300-05	3000	aluminium / aluminium / алюминий	aluminium aluminium алюминий
A-HR18-300-10		biały / white / белый	
A-HR18-300-20M		czarny / black / чёрный	
A-HR18-300-90		szampan / champagne / шампань	



Profil HRS18
Profile HRS18
Профиль HRS18



NEW

	 L mm		
A-HRS18-300-05	3000	aluminium / aluminium / алюминий	aluminium aluminium алюминий
A-HRS18-300-90		szampan / champagne / шампань	
A-HRS18-235-05	2350	aluminium / aluminium / алюминий	



Profil HR19
Profile HR19
Профиль HR19



A-HR19-300-05	3000	aluminium / aluminium / алюминий	aluminium / aluminium / алюминий
---------------	------	----------------------------------	----------------------------------



Profil HR10
Profile HR10
Профиль HR10



NEW



A-HR10-235-05	2350	aluminium / aluminium / алюминий	aluminium aluminium алюминий
A-HR10-300-10	3000	biały / white / белый	
A-HR10-300-90		aluminium / aluminium / алюминий	
A-HR10-600-05	6000	szampan / champagne / шампань	
A-HR10-600-90			



Profil HRS10
Profile HRS10
Профиль HRS10

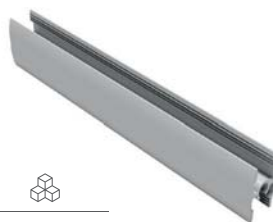





A-HRS10-170-05	1700	aluminium / aluminium / алюминий	aluminium aluminium алюминий
A-HRS10-300-05	3000		
A-HRS10-300-90		szampan / champagne / шампань	
A-HRS10-405-05	4050	aluminium / aluminium / алюминий	
A-HRS10-600-05	6000		



Profil HR10 FL
Profile HR10 FL
Профиль HR10 FL





	 mm		
A-HR10FL-300-05	3000	aluminium / aluminium / алюминий	aluminium aluminium алюминий
A-HR10FL-300-10		biały / white / белый	
A-HR10FL-300-90		szampań / champagne / шампань	



Prowadnik górny PG-18
Top roller PG-18
Верхний ролик PG-18





	 kg	
A-PG-18	50	stal, tworzywo steel, plastic сталь, пластмасса





Prowadnik górny PGR-18
Top roller PGR-18
Верхний ролик PGR-18



	 kg	
A-PGR-18	50	stal, tworzywo steel, plastic сталь, пластмасса





Prowadnik górny PGR-10
Top roller PGR-10
Верхний ролик PGR-10

		
A-PGR-10	50	stal, tworzywo steel, plastic сталь, пластмасса





Prowadnik górny PGR-10 symetryczny
Top roller PGR-10 symmetrical
Верхний ролик PGR-10 симметричный

		
A-PGR-10S	50	stal, tworzywo steel, plastic сталь, пластмасса





Płytk dystansowa
Spacer plate
Распорная пластина

		
A-DPG-16	50	stal steel сталь





Wózek dolny EVO Bottom roller EVO Нижний ролик EVO

		
A-WD-EVO	50	stal, tworzywo steel, plastic сталь, пластмасса





Wózek dolny EVO 2 Bottom roller EVO 2 Нижний ролик EVO 2

		
A-WD-EVO2	50	stal, tworzywo steel, plastic сталь, пластмасса



NEW



Zaczer EVO 2 Hook EVO 2 Зацепка EVO 2

		
A-ZAC-WDEV02	50	stal, tworzywo steel, plastic сталь, пластмасса



NEW



Wózek dolny PRO Bottom roller PRO Нижний ролик PRO

		
A-WD-PRO	50	stal, tworzywo steel, plastic сталь, пластмасса



Wózek dolny EVO rama
Bottom roller EVO frame
Нижний ролик EVO для рамной системы





		
A-WDR-EVO	50	stal, tworzywo steel, plastic сталь, пластмасса



Wózek dolny PRO rama
Bottom roller PRO frame
Нижний ролик PRO для рамной системы





		
A-WDR-PRO	50	stal, tworzywo steel, plastic сталь, пластмасса



Pozycjoner górny
Top positioner
Верхний стопор





		
A-PTG	50	tworzywo plastic пластмасса



Pozycjoner dolny PRO
Bottom positioner PRO
Нижний стопор PRO



		
A-PTD	50	stal steel сталь



Szczotka odbojowa 4,8x4
Buffer strip 4,8x4
Буферная щётка 4,8x4



		
A-SO-48X4	szary gray серый	tworzywo plastic пластмасса



Szczotka odbojowa szeroka 14,5x4
Buffer strip wide 14,5x4
Буферная щётка широкая 4,8x4



		
A-SO-145X4	szary / gray / серый	tworzywo plastic пластмасса
A-SO-145X4-10	biały / white / белый	
A-SO-145X4-20	czarny / black / чёрный	



Szczotka przeciwkurzowa bez kleju 4,8x7
 Anti-dust strip without glue 4,8x7
 Противопылевая щётка без клея 4,8x7



		
A-SP-48X7	szary gray серый	tworzywo plastic пластмасса



Szczotka przeciwkurzowa z klejem 7x12
 Anti-dust strip with glue 7x12
 Противопылевая щётка на клеевой основе 7x12



		
A-SP-7X12	szary gray серый	tworzywo plastic пластмасса



Szczotka przeciwkurzowa bez kleju 4,8x12
 Anti-dust strip without glue 4,8x12
 Противопылевая щётка 4,8x12 (вставная)



		
A-SP-48X12	szary gray серый	tworzywo plastic пластмасса



Klin do rączek
Wedge for handle
Клин для профиль-ручки



		
A-KR-4	biały white белый	tworzywo plastic пластмасса



Klin do listew poziomych
Wedge for horizontal strips
Клин для горизонтальных профилей



		
A-KLP-4	biały white белый	tworzywo plastic пластмасса



Klips do mocowania toru dolnego EVO 2
Mounting clip for bottom track EVO 2
Клипса для крепления нижней направляющей EVO 2







		
A-ZAT-TDEVO2	mleczny milk молочный	tworzywo plastic пластмасса



Uszczelka typ U, średnio twarda
Gasket U, medium hard
Уплотнитель тип U, средней твердости







			
A-USZCZ-U4	100	przeźroczysty transparent прозрачный	tworzywo plastic пластмасса



Uszczelka typ CH miękka
Seal type CH, soft
Уплотнитель типа CH, мягкий







			
A-USZCZ-CHM4	120	przeźroczysty transparent прозрачный	tworzywo plastic пластмасса



Uszczelka do toru dolnego EVO 2
Gasket for EVO 2 track
Уплотнитель для нижней направляющей EVO 2



			
A-USZCZ-TDEV02	200	mleczny milk молочный	PVC



Blachowkręć 6,3x40
Steel metal screw 6,3x40
Сборочный винт 6,3x40

	
A-B63-40	stal steel сталь





Blachowkręć 6,3x32
Steel metal screw 6,3x32
Сборочный винт 6,3x32

	
A-B63-32	stal steel сталь





Spowalnicz SIMON skrajny
Internal soft closing damper SIMON
Боковой доводчик SIMON

		
A-SOFT-30	30	stal, tworzywo steel, plastic сталь, пластмасса
A-SOFT-50	50	



Spowalnicz SIMON środkowy
Internal soft closing damper SIMON
Центральный доводчик SIMON





		
A-MSOFT-RAMA	50	stal, tworzywo steel, plastic сталь, пластмасса



Zestaw adpatera do spowalnicza środkowego
Adapter set for soft closing damper
Адаптер для доводчика



		
A-MSOFT-ADAPT	50	stal steel сталь



Ręczny przyrząd wiertarski z dociskiem
Hand drilling tool with locking screws
Ручной сверлильный кондуктор с зажимом



	
A-PW-RC-DOC	stal steel сталь



MITO
MITO
MITO

			 L mm	 kg ↓			
	Tor MITO Track MITO Направляющая MITO	A-TMITO-200-00	200	50	aluminium aluminium алюминий	aluminium aluminium алюминий	56
		A-TMITO-200-05					
		A-TMITO-250-00	250				
		A-TMITO-250-05					
		A-TMITO-300-00	300		surowe aluminium raw aluminum сырой алюминий		
		A-TMITO-300-05					
		A-TMITO-200-00*	200				
		A-TMITO-250-00*	250				
A-TMITO-300-00*	300						
	Pozycjoner Positioner Стопор	A-POZ-MITO	-		szary gray серый	tworzywo plastic пластмасса	1000
	Wózek górny Top guide Верхний проводник	A-SG-MITO	-		ocynk zink оцинковка	stal, tworzywo steel, plastic сталь, пластмасса	400
	Wózek dolny z łożyskiem kulkowym Bottom roller with ball bearing Нижний ролик с шариковым подшипником	A-RD-MITO	-				



* Dostępny na zamówienie / Available only for individual order / Доступен под заказ

Zestaw MITO PLUS
MITO PLUS set
MITO PLUS комплект



2 wózki górne ze sprężyną, 2 wózki dolne z łożyskiem kulkowym, 1 pozycjoner, komplet wkrętów
2 top rollers with spring, 2 bottom ball bearing rollers, 1 positioner, set of screws
2 верхних проводника с пружиной, 2 нижних ролика с шариковым подшипником, 1 стопор, комплект шурупов

	 kg ↓		
A-MITO-PLUS	50	ocynk / zink / оцинковка	stal / steel / сталь



Zestaw OVERLINE

OVERLINE set

OVERLINE комплект



2 szt. wózków zewnętrznych, 2 szt. wózków wewnętrznych, 2 szt. pozycjonerów, 2 szt. prowadników dolnych ślizgowych drzwi zewnętrznych, 2 szt. prowadników dolnych ślizgowych drzwi wewnętrznych
 2 external rollers, 2 internal rollers, 2 positioners, 2 bottom slides for external door, 2 bottom slides of internal door
 Внешние ролики-2шт., внутренние ролики-2шт., нижние ходовые элементы внешней двери-2 шт., нижние ходовые элементы внутренней двери-2 шт., позиционер-2 шт.

A-SN-FSET	50	ocynk / zink / оцинковка	stal, tworzywo / steel, plastic / сталь, пластмасса	10

	mm	kg				
	A-SN-R19RIV-270-05	2700	-	aluminium aluminium алюминий	aluminium aluminium алюминий	24
	A-SN-K19-270-05		-			48
	A-C18-300-S-05	3000	-			60
	A-SN-TG-405-00	4050	50	surowe aluminium raw aluminium сырой алюминий	stal steel сталь	80
	A-SN-TDS-405-00					40
	A-SN-SOFT-25	-	25	szary gray серый	tworzywo plastic пластмасса	100
	A-SN-SOFT-40	-	40			
	A-SN-ADSET	-	-	-	stal, tworzywo steel, plastic сталь, пластмасса	100



Zestaw OVERLINE PLUS
OVERLINE PLUS set
OVERLINE PLUS комплектация



2 szt. wózków zewnętrznych, 2 szt. wózków wewnętrznych, 2 szt. prowadników dolnych tocznych drzwi zewnętrznych, 2 szt. prowadników dolnych tocznych drzwi wewnętrznych, 1 zestaw wkretów

2 external rollers, 2 internal rollers, 2 bottom slides for external door, 2 bottom slides for internal door, screws

Составляющие: внешние ролики-2шт., внутренние ролики-2шт., нижние ходовые элементы внешней двери-2 шт., нижние ходовые элементы внутренней двери-2 шт., 1 клп. шурупов

							
A-SN-HSET1	50	ocynk / zink / оцинковка	stal, tworzywo / steel, plastic / сталь, пластмасса	1			
	Rączka RIVA Handle RIVA Ручка RIVA	A-SN-R19RIV-270-05	2700	-	aluminium aluminium алюминий	aluminium aluminium алюминий	24
	Profil C19 Handle C19 Ручка C19	A-SN-K19-270-05		-			48
	Profil C18 Handle C18 Ручка C18	A-C18-300-S-05		3000			-
	Tor górny Top track Верхняя направляющая	A-SN-TG-405-00	4050	-	surowe aluminium raw aluminium сырой алюминий	stal steel сталь	80
	Tor dolny Bottom track Нижняя направляющая	A-SN-TDT-405-00		-	aluminium aluminium алюминий	20	
	Spowalnicz Soft closing damper доводчик	A-SN-SOFT-25	-	25	-	tworzywo plastic пластмасса	100
		A-SN-SOFT-40	-	40	-		20
	Pozycjoner Positioner Стопор	A-SN-POZ	-	-	czarny black черный		20
	Zestaw do spowalnicza Soft closing damper set доводчик комплектация 1szt. aktywator drzwi zew. i 1 szt. wew., 4 szt. adapterów, 1 zestaw wkretów 1pc. activator outer door and 1 pc. inner door, 4 pcs. adapter, 1 screw set активатор внеш. двери-1 шт., активатор внутр. двери-1 шт., адаптер-4 шт., 1кпл. шурупов	A-SN-ADSET	-	-	-	stal, tworzywo steel, plastic сталь, пластмасса	100



Prostownica Warped door straightener Стяжка-выпрямитель



2 szt. listwy ściągającej, 2 szt. płytki naciągającej, 4 szt. płytki dociskowej, zaślepka, tuleja pozycjonująca, klucz do regulacji
Tightening strip 2 pcs, tensioning plate 2 pcs, pressure plate 4 pcs, cover cap, positioning sleeve, adjustment spanner
Планка с резьбой 2 шт., натяжная пластина 2 шт., прижимная пластина 4 шт., заглушка, зажимная гильза, ключ для регулировки



A-SN-SDP-TU

50

ocynk / zink / оцинковка

stal, tworzywo / steel, plastic / сталь, пластмасса



× 10



Zestaw QUANTUM

QUANTUM set

Комплект QUANTUM



2 szt. wózków, 2 szt. stoperów, 2 szt. przewodników, komplet wkrętów

Rollers 2 pcs, stoppers 2 pcs, guide 2pcs, screw set

Ролики - 2 шт., стопор - 2 шт., проводник - 2 шт., комплект шурупов

A-BUDP-SET	50	aluminium / aluminium / алюминий	stal, tworzywo / steel, plastic / сталь, пластмасса	24			
	Tor górný Top track Верхняя направляющая	A-TG-BUD-200-00	2000	50	surowe aluminium raw aluminium сырой алюминий	aluminium aluminium алюминий	15
		A-TG-BUD-300-00	3000				
	Uchwyt boczny Side holder Боковое крепление	A-BUD-UB	-		ocynk zink оцинковка	stal steel сталь	200
	Uchwyt górný Top holder Верхнее крепление	A-BUD-UG	-				
	Uchwyt maskownicy toru górnego Top track masking cover holder Держатель декоративной панели	A-BUD-UM	60		aluminium aluminium алюминий	aluminium aluminium алюминий	250
	Uchwyt do ramy (4 szt) Frame holder (4 pcs) Крепление плиты	A-BUD-UR	-		szary gray серый	stal, tworzywo steel, plastic сталь, пластмасса	100
	Uchwyt do płyty Board holder Держатель для плиты	A-BUD-UP	-	ocynk zink оцинковка	stal steel сталь		



Zestaw LOFT
LOFT set
Комплект LOFT

NEW

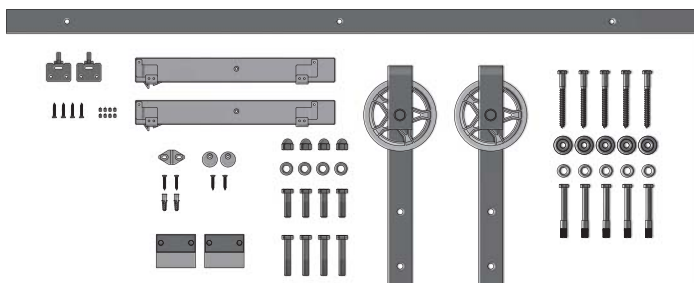

Wózki x2, prowadnik x1, tor 2m, tuleja dystansowa x5, odbojniki x2, zabezpieczenie przed wypadnięciem drzwi x2, spowalniacz x2, aktywator x2, komplet wkrętów i śrub

Roller 2 pcs, slide x1, Track 2m, distance sleeve x5, Bumper x2, stopper preventing door from falling out x2, Soft closing damper x2, activator x2, screw set

Ролик x2, проводник x1, Направляющая 2 м, Амортизатор x2, блокада x2, доводчик x2, активатор x2, кпл. шурупов

				
A-SN-LOFT-200-20M	100	czarny / black / чёрный	stal, tworzywo / steel, plastic / сталь, пластмасса	1



OŚWIETLENIE MEBLOWE FURNITURE LIGHTING МЕБЕЛЬНОЕ ОСВЕЩЕНИЕ

Taśmy LED LED strips Светодиодные ленты	470 – 472
Profile LED LED profiles Профили LED	473 – 494
Oprawy LED LED fittings Светодиодные светильники	494 – 513
Oprawy halogenowe Halogen fitting Галогенные светильники	514 – 515
Akcesoria Accessories Аксессуары	516 – 538
Przedłużacze biurkowe Desk power sockets Выдвижные удлинители	539 – 549















ТаЅма LED FLASH
LED strip FLASH
Светоодиодная лента FLASH



LD-3528-300-20-ZB	12 VDC 24 W	300 lm/m	● 6500 K	20	120°	5	8	60/m	5				
LD-3528-300-20-NE4P			● 4000 K										
LD-3528-300-20-CB			● 3200 K										
LD-3528-300-65-ZB		280 lm/m	● 6500 K	65									
LD-3528-300-65-CB			● 3200 K										
LD-3528-300-20-NI			-							niebieski/ blue / синий			
LD-3528-600-20-ZB	12 VDC 48 W	550 lm/m	● 6500 K	20			120°	5	8	120/m	2,5		
LD-3528-600-20-CB			● 3200 K										
LD-3528-600-65-ZB		520 lm/m	● 6500 K	65									
LD-3528-600-65-CB			● 3200 K										
LD-2835-300-20-ZB	12 VDC 30 W	750 lm/m	● 6500 K	20					120°	5	8	60/m	5
LD-2835-300-20-NE4P			● 4000 K										
LD-2835-300-20-CB			● 3200 K										
LD-2835-300-65-ZB		700 lm/m	● 6500 K	65									
LD-2835-300-65-CB			● 3200 K										
LD-2835-300-20-ZBN	12 VDC 33 W	850 lm/m	● 6500 K	20	120°	5	8	60/m			5		
LD-2835-300-20-NE4N			● 4000 K										
LD-2835-300-20-CBN			● 3200 K										
LD-2835-300-65-ZBN		730 lm/m	● 6500 K	65									
LD-2835-300-65-NE4N			● 4000 K										
LD-2835-300-65-CBN			● 3200 K										
LD-2835-600-20-ZB	12 VDC 60 W	1600 lm/m	● 6500 K	20			120°	5	10	120/m	2,5		
LD-2835-600-20-NE4			● 4000 K										
LD-2835-600-20-CB			● 3200 K										
LD-2835-600-65-ZB		1350 lm/m	● 6500 K	65									
LD-2835-600-65-CB			● 3200 K										



										
LD-2835-600-5MM-20-ZB	12 VDC 33 W	750 lm/m	 6500 K	20	120°	5	5	120/m	2,5	
LD-2835-600-5MM-20-NE4			 4000 K							
LD-2835-600-5MM-20-CB			 3200 K							
LD-2835-60-60-20-CCT	12 VDC 30 W	700 lm/m	 3200 K -  6500 K	65	120°	5	8	60/m	5	
LD-5050-300-20-ZB	12 VDC 72 W	900 lm/m	 6500 K							
LD-5050-300-20-CB			 3200 K							
LD-5050-300-65-ZB	12 VDC 80 W	850 lm/m	 6500 K	20	120°	5	10	60/m	5	
LD-5050-300-65-CB			 3200 K							
LD-5630-300-20-ZB	12 VDC 80 W	1750 lm/m	 6500 K	65	120°	5	10	60/m	5	
LD-5630-300-20-CB			 3200 K							
LD-5630-300-65-ZB		1700 lm/m	 6500 K							
LD-5630-300-65-CB			 3200 K							
LD-3014-1200-20-ZB	12 VDC 53 W	1300 lm/m	 6500 K	20	120°	5	10	240/m	1,25	
LD-3014-1200-20-NE4			 4000 K							
LD-3014-1200-20-CB			 3200 K							
LD-RGB-150-20	12 VDC 36 W	450 lm/m	 RGB	65	120°	5	10	30/m	10	
LD-RGB-150-65										

ТаЅма LED FLASH 50 m
LED FLASH strip 50 m
Светоодиодная лента LED FLASH



LD-2835-300-20-ZB-50	12 VDC 6 W/m	750 lm/m	● 6500 K	20	120°	50 m	8 mm	60/m	5
LD-2835-300-20-NE-50			● 5000 K						
LD-2835-300-20-CB-50			● 3200 K						
LD-3528-300-20-ZB-50	12 VDC 4,8 W/m	300 lm/m	● 6500 K	20	120°	50 m	8 mm	60/m	5
LD-3528-300-20-NE-50			● 5000 K						
LD-3528-300-20-NE4P-50			● 4000 K						
LD-3528-300-20-CB-50			● 3200 K						



ТаЅма LED BIS
LED strip BIS
Светоодиодная лента BIS



LD-3528B-300-20-ZB	12 VDC 24 W/m	300 lm/m	● 6500 K	20	120°	5	8	60/m	5	100
LD-3528B-300-20-CB			● 3200 K							
LD-3528B-300-65-ZB	12 VDC 24 W/m	280 lm/m	● 6500 K	65	120°	5	8	60/m	5	50
LD-3528B-300-65-CB			● 3200 K							



Profil GLAX nakładany, mikro
 GLAX profile surface mounted, micro
 Профиль GLAX накладной, микро



NEW

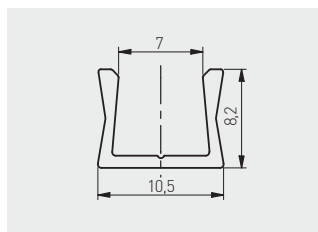
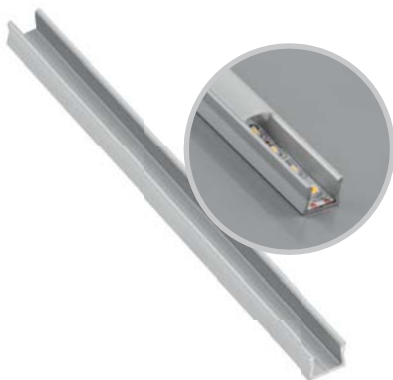

Wąska linia światła,
 Brak punktów świetlnych przy użyciu
 dedykowanej taśmy LED o szerokości 5 mm
 Narrow line of light.
 No visible points of light due to dedicated
 5mm LED strip
 Узкая линия света.
 Отсутствуют пункты свечения при
 использовании специальной ленты LED
 с шириной 5 мм.

				
PA-GLAXMICNK-AL	2	profil profile профиль	srebrny silver серебристый	aluminium aluminium алюминий
PA-GLAXMICNK3M-AL	3			
PA-OSMLGLAXMIC-00	2	ostonka mikro cover micro крышка микро	mleczna frosted молочная	tworzywo plastic пластик
PA-OSMLGLAXMIC3M-00	3			
PA-ZASGLAXMICNK-00	-	zaślepka end cap заглушка	szary gray серый	

Ostonki / Covers / Крышки:



PA-OSMLGLAXMIC-00

Zaślepki / End caps / Заглушки:



PA-ZASGLAXMICNK-00

Profil GLAX nakładany mini
GLAX profile mini surface mounted
Профиль GLAX накладной мини

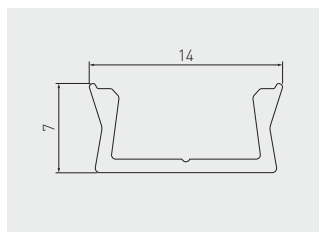
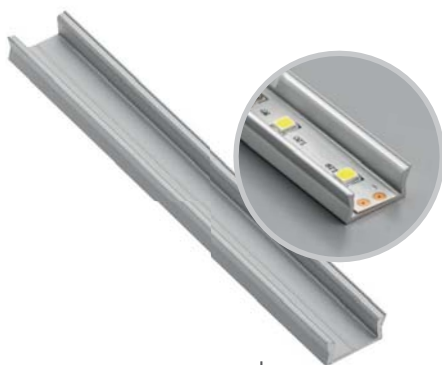

Taśma LED max 10 mm szerokości
LED strip width max 10 mm
Ширина светодиодной ленты не более 10 мм



PA-GLAXMNK-AL	2	profil profile профиль	srebrny / silver / серебристый	aluminium aluminium алюминий	
PA-GLAXMNK-AL-20M			czarny / black / черный		
PA-GLAXMNK-AL-10			biały / white / белый		
PA-GLAXMNK-AL-90			szampan / champagne / шампань		
PA-GLAXMNK3M-AL	3	ostonka mini cover mini крышка мини	srebrny / silver / серебристый		
PA-GLAXMNK3M-AL-20M			czarny / black / черный		
PA-GLAXMNK3M-AL-10			biały / white / белый		
PA-OSMLGLAXM-00	2	ostonka kwadratowa cover square крышка квадратная	mleczna / frosted / молочная		tworzywo plastic пластик
PA-OSMLGLAXM3M-00	3		ostonka okrągła cover round крышка круглая	transparentna / transparent прозрачная	
PA-OSTRGLAXM-00	2			mleczna / frosted / молочная	
PA-OSTRGLAXM3M-00	3	szary / gray / серый			
PA-OSMLGLAXMK-00	2	ostonka kwadratowa cover square крышка квадратная	biały / white / белый	ABS	
PA-OSMLGLAXMO-00			ostonka okrągła cover round крышка круглая		szampan / champagne / шампань
PA-ZASGLAXMNK-00	-	zaślepka standard end cap standard заглушка стандартная	czarny mat / black matt / чёрный матовый		
PA-ZASGLAXMNK-10			szary / gray / серый		
PA-ZASGLAXMNK-90			szary / gray / серый		
PA-ZASGLAXMNK-20M			szary / gray / серый		
PA-ZASGLAXMNNK-00	-	zaślepka kwadratowa end cap square заглушка квадратная	szary / gray / серый	ABS	
PA-ZASGLAXMNNKO-00	-	zaślepka okrągła end cap round заглушка круглая	szary / gray / серый		
PA-SPRGLAXM-00	-	uchwyt mounting clip держатель	srebrny / silver / серебристый		

Ostonki / Covers / Крышки:

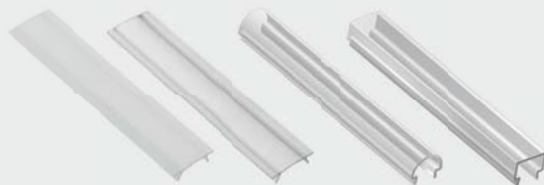

PA-OSMLGLAXM-00
PA-OSMLGLAXM3M-00

PA-OSTRGLAXM-00
PA-OSTRGLAXM3M-00

PA-OSMLGLAXMO-00

PA-OSMLGLAXMK-00

Zaślepki / End caps / Заглушки:



PA-ZASGLAXMNK-00

PA-ZASGLAXMNNK-00

Uchwyt / mounting
clip / держатель:





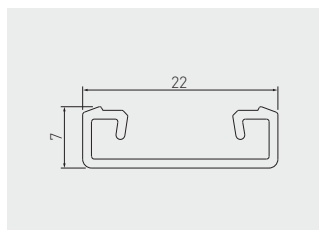

PA-ZASGLAXMNNKO-00

PA-SPRGLAXM-00

Profil GLAX nakładny
 GLAX profile surface mounted
 Профиль GLAX накладной



				
PA-GLAXNK-AL	2	profil profile профиль	srebrny silver серебристый	aluminium aluminium алюминий
PA-GLAXNK3M-AL	3			
PA-OSMLGLAXM-00	2	osłonka mini cover mini крышка мини	mleczna frosted молочная	tworzywo plastic пластик
PA-OSMLGLAXM3M-00	3		transparentna transparent прозрачная	
PA-OSTRGLAXM-00	2			
PA-OSTRGLAXM3M-00	3			
PA-ZASGLAXNK-00	-	zaślepka end cap заглушка	szary gray серый	

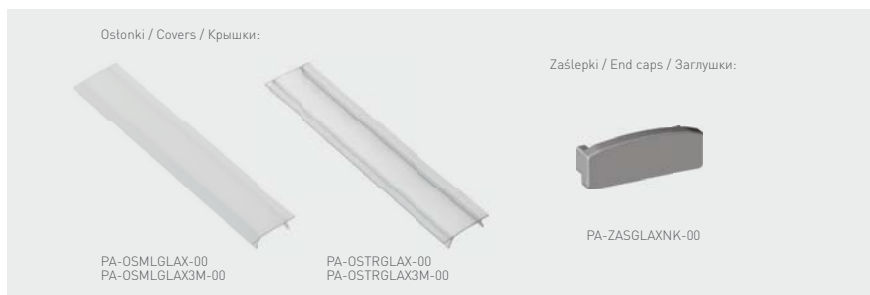

Profil GLAX nakładany mini, wysoki
 Profile GLAX surface mounted mini, high
 Профиль GLAX накладной мини, высокий

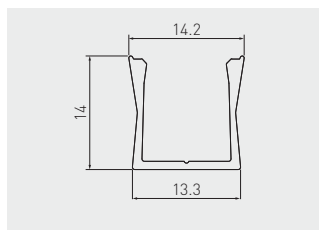

Brak widocznych punktów świetlnych
 Taśma LED max 10 mm szerokości
 No visible points of light
 LED strip width max 10 mm
 Нет видимых точек света
 Ширина светодиодной ленты не более 10 мм



PA-GLAXMNKW-AL	2	profil profile профиль	srebrny / silver / серебристый	aluminium aluminium алюминий
PA-GLAXMNKW-AL-20M			czarny / black / черный	
PA-GLAXMNKW-AL-10			biały / white / белый	
PA-GLAXMNKW-AL-90			szarpan / champagne / шампань	
PA-OSMLGLAXM-00	2	ostonka mini cover mini крышка мини	mleczna / frosted / молочная	tworzywo plastic пластик
PA-OSTRGLAXM-00			transparentna / transparent / прозрачная	
PA-ZASGLAXMNKW-00	-	zaślepka end cap заглушка	szary / gray / серый	ABS
PA-ZASGLAXMNKW-10			biały / white / белый	
PA-ZASGLAXMNKW-90			szarpan / champagne / шампань	
PA-ZASGLAXMNKW-20M			czarny mat / black matt / чёрный матовый	
PA-SPRGLAXM-00	-	uchwyt mounting clip держатель	srebrny / silver / серебристый	

Ostonki / Covers / Крышки:



PA-OSMLGLAXM-00

PA-OSTRGLAXM-00

Zaślepka / End cap / Заглушка:



PA-ZASGLAXMNKW-00

 Uchwyt / mounting clip /
держатель:

PA-SPRGLAXM-00

Profil GLAX wpuszczany, mikro
GLAX profile recessed, micro
Профиль GLAX врезной, микро



NEW

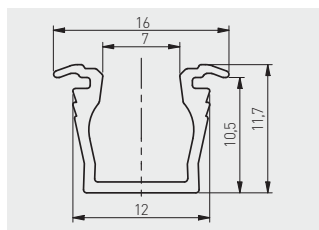
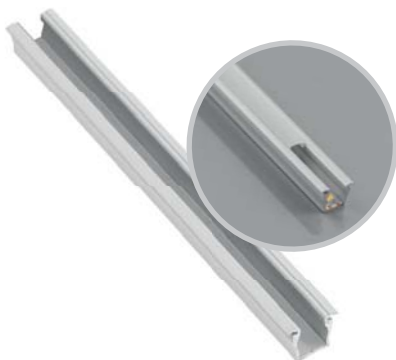

Wąska linia światła,
Brak punktów świetlnych przy użyciu
dedykowanej taśmy LED o szerokości 5 mm
Narrow line of light.
No visible points of light due to dedicated
5mm LED strip
Узкая линия света.
Отсутствуют пункты свечения при
использовании специальной ленты LED
с шириной 5 мм.

PA-GLAXMIC-AL	2	profil, profile, профиль	srebrny silver серебристый	aluminium aluminium алюминий
PA-GLAXMIC3M-AL	3			
PA-OSMLGLAXMIC-00	2	osłonka mikro cover micro крышка микро	mleczna frosted молочная	tworzywo plastic пластик
PA-OSMLGLAXMIC3M-00	3			
PA-ZASGLAXMIC-00	-	zaślepka end cap заглушка	szary gray серый	

Ostonki / Covers / Крышки:



PA-OSMLGLAXMIC-00

Zaślepki / End caps / Заглушки:



PA-ZASGLAXMIC-00

Profil GLAX wpuszczany
Profile GLAX recessed
Профиль LED GLAX врезной

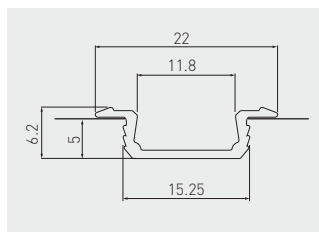

PA-GLAX-AL	2	profil profile профиль	srebrny / silver / серебристый	aluminium aluminium алюминий
PA-GLAX-AL-20M			czarny / black / черный	
PA-GLAX-AL-10			biały / white / белый	
PA-GLAX-AL-90			szarpan / champagne / шампань	
PA-GLAX3M-AL			srebrny / silver / серебристый	
PA-OSMLGLAX-00	2	osłonka cover крышка	mleczna frosted молочная	tworzywo plastic пластик
PA-OSMLGLAX3M-00	3		transparentna transparent прозрачная	
PA-OSTRGLAX-00	2			
PA-OSTRGLAX3M-00	3			
PA-ZASGLAX-00	-	zaślepka end cap заглушка	szary / gray / серый	ABS
PA-ZASGLAX-10			biały / white / белый	
PA-ZASGLAX-90			szarpan / champagne / шампань	
PA-ZASGLAX-20M			czarny mat / black matt / чёрный матовый	

Ostonki / Covers / Крышки:



PA-OSMLGLAXM-00

PA-OSTRGLAXM-00

Zaślepka / End cap / Заглушка:

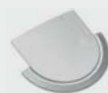

PA-ZASGLAX-00

Profil GLAX wpuszczany, wysoki
Profile GLAX recessed, high
Профиль LED GLAX врезной

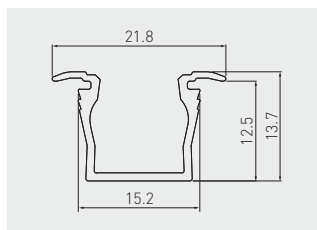

Brak widocznych punktów świetlnych
Taśma LED max 10 mm szerokości
No visible points of light
LED strip width max 10 mm
Нет видимых точек света
Ширина светодиодной ленты
не более 10 мм

PA-GLAXMW-AL	2	profil profile профиль	srebrny / silver / серебристый	aluminium aluminium алюминий	
PA-GLAXMW-AL-20M			czarny / black / черный		
PA-GLAXMW-AL-10			biały / white / белый		
PA-GLAXMW-AL-90			szarpan / champagne / шампань		
PA-OSMLGLAXM-00	2	ostonka mini cover mini крышка мини	mleczna frosted молочная	tworzywo plastic пластик	
PA-OSMLGLAXMK-00		ostonka kwadratowa cover square крышка квадратная			
PA-OSTRGLAXM-00		ostonka mini cover mini крышка мини	transparentna transparent прозрачная		
PA-ZASGLAXMW-00	-	zaślepka standard end cap standard заглушка стандартная	szary / gray / серый	ABS	
PA-ZASGLAXMW-10			biały / white / белый		
PA-ZASGLAXMW-90			szarpan / champagne / шампань		
PA-ZASGLAXMW-20M			czarny mat / black matt / чёрный матовый		
PA-ZASGLAXMWK-00	-	zaślepka kwadratowa end cap square заглушка квадратная	szary / gray / серый		

Ostonki / Covers / Крышки:

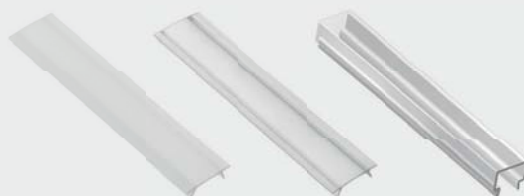

PA-OSMLGLAXM-00

PA-OSTRGLAXM-00

PA-OSMLGLAXMK-00

Zaślepki / End caps / Заглушки:





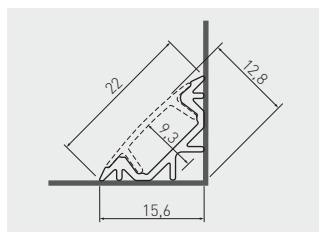

PA-ZASGLAXMW-00

PA-ZASGLAXMWK-00

Profil GLAX kątowy
GLAX corner profile
Профиль GLAX угловой



	 L m			
PA-GLAXKT-AL	2	profil profile профиль	srebrny silver серебристый	aluminium aluminium алюминий
PA-GLAXKT3M-AL	3			
PA-OSMLGLAX-00	2	ostonka cover крышка	mleczna frosted молочная	tworzywo plastic пластик
PA-OSMLGLAX3M-00	3		transparentna transparent прозрачная	
PA-OSTRGLAX-00	3			
PA-OSTRGLAX3M-00	2			
PA-ZASGLAXKT-00	-	zaślepka end cap заглушка	szary gray серый	ABS

Ostonki / Covers / Крышки:



PA-OSMLGLAX-00
PA-OSMLGLAX3M-00

PA-OSTRGLAX-00
PA-OSTRGLAX3M-00

Zaślepka / End cap / Заглушка:





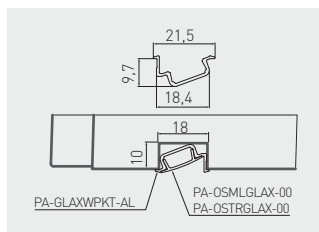

PA-ZASGLAXKT-00

Profil GLAX kątowy, wpuszczany
 Recessed corner profile GLAX
 Профиль GLAX угловой, врезной



Kąt świecenia 22°
 Beam angle 22°
 Угол свечения 22°

				
PA-GLAXWPKT-AL	2	profil profile профиль	srebrny silver серебристый	aluminium aluminium алюминий
PA-OSMLGLAX-00		ostonka cover крышка	mleczna frosted молочная	tworzywo plastic пластик
PA-OSTRGLAX-00			transparentna transparent прозрачная	

Ostonki / Covers / Крышки:



PA-OSMLGLAX-00



PA-OSTRGLAX-00

Profil GLAX kątowy, nakładany
 GLAX aluminium corner profile – surface mounted
 Профиль LED GLAX угловой, накладной

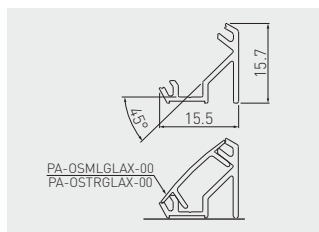

PA-GLAXNKKT-AL	2	profil profile профиль	srebrny / silver / серебристый	aluminium aluminium алюминий	
PA-GLAXNKKT-AL-20M			czarny / black / черный		
PA-GLAXNKKT-AL-10			biały / white / белый		
PA-GLAXNKKT-AL-90			szampan / champagne / шампань		
PA-GLAXNKKT3M-AL	3		srebrny / silver / серебристый		
PA-OSMLGLAX-00	2	osłonka cover крышка	mleczna frosted молочная	tworzywo plastic пластик	
PA-OSMLGLAX3M-00	3		transparentna transparent прозрачная		
PA-OSTRGLAX-00	2				
PA-OSTRGLAX3M-00	3				
PA-OSMLGLAXT-00	2	osłonka trójkątna cover triangular крышка треугольная	mleczna frosted молочная		
PA-ZASGLAXNKKT-00	-	zaślepka standard end cap standard заглушка стандартная	szary / gray / серый	ABS	
PA-ZASGLAXNKKT-10			biały / white / белый		
PA-ZASGLAXNKKT-90			szampan / champagne / шампань		
PA-ZASGLAXNKKT-20M			czarny mat / black matt / чёрный матовый		
PA-ZASGLAXNKKT-00		zaślepka trójkątna end cap triangular заглушка треугольная	szary / gray / серый		

Osłonki / Covers / Крышки:

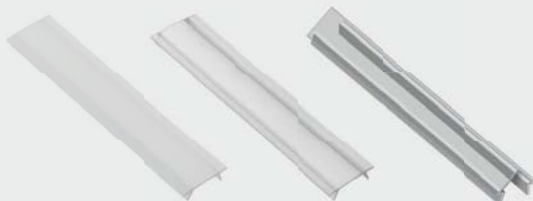
 PA-OSMLGLAX-00
 PA-OSMLGLAX3M-00

 PA-OSTRGLAX-00
 PA-OSTRGLAX3M-00

PA-OSMLGLAXT-00

Zaślepki / End caps / Заглушки:



PA-ZASGLAXNKKT-00

PA-ZASGLAXNKKT-00

Profil GLAX z radiatorem
Profile GLAX with heatsink
Профиль GLAX с радиатором



NEW

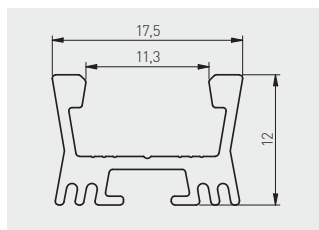

Dedykowana soczewka zawężająca kąt świecenia do 60°.

Możliwość zawieszenia oprawy za pomocą linek
Dedicated lens that narrow the beam angle to 60 degrees

Possibility to suspend the fixture using lines
Специальная линза, сужающая угол свечения до 60 градусов
Возможность монтажа с помощью крепления-тросика

				
PA-GLAXRAD-AL	2	profil, profile, профиль	srebrny silver серебристый	aluminium aluminium алюминий
PA-OSMLGLAXSO-00	2	osłonka soczewka, cover lenticular, крышка линзовидный	transparentna transparent прозрачная	tworzywo plastic пластик
PA-OSMLGLAX-00	2	osłonka cover крышка	mleczna frosted молочная	
PA-OSTRGLAX-00		transparentna transparent прозрачная		
PA-ZASGLAXRAD-00	-	zaślepka end cap заглушка	szary / gray / серый	ABS
PA-ZAWGLAXDR-00	1,5	zawieszka hanger подвес для профиля	chrom chrome хром	stal steel сталь
PA-SPRGLAXM-00	-	uchwyt mounting clip держатель	srebrny / silver / серебристый	ABS

Ostonki / Covers / Крышки:



PA-OSMLGLAXSO-00

PA-OSMLGLAX-00

PA-OSTRGLAX-00

Uchwyt / mounting clip /
держатель:



PA-SPRGLAXM-00

Zawieszka / Hanger
Подвес для профиля



PA-ZAWGLAXDR-00

Profil GLAX z regulowanym kątem
 Profile GLAX with adjustable angle
 Профиль GLAX с регулировкой угла

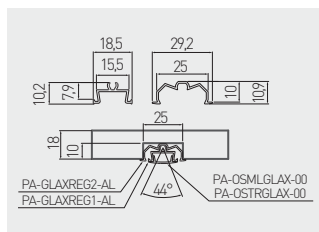

PA-GLAXREG1-AL	2	profil profile профиль	srebrny silver серебристый	aluminium aluminium алюминий
PA-GLAXREG2-AL				
PA-OSMLGLAX-00	2	ostonka cover крышка	mleczna frosted молочная	tworzywo plastic пластик
PA-OSTRGLAX-00			transparentna transparent прозрачная	

Ostonki / Covers / Крышки:



PA-OSMLGLAX-00



PA-OSTRGLAX-00

Profil GLAX wieńcowy
Rim profile GLAX
Профиль GLAX, торцевой

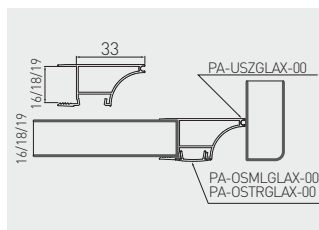

PA-GLAXWN-AL	18	2	profil profile профиль	srebrny silver серебристый	aluminium aluminium алюминий
PA-GLAXWN16-AL	16				
PA-GLAXWN19-AL	19				
PA-OSMLGLAX-00	-	2	ostonka cover крышка	mleczna frosted молочная	tworzywo plastic пластик
PA-OSTRGLAX-00				transparentna transparent прозрачная	
PA-USZGLAX-00N	-	10	uszczelka cord gasket уплотнитель	czarny black чёрный	EPDM

Ostonki / Covers / Крышки:



PA-OSMLGLAX-00



PA-OSTRGLAX-00

Uszczelka / Cord gasket / Уплотнитель



PA-USZGLAX-00N

Profil GLAX półkowy mini
Shelf profile GLAX mini
Профиль GLAX полочный мини

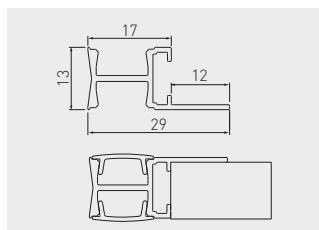

Możliwość zastosowania 3 taśm LED
Possibility of using 3 LED strips
Возможность использования
3 светодиодных лент

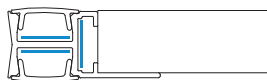

PA-GLAXMPK-AL	2	profil profile профиль	srebrny silver серебристый	aluminium aluminium алюминий
PA-OSMLGLAXM-00		osłonka mini cover mini крышка мини	mleczna frosted молочная	tworzywo plastic пластик
PA-OSTRGLAXM-00			transparentna transparent прозрачная	

Ostonki / Covers / Крышки:



PA-OSMLGLAXM-00



PA-OSTRGLAXM-00

Profil GLAX drążkowy
GLAX rail profile
Профиль-штанга GLAX

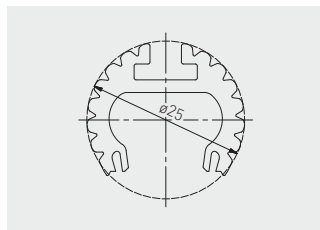

Możliwości montażu jako:

Assembly options as:

Варианты сборки:

- drążek w szafie
- rod in the closet
- sterzeń w шкафу
- oprawa zwieszana
- suspended luminaire
- подвесной светильник

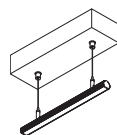
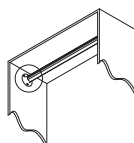

PA-GLAXDR-AL		profil profile профиль	srebrny silver серебристый	aluminium aluminium алюминий
PA-OSMLGLAX-00	2	ostonka cover крышка	mleczna frosted молочная	tworzywo plastic пластик
PA-OSTRGLAX-00			transparentna transparent прозрачная	
PA-ZASGLAXDR-00	-	zaślepka end cap заглушка	szary gray серый	ZnAl
PA-ROZGLAX-53	-	rozetka rail socket монтажный крепеж		
PA-ZAWGLAXDR-00	1,5	zawieszka hanger подвес для профиля	chrom chrome хром	stal steel сталь

Ostonki / Covers / Крышки:



PA-OSMLGLAX-00

PA-OSTRGLAX-00

Zaślepka / End cap
Заглушка



PA-ZASGLAXDR-00

Rozetka / Rail socket
Монтажный крепеж



PA-ROZGLAX-53







Zawieszka / Hanger
Подвес для профиля

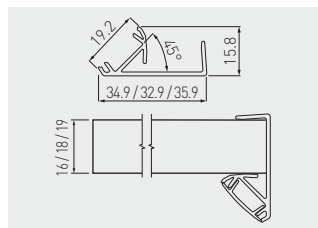

PA-ZAWGLAXDR-00

Profil GLAX kątowy, nabijany, jednostronny
 GLAX aluminium edge profile – single-sided
 Профиль LED GLAX торцевой, односторонний



		 BOARD mm	 L m			
PA-GLAXNBJ2M16-AL		16	2	profil profile профиль	srebrny silver серебристый	aluminium aluminium алюминий
PA-GLAXNBJ3M16-AL		16	3			
PA-GLAXNBJ3M-AL		18	3			
PA-GLAXNBJ2M19-AL		19	2			
PA-GLAXNBJ3M19-AL		19	3			
PA-OSMLGLAX-00		-	2	ostonka cover крышка	mleczna frosted молочная	tworzywo plastic пластик
PA-OSMLGLAX3M-00		-	3		transparentna transparent прозрачная	
PA-OSTRGLAX-00		-	2			
PA-OSTRGLAX3M-00		-	3			

Ostonki / Covers / Крышки:



PA-OSMLGLAX-00
 PA-OSMLGLAX3M-00



PA-OSTRGLAX-00
 PA-OSTRGLAX3M-00

Profil GLAX, kątowy, nabijany, jednostronny (do wypełnienia obrzeżem)
 GLAX aluminium edge profile – single-sided (option to fill with matching edge banding)
 Профиль LED GLAX торцевой, кромочный, односторонний

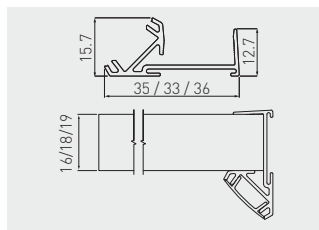

PA-GLAXNBW2M16-AL	16	2	profil profite профиль	srebrny silver серебристый	aluminium aluminium алюминий
PA-GLAXNBW3M16-AL	16	3			
PA-GLAXNBW3M-AL	18	3			
PA-GLAXNBW2M19-AL	19	2			
PA-GLAXNBW3M19-AL	19	3			
PA-OSMLGLAX-00	-	2	osłonka cover крышка	mleczna frosted молочная	tworzywo plastic пластик
PA-OSMLGLAX3M-00	-	3		transparentna transparent прозрачная	
PA-OSTRGLAX-00	-	2			
PA-OSTRGLAX3M-00	-	3			

Ostonki / Covers / Крышки:



PA-OSMLGLAX-00
PA-OSMLGLAX3M-00



PA-OSTRGLAX-00
PA-OSTRGLAX3M-00

Profil GLAX kątowy, nabijany, dwustronny
 GLAX aluminium edge profile – double sided
 Профиль LED GLAX торцевой, двухсторонний

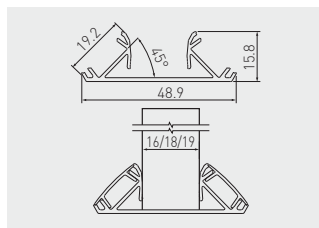

	BOARD mm	L m			
PA-GLAXNBD2M16-AL	16	2	profil profile профиль	srebrny silver серебристый	aluminium aluminium алюминий
PA-GLAXNBD3M16-AL	16	3			
PA-GLAXNBD3M-AL	18	3			
PA-GLAXNBD2M19-AL	19	2			
PA-GLAXNBD3M19-AL	19	3			
PA-OSMLGLAX-00	-	2	ostonka cover крышка	mleczna frosted молочная	tworzywo plastic пластик
PA-OSMLGLAX3M-00	-	3		transparentna transparent прозрачная	
PA-OSTRGLAX-00	-	2			
PA-OSTRGLAX3M-00	-	3			

Ostonki / Covers / Крышки:



PA-OSMLGLAX-00
 PA-OSMLGLAX3M-00



PA-OSTRGLAX-00
 PA-OSTRGLAX3M-00

Profil GLAX kątowy, nabijany, dwustronny (do wypełnienia obrzeżem)
 GLAX aluminium edge profile – double sided (option to fill with matching edge banding)
 Профиль LED GLAX торцевой, кромочный, двухсторонний

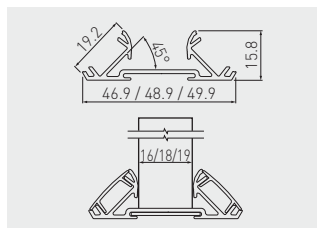

PA-GLAXNBDW2M16-AL	16	2	profil profile профиль	srebrny silver серебристый	aluminium aluminium алюминий
PA-GLAXNBDW3M16-AL	16	3			
PA-GLAXNBDW3M-AL	18	3			
PA-GLAXNBDW2M19-AL	19	2			
PA-GLAXNBDW3M19-AL	19	3			
PA-OSMLGLAX3M-00	-	3	ostonka cover крышка	mleczna frosted молочная	tworzywo plastic пластик
PA-OSTRGLAX3M-00	-		transparentna transparent прозрачная		

Ostonki / Covers / Крышки:



PA-OSMLGLAX3M-00



PA-OSTRGLAX3M-00

Profil GLAX kątowy, nabijany, wąski, jednostronny
 Corner profile GLAX, one-sided, edge mounted
 Профиль GLAX угловой, накладной, узкий, односторонний

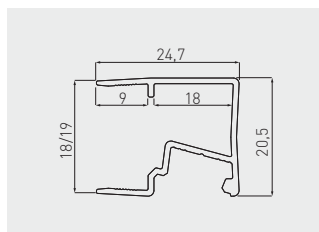

PA-GLAXMNBW3M-AL	18	3	profil profile профиль	srebrny silver серебристый	aluminium aluminium алюминий	
PA-GLAXMNBW3M19-AL	19					
PA-OSMLGLAXM3M-00	-		ostonka mini cover mini крышка мини	mleczna frosted молочная	tworzywo plastic пластик	
PA-OSTRGLAXM3M-00	-			transparentna transparent прозрачная		

Ostonki / Covers / Крышки:



PA-OSMLGLAXM3M-00



PA-OSTRGLAXM3M-00

Profil GLAX kątowy, nabijany, wąski, dwustronny
 Corner profile GLAX, narrow, two-sided
 Профиль GLAX угловой, накладной, узкий двусторонний

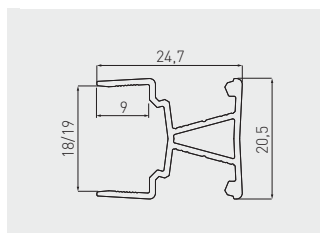

PA-GLAXMNBW3M-AL	18	3	profil profile профиль	srebrny silver серебристый	aluminium aluminium алюминий		
PA-GLAXMNBW3M19-AL	19						
PA-OSMLGLAXM3M-00	-				ostonka mini cover mini крышка мини	mleczna frosted молочная	tworzywo plastic пластик
PA-OSTRGLAXM3M-00	-					transparentna transparent прозрачная	

Ostonki / Covers / Крышки:



PA-OSMLGLAXM3M-00



PA-OSTRGLAXM3M-00

Profil GLAX wpuszczany z poliwęglanu
 Recessed polycarbonate profile GLAX
 Профиль GLAX врезной из поликарбоната

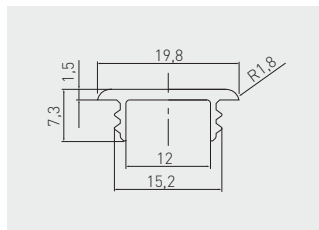

PW-PC31209-00N	2	mleczna / frosted / молочная	tworzywo plastic / пластик
PW-PC61209-00		transparentna / transparent / прозрачная	

Oprawa VASCO nakładana / wpuszczana
 Fixture Vasco surface mounted / recessed
 Светильник Vasco накладной / врезной

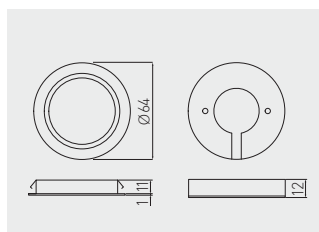

LD-VA24CB-10	130 mm	3000 K	biały połysk / white gloss / белый глянец	tworzywo plastic / пластик	
LD-VA24NE-10		4000 K			
LD-VA24ZB-10		6000 K			
LD-VA24CB-20		3000 K	czarny połysk / black gloss / чёрный глянец		
LD-VA24NE-20		4000 K			
LD-VA24ZB-20		6000 K			
LD-VA24CB-53		3000 K	aluminium / aluminium / алюминий		
LD-VA24NE-53		4000 K			
LD-VA24ZB-53		6000 K			



Оправа LUMINO
 Fixture LUMINO
 Светильник LUMINO

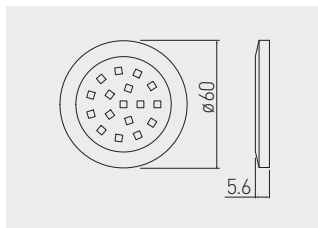

LD-LU16CB-10	70-85 lm	● 2700 K	biały połysk white gloss белый глянец	tworzywo plastic пластик
LD-LU16NE-10		● 4000 K		
LD-LU16ZB-10		● 6500 K		
LD-LU16CB-20		● 2700 K	czarny połysk black gloss чёрный глянец	
LD-LU16NE-20		● 4000 K		
LD-LU16ZB-20		● 6500 K		
LD-LU16CB-53		● 2700 K	aluminium aluminium алюминий	
LD-LU16NE-53		● 4000 K		
LD-LU16ZB-53		● 6500 K		



Оправа Jovita
 Fixture Jovita
 Светильник Jovita

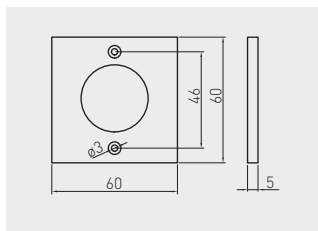

LD-KJVCOB-CB	200 lm	● 3000 K	aluminium aluminium алюминий	aluminium aluminium алюминий
LD-KJVCOB-ZB		● 6400 K		



Оправа Jovita
 Fixture Jovita
 Светильник Jovita

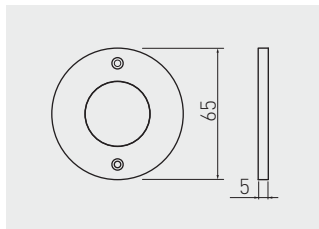

LD-OJVCOB-CB	200 lm	3000 K	aluminium aluminium алюминий	aluminium aluminium алюминий
LD-OJVCOB-ZB		6400 K		



Оправа Jovita
 Fixture Jovita
 Светильник Jovita

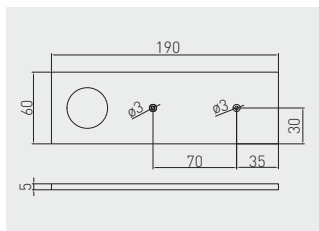

LD-PJVCOB-CB	200 lm	3000 K	aluminium aluminium алюминий	aluminium aluminium алюминий
LD-PJVCOB-ZB		6400 K		



Оправа LUGO
 Fixture LUGO
 Светильник LUGO

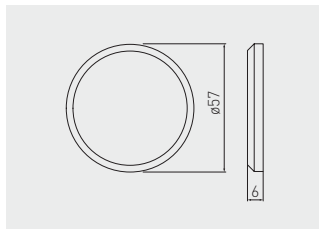

LD-LCG119-53	110 lm	● 3000 K	aluminium	tworzywo plastic
LD-LUG119-53		● 6400 K	aluminium	
LD-LCG119-40		● 3000 K	chrom	
LD-LUG119-40		● 6400 K	chrome	
LD-LCG119-52		● 3000 K	satyna	
LD-LUG119-52		● 6400 K	satin	



Оправа CASTELLO z włącznikiem
 Fixture CASTELLO with switch
 Светильник CASTELLO с выключателем

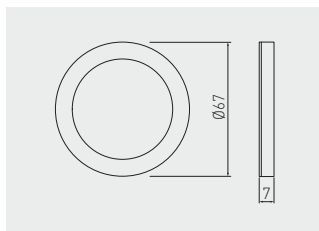

LD-CS36CB-53	180 lm	● 3200 K	aluminium	tworzywo plastic	
LD-CS36NE-53		● 4000 K			aluminium
LD-CS36ZB-53		● 6200 K			aluminium



Оправа ESTELLA Fixture ESTELLA Светильник ESTELLA

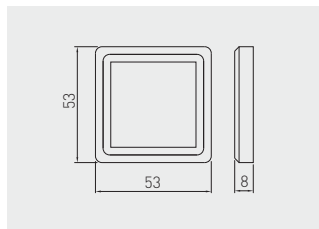

Model	Beam Angle	Color Temperature	Material	Material
LD-ES21CB-53N	110 lm	3000 K	aluminium aluminium алюминий	tworzywo plastic пластик
LD-ES21NE-53N		4000 K		
LD-ES21ZB-53N		6400 K		



Оправа VEGAS Fixture VEGAS Светильник VEGAS

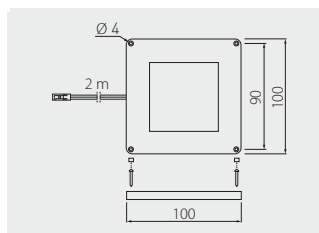

Model	Beam Angle	Color Temperature	Material	Material
LD-VE15CB-53	140 lm	3000 K	aluminium aluminium алюминий	tworzywo / aluminium plastic / aluminium пластмасса / алюминий
LD-VE15NE-53	145 lm	4000 K		
LD-VE15ZB-53	150 lm	6400 K		



Оправа VEGAS 2 w 1
 Fixture VEGAS 2 in 1
 Светильник VEGAS 2 в 1

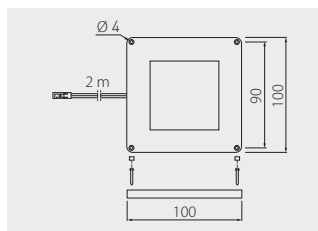

Powiązane produkty:
 Włącznik, regulator światła
 AE-WLKON-20
 Related products:
 Switch, colour temperature controller
 AE-WLKON-20



Связанных с ними продуктов:
 Выключатель, регулятор цветовой температуры
 AE-WLKON-20



LD-VE15CBZB-53	140 lm	● 3000 K - ● 6400 K	aluminium aluminium алюминий	tworzywo / aluminium plastic / aluminium пластмасса / алюминий
----------------	--------	---------------------	------------------------------------	--



Оправа ALVARO wpuszczana
 Recessed fixture ALVARO
 Врезной светильник ALVARO

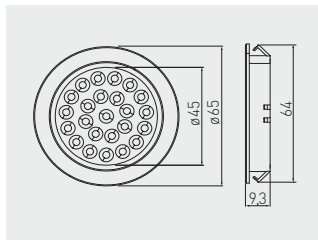

LD-AL24CB-53	130 lm	3000 K	aluminium aluminium алюминий	tworzywo plastic пластик					
LD-AL24NE-53		4000 K							
LD-AL24ZB-53		6400 K							

Оправа TREVI
 Fixture TREVI
 Светильник TREVI

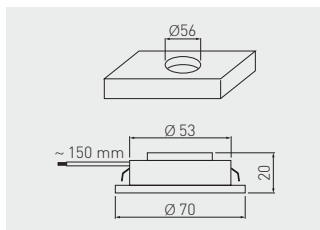

LD-TR24CB-53	300 lm	3000 K	aluminium aluminium алюминий	tworzywo plastic пластик				
LD-TR24ZB-53		6400 K						

Oprawa trójkątna z włącznikiem
Triangle fixture with switch
Треугольный светильник с выключателем

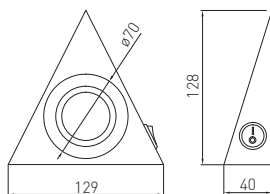

LD-OPT30S-53N	100 lm	● 3000 K	aluminium / aluminium / алюминий	stal steel сталь
LD-OPT60S-53N		● 6400 K		
LD-OPT30S-51N		● 3000 K	stal szcztokowana / brushed steel / шлифованная сталь	
LD-OPT60S-51N		● 6400 K		
LD-OPT60S-52N		● 6400 K		



Zestaw opraw trójkątnych z włącznikiem
Triangle fixture kit with switch
Комплект треугольных светильников с выключателем

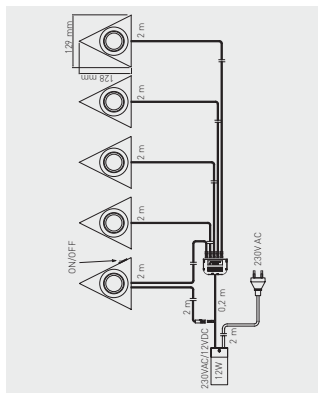

LD-Z50TCB-51	5 x 100 lm	● 3000 K	stal szcztokowana brushed steel шлифованная сталь	stal, tworzywo steel, plastic сталь, пластмасса



Zestaw opraw CASTELLO z włącznikiem
 Fixture kit with switch CASTELLO
 Комплект светильников CASTELLO с выключателем

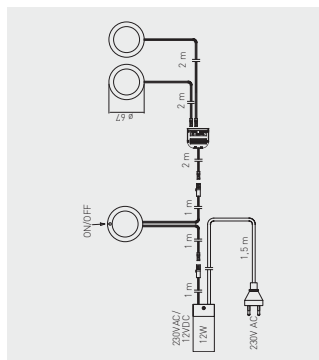

LD-Z3CSCB-53	3 x180 lm	● 3000 K	aluminium / aluminium / алюминий	tworzywo / plastic / пластик



Zestaw opraw CASTELLO z włącznikiem
 Fixture kit CASTELLO with switch
 Комплект светильников CASTELLO с выключателем

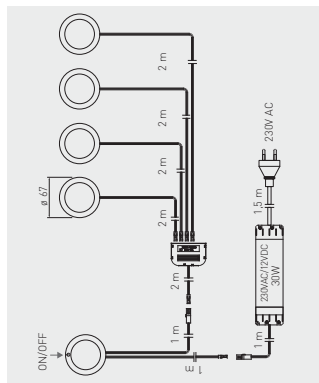

LD-Z5CSCB-53	5x180 lm	● 3000 K	aluminium / aluminium / алюминий	tworzywo / plastic / пластик



Zestaw opraw LUGO
 Fixture kit LUGO
 Комплект светильников LUGO

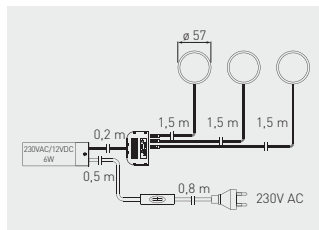

LD-LCG319-53	3x110 lm	● 3000 K	aluminium / aluminium / алюминий	tworzywo plastic пластик	10
LD-LUG319-53		● 6400 K			20
LD-LCG319-40		● 3000 K	chrom / chrome / хром		16
LD-LUG319-40		● 6400 K			20
LD-LCG319-52		● 3000 K	satyna / satin / сатин		20
LD-LUG319-52		● 6400 K			20



Zestaw opraw BARRI
 Fixture kit BARRI
 Комплект светильников BARRI

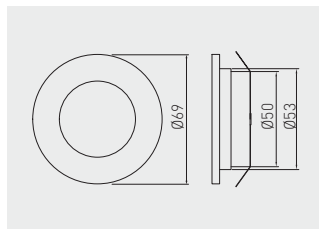

LD-OBP27CB-53	3x80 lm	● 2700 K	aluminium	aluminium, tworzywo aluminium, plastic алюминий, пластмасса	
LD-OBP27ZB-53		● 6400 K	aluminium алюминий		



Zestaw opraw MARBELLA
 Fixture kit MARBELLA
 Комплект светильников MARBELLA

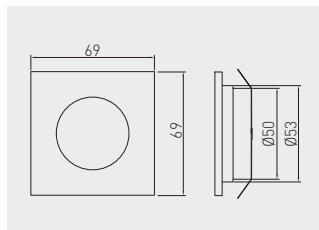

LD-KWP27CB-53	3x80 lm	2700 K	aluminium	aluminium, tworzywo
LD-KWP27ZB-53		6400 K	aluminium	aluminium, plastic
		алюминий	алюминий	алюминий, пластмасса



Oprawa OVIEDO wpuszczana
 Recessed fixture OVIEDO
 Врезной светильник OVIEDO

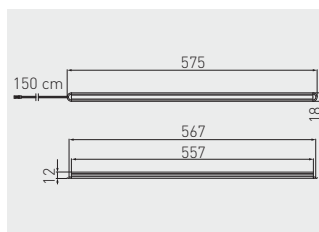

LD-WL2457-53	90 lm	6400 K	aluminium	aluminium, tworzywo
			aluminium	aluminium, plastic
			алюминий	алюминий, пластмасса



Оправа FRAGA podszafkowa z włącznikiem
 Cabinet fixture with switch FRAGA
 Светильник под шкафчики FRAGA с выключателем

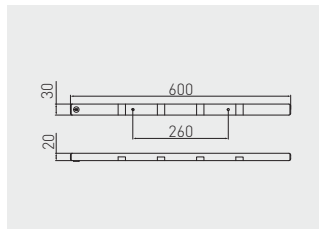

LD-OP408C-53	3 W	90 lm	6400 K	aluminium aluminium алюминий	aluminium, tworzywo aluminium, plastic алюминий, пластмасса



Оправа ROTA podszafkowa
 Cabinet ROTA fixture
 Светильник ROTA под шкафчики

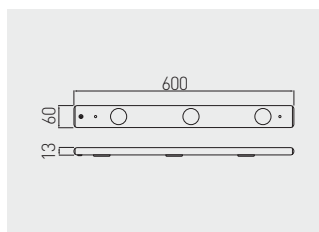

LD-OP456C-53	4,2 W	230 lm	6400 K	aluminium aluminium алюминий	aluminium, tworzywo aluminium, plastic алюминий, пластмасса
LD-OP609C-53	5,5 W	310 lm			



Оправа OPD podszafkowa
Under cabinet LED lamp fixture OPD
Светодиодный светильник OPD под шкафчик

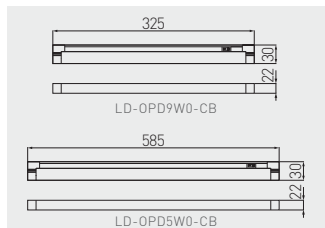

LD-OPD5W0-CB	5 W	300 lm	● 3000 K	chrom chrom хром	metal metal металл
LD-OPD9W0-CB	9 W	350 lm			



Оправа SORIA z czujnikiem zbliżeniowym
Fixture with proximity sensor SORIA
Светильник с датчиком приближения SORIA

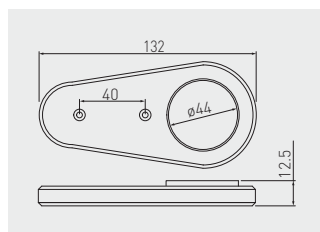

LD-SR16CB-53	90-110 lm	● 3000 K	aluminium aluminium алюминий	aluminium aluminium алюминий
LD-SR16NE-53		● 4000 K		
LD-SR16ZB-53		● 6400 K		



Оправа FOCUS na wysięgniku
 Fixture with arm FOCUS
 Светильник типа „дуга” FOCUS

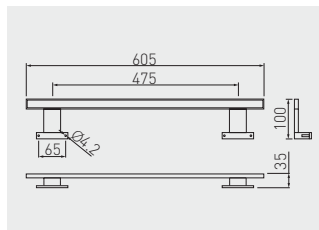

LD-F0120CB-40	740 lm	● 3000 K	chrom chrome хром	aluminium, tworzywo aluminium, plastic алюминий, пластмасса
LD-F0120ZB-40		● 6400 K		



Оправа RADIUS II na wysięgniku
 Fixture with arm RADIUS II
 Светильник типа „дуга” RADIUS II

NEW

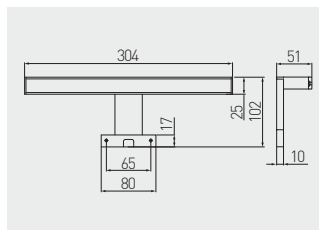

LD-RA60CB-40N	220 lm	● 3000 K	chrom chrome хром	tworzywo plastic пластмасса
LD-RA60ZB-40N		● 6400 K		



Оправа MAXIMUS на wysięgniku
 Fixture with arm MAXIMUS
 Светильник типа „дуга” MAXIMUS

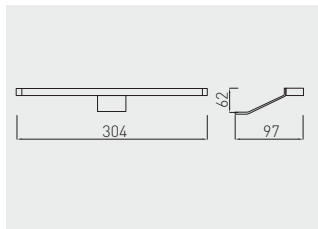

LD-MAX60CB-40N	160 lm	3000 K	chrom chrome хром	aluminium, tworzywo aluminium, plastic алюминий, пластмасса
LD-MAX60ZB-40N		6400 K		



Оправа COSTA на wysięgniku
 Fixture with arm COSTA
 Светильник типа „дуга” COSTA

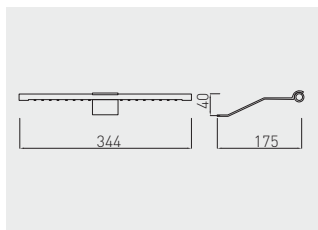

LD-CO20CB-53	100 lm	3000 K	aluminium aluminium алюминий	aluminium, tworzywo aluminium, plastic алюминий, пластмасса
LD-CO20ZB-53		6400 K		



Оправа ABELLA na wysięgniku
 Fixture with arm ABELLA
 Светильник типа „дуга” ABELLA

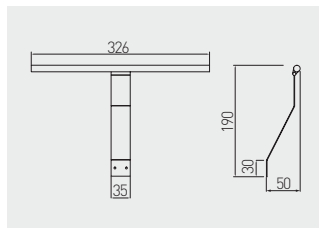

LD-AB18CB-53	460 lm	● 3000 K	aluminium aluminium алюминий	stal, aluminium, tworzywo steel, aluminium, plastic сталь, алюминий, пластмасса
LD-AB18ZB-53		● 6400 K		



Оправа EVITA na wysięgniku
 Fixture with arm EVITA
 Светильник типа „дуга” EVITA

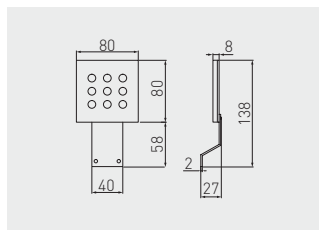

LD-EIW09CB-CZ	120 lm	● 3000 K	czarny / black / чёрный	aluminium, tworzywo aluminium, plastic алюминий, пластмасса



Оправа NOELIA na wysięgniku
 Fixture with arm NOELIA
 Светильник типа „дуга” NOELIA

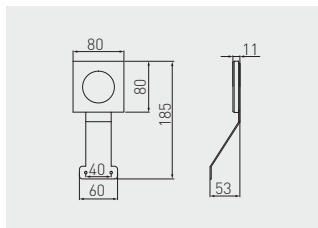

LD-NO24CB-00	330 lm	3000 K	aluminium aluminium алюминий	aluminium, tworzywo aluminium, plastic алюминий, пластмасса
LD-NO24ZB-00		6400 K		



Оправа FIDELIA na wysięgniku
 Fixture with arm FIDELIA
 Светильник типа „дуга” FIDELIA

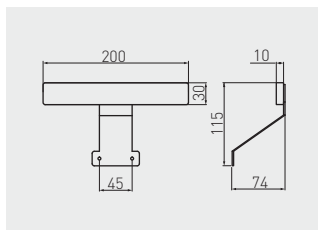

LD-FL36CB-00	155 lm	3000 K	aluminium aluminium алюминий	aluminium, tworzywo aluminium, plastic алюминий, пластмасса
LD-FL36ZB-00	165 lm	6400 K		



Oprawa CALDERON na wysięgniku
 Fixture with arm CALDERON
 Светильник типа „дуга” CALDERON

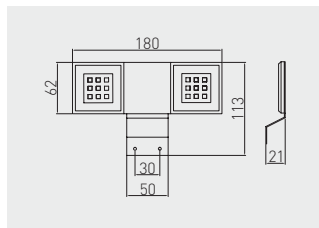

LD-NKW18CB-40	270lm	3000 K	chrom	stal, tworzywo steel, plastic сталь, пластмасса
LD-NKW18ZB-40		6400 K	chrome хром	



Oprawa COMA bezprzewodowa
 Wireless fixture COMA
 Беспроводной светильник COMA



LD-IRUSB-53

LD-PIRUSB-53

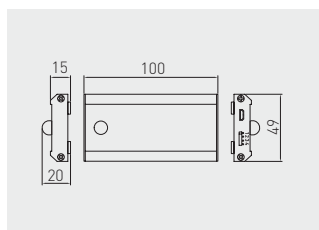

Dodatkowy przewód USB [do ładowania] - 0,5 m w komplecie
 Additional 0,5m USB cable (for charging)
 Дополнительный кабель USB (для зарядки) - 0,5 m

LD-IRUSB-53	40-50 lm	4000 K	Czujnik zbliżeniowy IR, jedno- lub dwu-biegowy Proximity sensor IR, single or double-pole Датчик движения IR, одно- и многофункциональный	aluminium aluminium алюминий	metal, tworzywo metal, plastic металл, пластик
LD-PIRUSB-53			Czujnik ruchu PIR, jednobiegowy Proximity sensor IR, single-pole Датчик движения PIR, однофункциональный		



Lampka CHICAGO z portem USB Bed lamp with USB CHICAGO Гибкая лампа с USB-разъемом CHICAGO

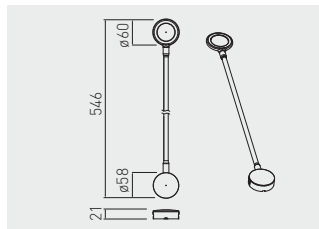

Wymaga zasilacza 12 V, 30 W
Requires 12 V, 30 W power supply
Требуется блок питания 12 В, 30 Вт

LD-CHIC16NE-10	120 lm	● 4000 K	biały / white / белый	stal, tworzywo steel, plastic сталь, пластмасса
LD-CHIC16NE-20			czarny / black / чёрный	



Lampka BOSTON Lamp BOSTON Лампа BOSTON

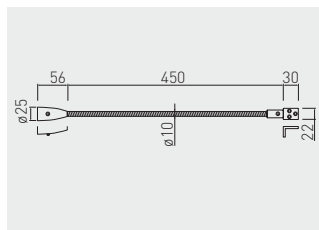



Wymaga zasilacza 12 V, 6 W
Requires 12 V, 6 W power supply
Требуется блок питания 12 В, 6 Вт

LD-BOS1CBWG-53	90 lm	● 3000 K	aluminium	stal, aluminium, tworzywo steel, aluminium, plastic сталь, алюминий, пластмасса
LD-BOS1CBWB-53			aluminium алюминий	

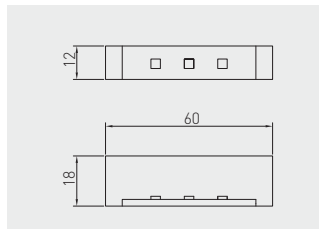

Klip plastikowy LED do półek
Plastic LED clip for shelves
Пластиковая клипса LED для стеклянных полок



			
LD-KLPCB-00N	10 lm	● 3200 K	tworzywo plastic plastik
LD-KLPNB-00N	-	niebieski / blue / синий	
LD-KLPZB-00N	12 lm	● 6200 K	



Klip metalowy LED do półek
Metal LED clip for shelves
Металлическая клипса LED для стеклянных полок

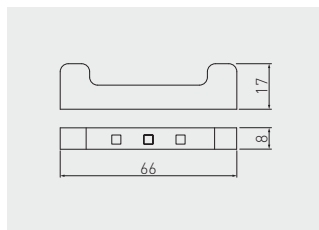

			
LD-3SKL-CBN	10 lm	● 3200 K	stal steel сталь
LD-3SKL-NBN	-	niebieski / blue / синий	
LD-3SKL-ZBN	12 lm	● 6200 K	



Оправа punktowa wpuszczana
 Recessed spot fixture
 Точечный светильник, врезной

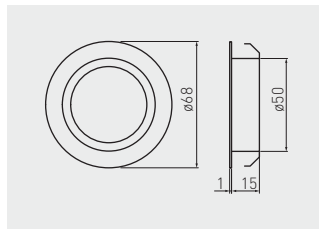

OM-OPW000-61	max.20 W	stare zloto / antique gold / старое золото	stal steel сталь



Zestaw opraw halogenowych
 Halide lamp fixture set
 Комплект галогенных светильников

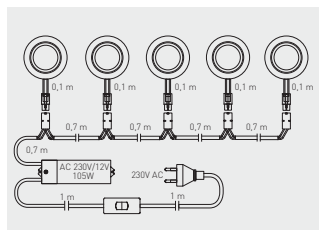



OM-ZH5200-53	max.5x20 W	aluminium / aluminium / алюминий	stal, tworzywo steel, plastic сталь, пластмасса





Zasilacz LED
Power supply
Блок питания для светодиодных светильников

			
LD-ZAS06W-30N	max 6 W	tworzywo plastic пластик	 107 x 39 x 25
LD-ZAS12W-30N	max 12 W		 122 x 45 x 25
LD-ZAS15W-30N	max 15 W		 122 x 45 x 25
LD-ZAS50W-30N	max 50 W		 169 x 48 x 31
LD-ZAS75W-30	max 75 W		 180 x 52 x 30



Zasilacz LED PRO
LED PRO power supply
Светодиодный трансформатор LED PRO

NEW

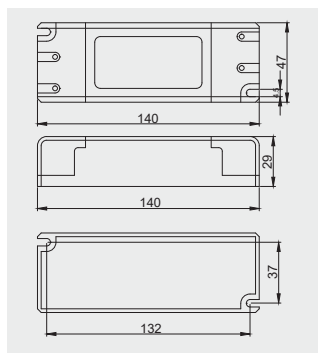

		
LD-ZASPRO33W-30	33 W	tworzywo / plastic / пластик





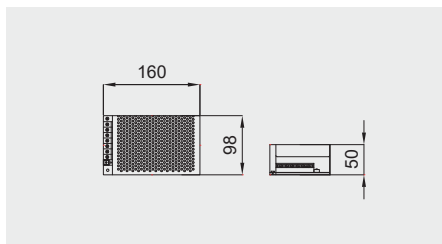

Zasilacz LED

Power supply

Блок питания для светодиодных светильников



			
LD-ZAS150-NW	max 150 W	160 x 98 x 50	aluminium aluminium алюминий





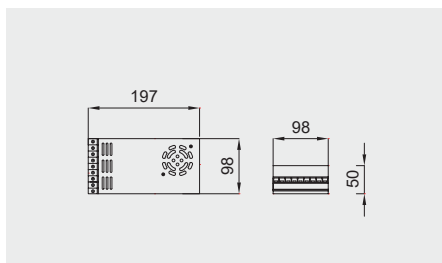

Zasilacz LED

Power supply

Блок питания для светодиодных светильников



			
LD-ZAS350-NW	max 350 W	197 x 98 x 50	aluminium aluminium алюминий



Zasilacz LED puszkowy
LED power supply
Светодиодный трансформаторLED

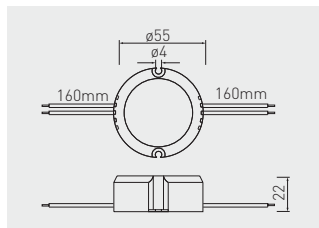

LD-ZASPU15W-30N	15 W	tworzywo / plastic / пластик
-----------------	------	------------------------------



Układ zasilający do klipów LED 5-punktowy
Power supply set for 5 LED clips
Блок питания для светодиодных клипс, 5 разъёмов

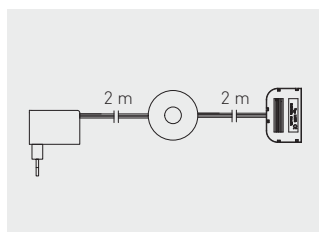

LD-ZSKL15-00	tworzywo / plastic / пластик
--------------	------------------------------



Układ zasilający
Power supply set
Блок питания

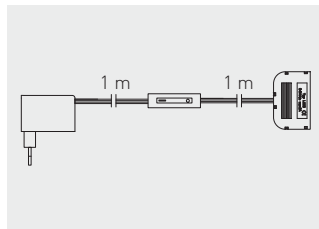

LD-ZWND6W-10	max 6 W	tworzywo plastic пластик
LD-ZWND12-10	max 12 W	



Układ zasilający z przewodami bez włącznika i dystrybutorem 6x mini amp
Power supply without switch, with 6x mini AMP distributor
Блок питания с проводами и дистрибьютором 6x мини амр, без выключателя

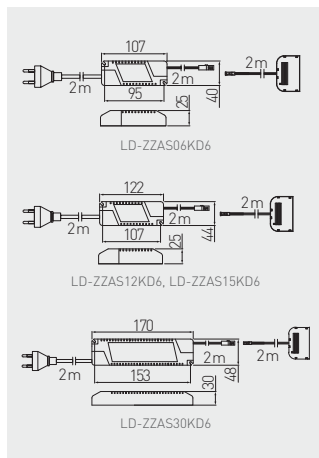
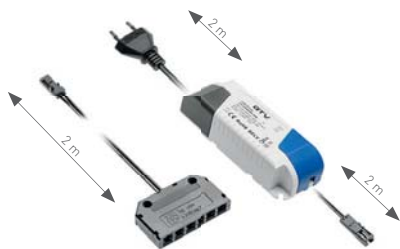

LD-ZZAS06KD6	6 W	tworzywo plastic пластик
LD-ZZAS12KD6	12 W	
LD-ZZAS15KD6	15 W	
LD-ZZAS30KD6	30 W	



Transformator elektroniczny do żarówek halogenowych
 Electronic power supply for halogen lamp
 Электронный трансформатор для галогенной лампы

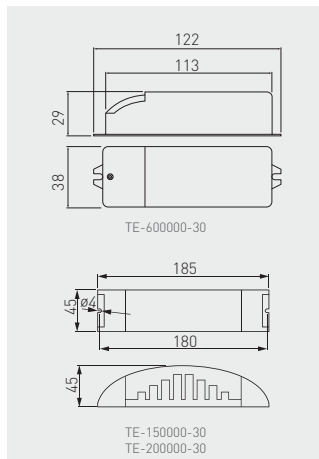

TE-600000-30	max 60 W	tworzywo plastic пластик
TE-150000-30	max 150 W	
TE-200000-30	max 200 W	



Kontroler RGB mini z pilotem
 Mini RGB controller with remote
 Миниконтроллер RGB с пультом

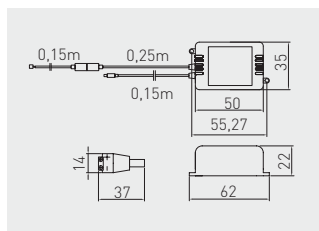

LD-KONMINI-RGB	RGB	tworzywo / plastic / пластик



Kontroler RGB z pilotem
 RGB controller with remote
 RGB контроллер с пультом

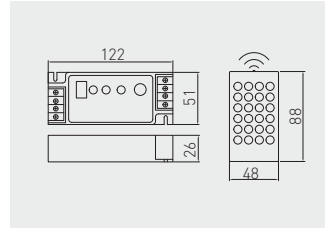

LD-KONRGB-00	RGB	tworzywo / plastic / пластик



Zestaw RGB - kontroler, zasilacz LED 6W, pilot i dystrybutor
 RGB kit - RGB controller, power supply, remote and distributor
 Комплект RGB – контроллер, трансформатор 6W, пульт, дистрибьютор

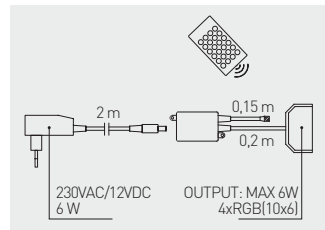

LD-ZAC6WDE-RGB	RGB	tworzywo / plastic / пластик



Zestaw RGB, taśma LED 5 m, kontroler, zasilacz, pilot
 RGB-set, LED band 5 m, RGB controller, LED-transformator, pilot
 Комплект RGB, лента LED 5 м, контролер, трансформатор, пульт

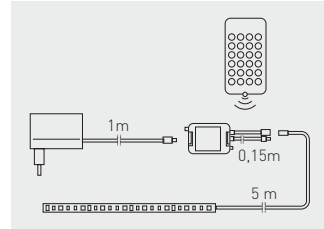

LD-ZL5RGB150-00	RGB	tworzywo / plastic / пластик

Kontroler 1-strefowy MONO
 1-zone controller MONO
 1-х зонный контроллер MONO

NEW

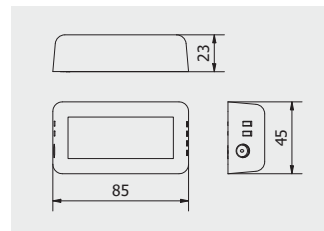

LD-KONML-MONO	RGB	tworzywo / plastic / пластик

Kontroler 1-strefowy RGBW
1-zone controller RGBW
1-х зонный контроллер RGBW

NEW

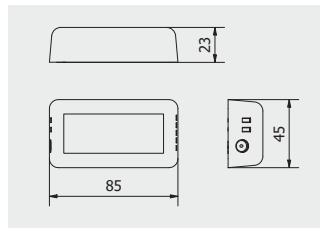

LD-KONML-RGBW

RGB

tworzywo / plastic / пластик



Kontroler WiFi
WiFi-Controller
WiFi - контроллер

NEW

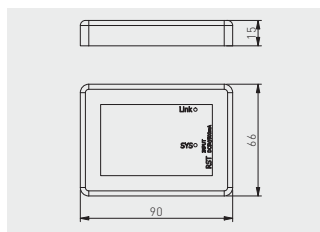

LD-KONML-WIFI

RGB

tworzywo / plastic / пластик



Pilot 4-strefowy MONO
 4-Zone remote controller MONO
 4-зонный пульт дистанционного управления MONO

NEW

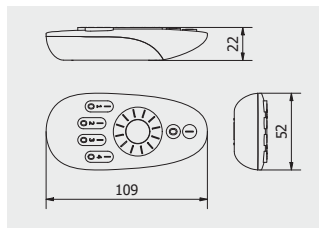





	
LD-KONML-MONO-PIL	tworzywo / plastic / пластик

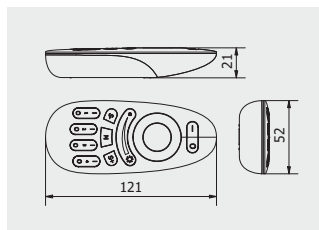

Pilot 4-strefowy RGBW
 4-Zone remote controller RGBW
 4-зонный пульт дистанционного управления RGBW

NEW



		
LD-KONML-RGBW-PIL	RGB	tworzywo / plastic / пластик



Panel dotykowy 4-strefowy na baterie MONO
 Battery powered 4-zone touch panel MONO
 4-зонная сенсорная панель с батарейками MONO

NEW

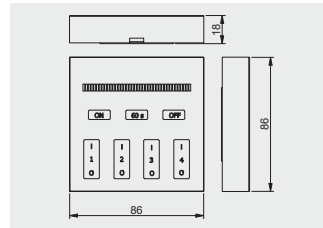

LD-KONML-MONO-PAN

tworzywo / plastic / пластик



Panel dotykowy 4-strefowy na baterie RGBW
 Battery powered 4-zone touch panel RGBW
 4-зонная сенсорная панель с батарейками RGBW

NEW

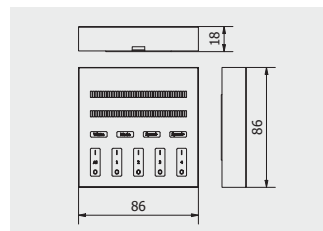

LD-KONML-WRGB-PAN

RGB

tworzywo / plastic / пластик



Adapter do pilota
Remote control adapter
Адаптер пульта дистанционного управления

NEW

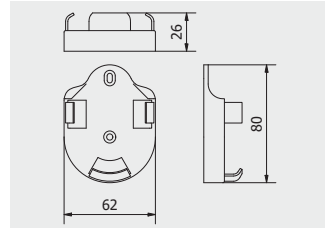

LD-KONML-AD

biały / white / белый

tworzywo / plastic / пластик



Ładowarka indukcyjna z zasilaczem
Wireless charger with power supply
Беспроводное зарядное устройство с блоком питания

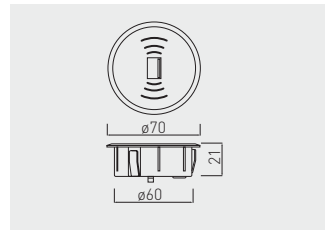

AE-ZUSB-20

czarny / lack / чёрный

tworzywo / plastic / пластмасса



Ładowarka bezprzewodowa, podblatowa z zasilaczem
 Wireless surface charger
 Беспроводное зарядное устройство, под столешницу

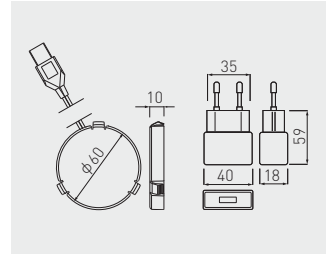

AE-ZLADPOD-20	czarny black чёрный	tworzywo plastic пластмасса



Włącznik bezdotkowy
 Touchless switch
 Бесконтактный датчик

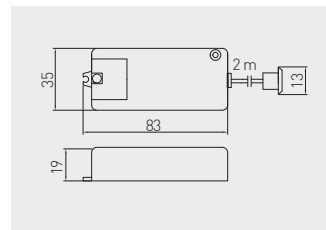

AE-WBEZDC-10S	dwubiegowy two-pole двухфункциональный	tworzywo plastic пластик
AE-WBEZDB-10S	jednobiegowy single-pole однофункциональный	



Włącznik dotykowy pod śrubę
 Touch switch under screw
 Сенсорный выключатель под винт

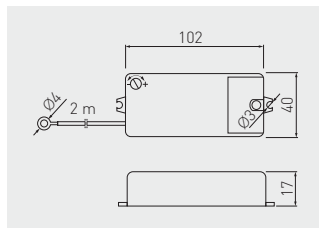

AE-WBEZDK15-10

tworzywo
 plastic
 пластмасса



Włącznik z czujnikiem ruchu PIR
 Switch with PIR motion detector
 Выключатель с датчиком движения PIR

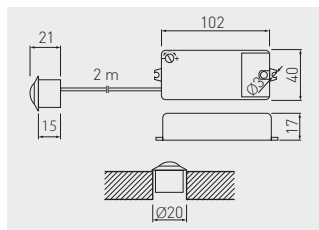

AE-WBEZDPIR-10

tworzywo
 plastic
 пластмасса



Włącznik z dwoma sensorami ruchu PIR II
 Switch with two PIR II motion sensors
 Выключатель с двумя датчиками движения PIR II

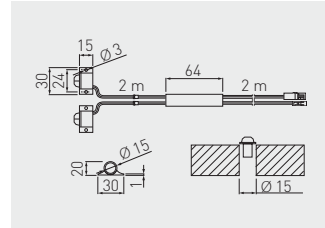

AE-WBEZDPIR2-20

tworzywo
plastic
пластмасса



Włącznik bezdotkowy uniwersalny 3 w 1
 3 in 1 all-purpose touchless switch
 Бесконтактный выключатель 3 в 1

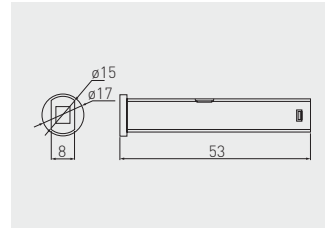

AE-ADCUNI-10

AE-ADBUNI-10



AE-WBBUNI-10DIM

biały / white / белый

tworzywo
plastic
пластик

AE-WBCUNI-10DIM

czarny / black / чёрный





dimnable

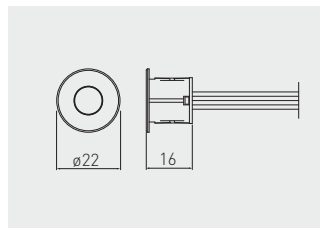

Włącznik dotykowy ściemniający
Dimmable touch switch
Выключатель с регулятором яркости



		
AE-WDSB-10DIM	biały / white / белый	tworzywo plastic пластик
AE-WDSC-10DIM	czarny / black / чёрный	



Włącznik dotykowy ściemniający
Dimmable touch switch
Выключатель с регулятором яркости

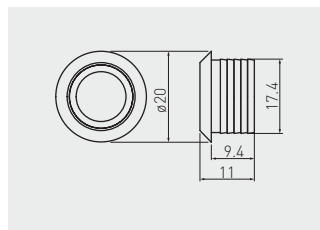

		
AE-WBEZD-NB	chrom chrome хром	tworzywo plastic пластик



Włącznik podblatowy
Countertop switch
Выключатель под столешницу

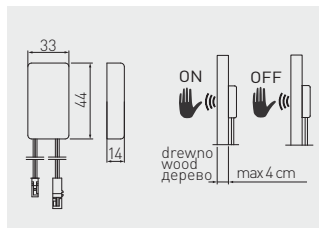

Grubość blatu max 40 mm
Countertop thickness max 40 mm
Толщина столешницы макс. 40 мм

AE-WPDRW-00	tworzywo / plastic / пластик



Włącznik do taśm LED montowany w profil
Switch for LED strips mounted in profile
Выключатель для ленты LED

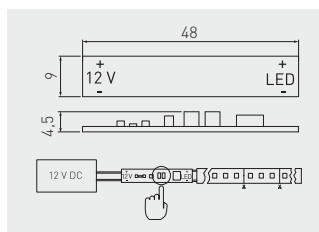

AE-WLPR-60	-	biały white белый	płytkę elektroniczną circuit board электронная плата	1000
AE-WLPR-60P2	2 m			500



Włącznik kotłowy
Switch
Выключатель кнопочный

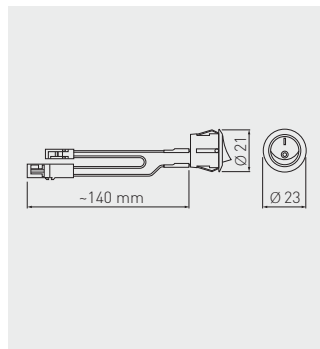

AE-WLB01-10	biały / white / белый	tworzywo plastic пластик
AE-WLC01-20	czarny / black / чёрный	



Włącznik, regulator światła
Switch, colour temperature controller
Выключатель, регулятор цветовой температуры

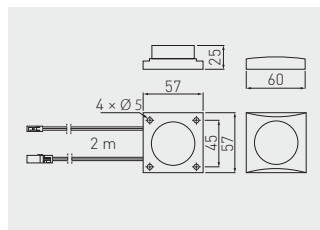

AE-WLKON-20	czarny black чёрный	tworzywo plastic пластмасса



Ściemniacz LED
LED dimmer
Светодиодный диммер

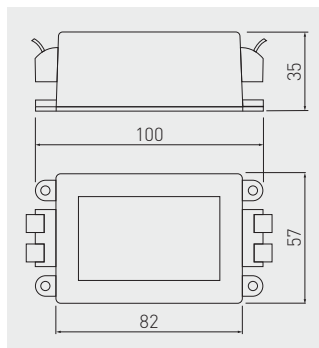

LD-DIMLED-10



czarny / black / чёрный



PC



Włącznik łańcuszkowy
Pull chain switch
Выключатель для бра и торшеров с цепочкой

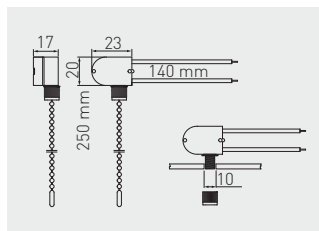

AE-WLLAN1-10



chrom / chrome / хром



tworzywo / plastic / пластик



Kabel zasilający z wtyczką i włącznikiem
 Cable with plug & switch
 Кабель с вилкой и выключателем

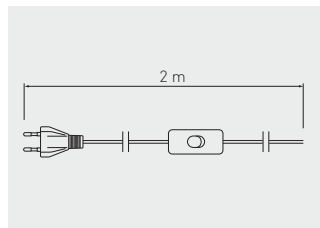

		
LD-KABE2M-00	biały / white / белый	tworzywo / plastic / пластик



Przewód ze złączkami mini AMP
 Cable with Mini AMP
 Кабель с соединителями мини-AMP

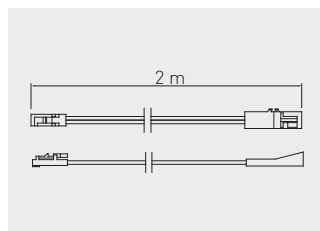

		
LZ-KAPR2M-10	czarny / black / чёрный	tworzywo / plastic / пластик



Złącza do oświetlenia ledowego z dystrybutorem, 3 gniazda
 LED lamp connector with distributor, 3 sockets
 Соединитель LED с распределителем, 3 гнезда

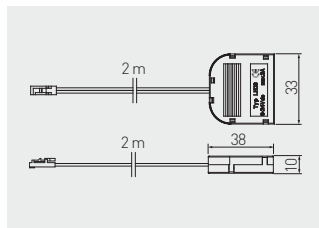

LZ-AKZ312-10N

czarny / black / чёрный

tworzywo / plastic / пластик



Złącza do oświetlenia ledowego z dystrybutorem, 6 gniazda
 LED lamp connector with distributor, 6 sockets
 Соединитель LED с распределителем, 6 гнезд

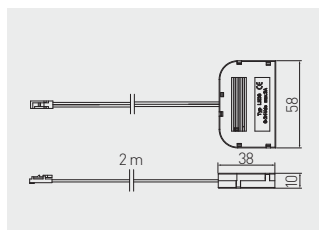

LZ-AKZ612-10N

czarny / black / чёрный

tworzywo / plastic / пластик



Złącza XC11 do taśm LED Connector XC11 for LED strips Соединитель XC11 для лент LED



LD-ZTL8MM-02N



LD-ZTL8MM-02N600



LD-ZTL10MM-02N



LD-ZTLRGB-04N

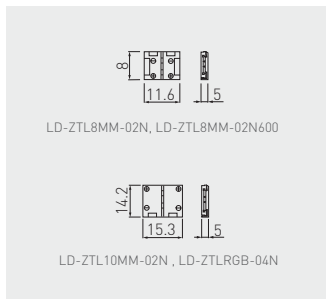

LD-ZTL8MM-02N	8 mm	tworzywo plastic пластик
LD-ZTL8MM-02N600	8 mm / 600 LED	
LD-ZTL10MM-02N	10 mm	
LD-ZTLRGB-04N	RGB	



Złącza XC11 do taśm LED kątowna Angular connector XC11 for LED strips Угловой соединитель XC11 для лент LED



LD-ZTKT8MM-02N



LD-ZTKT8MM-02N600



LD-ZTKT10MM-02N



LD-ZTKTRGB-02N

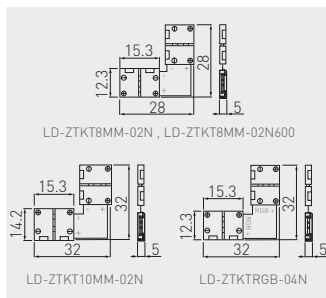

LD-ZTKT8MM-02N	8 mm	tworzywo plastic пластик
LD-ZTKT8MM-02N600	8 mm / 600 LED	
LD-ZTKT10MM-02N	10 mm	
LD-ZTKTRGB-04N	RGB	



Złącza XC11 do taśm LED z przewodem 15 cm
 Connector XC11 with 15 cm cord, for strips
 Соединитель XC11 для лент LED, с проводом 15 см



LD-ZTK8MM-02N LD-ZTK8MM-02N600 LD-ZTK10MM-02N

LD-ZTK8MM-02N	8 mm	tworzywo plastic пластик
LD-ZTK8MM-02N600	8 mm / 600 LED	
LD-ZTK10MM-02N	10 mm	

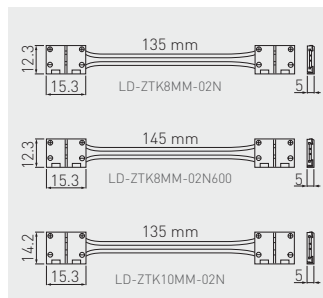

Złącza XC11 do taśm LED z przewodem 2 m
 Connector XC11 with 2 m cord, for LED strips
 Соединитель XC11 для лент LED, с проводом 2 м



LD-ZTL82M-2N LD-ZTL82M-2N600 LD-ZTL102M-2N LD-ZTLRGB2M-4N

LD-ZTL82M-2N	8 mm	tworzywo plastic пластик
LD-ZTL82M-2N600	8 mm / 600 LED	
LD-ZTL102M-2N	10 mm	
LD-ZTLRGB2M-4N	RGB	

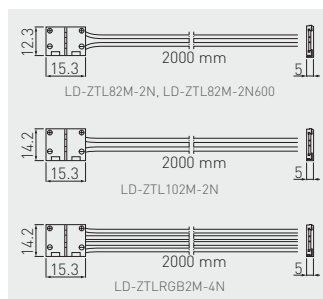

Złącza XC11 do taśm LED z przewodem 2 m i mini amp
 Connector XC11 with 2 m cord and mini AMP, for LED strips
 Соединитель XC11 для лент LED, с проводом 2 м и мини амп

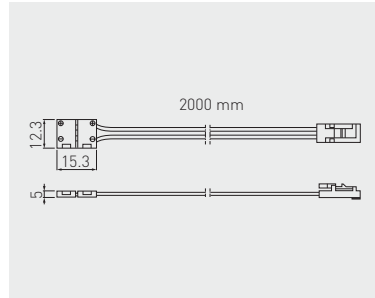

LD-ZTL8MMAMP-02N	8 mm	tworzywo plastic пластик
LD-ZTL8MMAMP-02N600	8 mm / 600 LED	



Złącza XC11 do taśm LED SLIM
 Connector XC11 for LED strips SLIM
 Соединитель XC11 для лент LED SLIM

NEW



LD-ZTLS8MM-02N LD-ZTKS8MM-02N LD-ZTLS82M-2N LD-ZTLS8MMAMP-02N

LD-ZTLS8MM-02N	8 mm	tworzywo plastic пластик
LD-ZTKS8MM-02N		
LD-ZTLS82M-2N		
LD-ZTLS8MMAMP-02N		

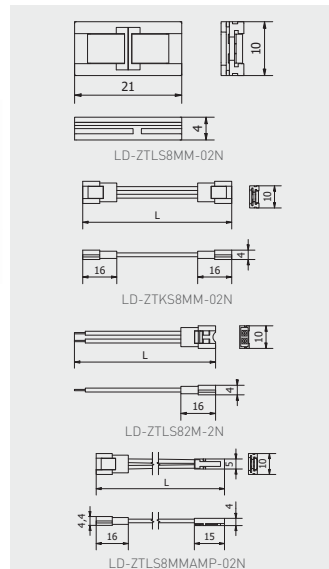

Przedłużacz biurkowy wpuszczany okrągły \varnothing 100
 Pull-out power socket – round \varnothing 100
 Выдвижной настольный удлинитель, круглый \varnothing 100



AE-BPW3GU-80



AE-BPW3GU-20

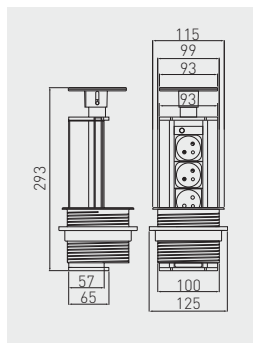

AE-BPW3GU-20	100	french	czarny / black / чёрный	aluminium, tworzywo aluminium, plastic алюминий, пластмасса
AE-BPW3GU-80			srebrny / silver / серебристый	
AE-BPW3GS-20		schuko	czarny / black / чёрный	
AE-BPW3GS-80			srebrny / silver / серебристый	



Przedłużacz biurkowy wpuszczany okrągły \varnothing 60
 Pull-out power socket – round \varnothing 60
 Выдвижной настольный удлинитель, круглый \varnothing 60



AE-BPW3U60-20



AE-BPW3U60-80



AE-BPW3U60U-20



AE-BPW3U60U-80

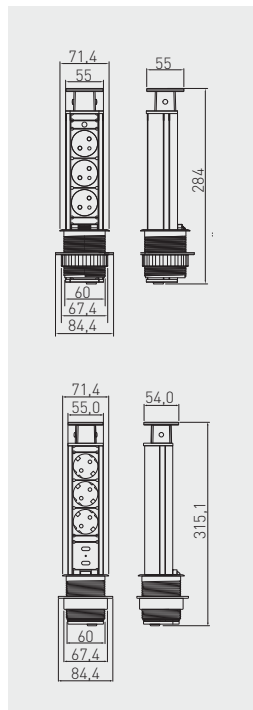

AE-BPW3U60-20	60	french	-	czarny / black / чёрный	aluminium, tworzywo aluminium, plastic алюминий, пластмасса	
AE-BPW3U60-80				srebrny / silver / серебристый		
AE-BPW3S60-20		schuko		czarny / black / чёрный		
AE-BPW3S60-80				srebrny / silver / серебристый		
AE-BPW3U60U-20		french		5V USB max 2A		czarny / black / чёрный
AE-BPW3U60U-80						srebrny / silver / серебристый
AE-BPW3S60U-20		schuko				czarny / black / чёрный
AE-BPW3S60U-80						srebrny / silver / серебристый



Przedłużacz biurkowy wpuszczany ELITE Pull-out power socket ELITE Выдвижной настольный удлинитель ELITE

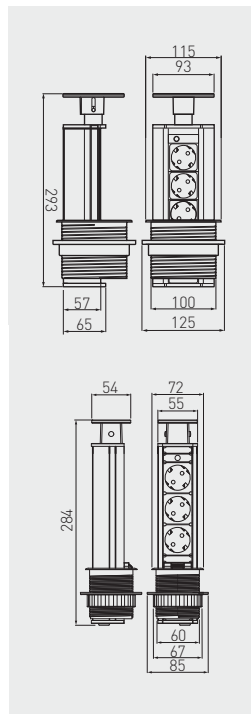

AE-BPWE3GS-00	100	schuko	-	srebrny silver серебристый	aluminium, tworzywo aluminium, plastic алюминий, пластмасса	8			
AE-BPWE3GU-00		french	-						
AE-BPWE3S60-00	60	schuko	-					5V USB max 2A	10
AE-BPWE3S60U-00			-						
AE-BPWE3U60-00		french	5V USB max 2A					-	
AE-BPWE3U60U-00								-	



Pokrywka i pierścień do przedłużaczy ELITE Cap and ring for pull-out power socket ELITE Крышка для удлинителя ELITE

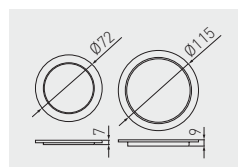

AE-CAP100-40	100	chrom / chrome / хром			stal steel сталь	20
AE-CAP100-51		stal szorstkowana / brushed steel / шлифованная сталь				
AE-CAP60-40	60	chrom / chrome / хром			stal steel сталь	70
AE-CAP60-51		stal szorstkowana / brushed steel / шлифованная сталь				

Przedłużacz biurkowy wpuszczany prostokątny
 Rectangular pop-up power and connection socket
 Настольный удлинитель, прямоугольный, врезной

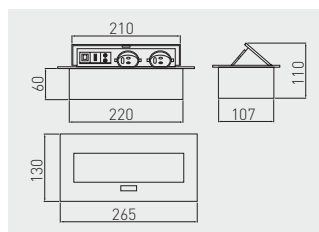

AE-PB02GS-53	schuko	-	aluminium aluminium алюминий	stal, tworzywo steel, plastic сталь, пластмасса
AE-PB02GU-53	french	-		
AE-PBC2GU-53	french	1,5 m		



Przedłużacz biurkowy wpuszczany prostokątny
 Rectangular pop-up power and connection socket
 Настольный удлинитель, прямоугольный, врезной

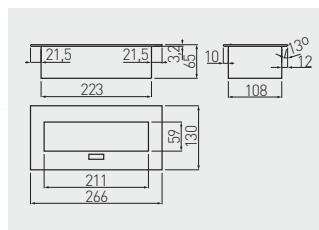

AE-PB03GS-53	schuko	-	aluminium aluminium алюминий	stal, tworzywo steel, plastic сталь, пластмасса
AE-PB03GU-53	french	-		
AE-PBC3GU-53	french	1,5 m		
AE-PBC3GU-20	french	1,5 m	czarny / black / чёрный	
AE-PBC3GU-10	french	1,5 m	biały / white / белый	



Przedłużacz biurkowy wpuszczany prostokątny
 Rectangular pop-up power and connection socket
 Настольный удлинитель, прямоугольный, врезной



AE-PBU2GU-20



AE-PBU2GU-10

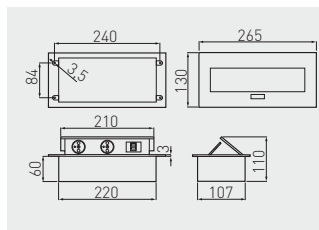

AE-PBU2GU-10	french	biały / white / белый	stal, tworzywo steel, plastic сталь, пластмасса
AE-PBU2GU-20		czarny / black / чёрный	
AE-PBU2GU-53		aluminium / aluminium / алюминий	



Przedłużacz biurkowy kątowny
 Corner power socket
 Настольный удлинитель, угловой



AE-PBKT4S-80



AE-PBKT3U2U-80

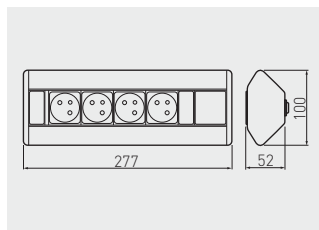

AE-PBKT4U-80	french	-	srebrny silver серебристый	aluminium, tworzywo aluminium, plastic алюминий, пластмасса
AE-PBKT4S-80	schuko			
AE-PBKT3U2U-80	french	5V USB max 2A		
AE-PBKT3S2U-80	schuko			



Przedłużacz biurkowy MULTI
Power socket MULTI
Настольный удлинитель MULTI



AE-PBMUL6U6U-53

AE-PBMUL6S6U-53

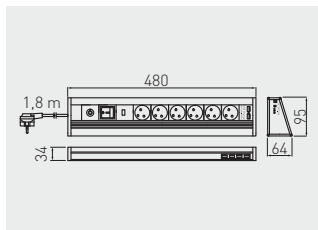

AE-PBMUL6U6U-53	french	aluminium aluminium алюминий	aluminium, tworzywo aluminium, plastic алюминий, пластмасса
AE-PBMUL6S6U-53	schuko		



Przedłużacz biurkowy wpuszczany CHARGER
Desk recessed power socket CHARGER
Настольный удлинитель, встраиваемый CHARGER



AE-BPW1S2UCH-80

AE-BPW1U2UCH-80

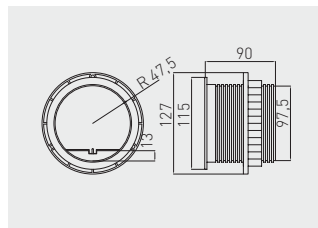

AE-BPW1S2UCH-80	100	schuko	srebrny silver серебристый
AE-BPW1U2UCH-80		french	



Przedłużacz biurkowy wpuszczany CHARGER MINI
 Desk recessed power socket CHARGER MINI
 Настольный удлинитель, встраиваемый CHARGER MINI



AE-BPW1S1UCH-53

AE-BPW1U1UCH-53

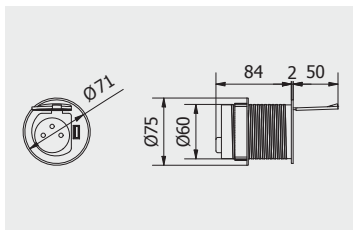

AE-BPW1U1UCH-53	60	french	aluminium aluminium алюминий	aluminium, tworzywo aluminium, plastic алюминий, пластмасса
AE-BPW1S1UCH-53		schuko		



Przedłużacz biurkowy bez kasety
 Through-desk power socket without housing
 Настольный удлинитель без корпуса



AE-PBC3GS-51BK

AE-PBC3GU-51BK

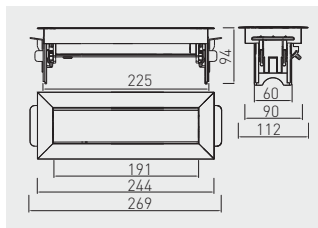

AE-PBC3GS-51BK	schuko	stal szcztokowana brushed steel шлифованная сталь	stal, aluminium, tworzywo steel, aluminium, plastic сталь, алюминий, пластмасса
AE-PBC3GU-51BK	french		



Przedłużacz biurkowy przepustowy z USB Through-desk power socket letterbox brush cable access with USB Настольный удлинитель с пропуском под кабель с USB

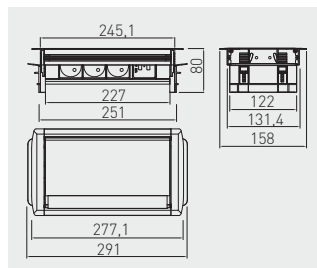

AE-PBC3GS-53BKS	schuko	-	aluminium aluminium алюминий	aluminium, tworzywo aluminium, plastic алюминий, пластмасса
AE-PBC3GU-53BKS	french	-		
AE-PBC3GS2U-53BKS	schuko	5V USB max 2A		
AE-PBC3GU2U-53BKS	french	5V USB max 2A		



Przedłużacz biurkowy przepustowy z HDMI Through-desk power socket letterbox brush cable access with HDMI port Настольный удлинитель с пропуском под кабель, с выходом HDMI

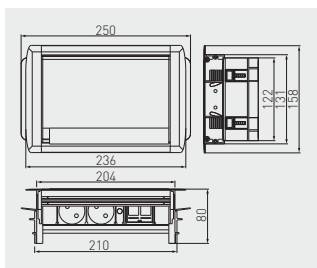

AE-PBC2GS1HDMI-53BKS	schuko	1 x HDMI	aluminium aluminium алюминий	aluminium, tworzywo aluminium, plastic алюминий, пластмасса
AE-PBC2GU1HDMI-53BKS	french			



Przedłużacz biurkowy wpuszczany COMFORT
 Desk recessed power socket COMFORT
 Настольный удлинитель, встраиваемый COMFORT

NEW



AE-BPW3S100U-53

AE-BPW4U100-53

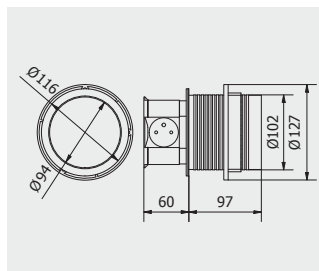

Folder	Symbol	Icon	Info	Warning	Recycling
AE-BPW4U100-53	100	french	-	aluminium aluminium алюминий	aluminium, tworzywo aluminium, plastic алюминий, пластмасса
AE-BPW4S100-53		schuko			
AE-BPW3U100U-53		french	5V USB max 2A		
AE-BPW3S100U-53		schuko			



Przedłużacz biurkowy wpuszczany z HDMI
 Desk recessed power socket with HDMI port
 Настольный удлинитель, встраиваемый с выходом HDMI

NEW



AE-PB02GSHDMI-53

AE-PBC2GUHDMI-53

AE-PBC2GSHDMI-53

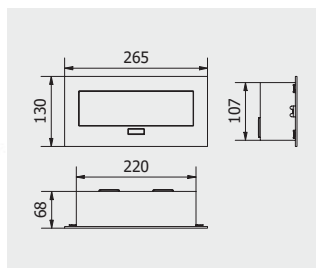

Folder	Symbol	Info	Warning	Recycling
AE-PB02GSHDMI-53	schuko	1 x HDMI, 1 x USB, 1 x RJ45	-	aluminium aluminium алюминий
AE-PBC2GUHDMI-53	french	1 x HDMI	1,5 m	
AE-PBC2GSHDMI-53	schuko			



Przedłużacz biurkowy wpuszczany SOFT
 Desk recessed power socket SOFT
 Настольный удлинитель, встраиваемый SOFT

NEW



AE-PBSC3GS-20



AE-PBSUC2GS-20



AE-PBSC3GS-53



AE-PBSUC2GS-53

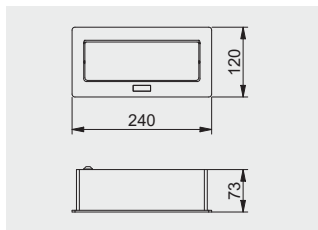

AE-PBSC3GS-10	3 x schuko	-	aluminium aluminium алюминий	aluminium, tworzywo aluminium, plastic алюминий, пластмасса	
AE-PBSC3GS-20					
AE-PBSC3GS-53					
AE-PBSC3GU-10	3 x french				
AE-PBSC3GU-20					
AE-PBSC3GU-53					
AE-PBSUC2GS-10	2 x schuko				5V USB max 2A
AE-PBSUC2GS-20					
AE-PBSUC2GS-53					
AE-PBSUC2GU-10	2 x french				
AE-PBSUC2GU-20					
AE-PBSUC2GU-53					



Przedłużacz biurkowy wpuszczany SLIDE
 Desk recessed power socket SLIDE
 Настольный удлинитель, встраиваемый SLIDE

NEW



AE-BPW1U1UCH-51

AE-BPW1S1UCH-51

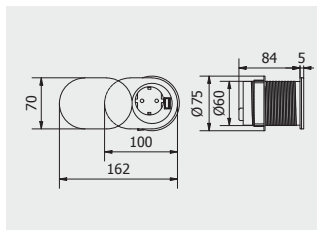













































AE-BPW1U1UCH-51	schuko	USB 5V / 2,4A	aluminium aluminium алюминий	tworzywo plastic пластмасса
AE-BPW1S1UCH-51	french			



OBJAŚNIENIA IKON / ICONS EXPLANATION / ОПИСАНИЕ ИКОНОК

	indeks index индекс		szerokość width ширина		dotatkowe informacje additional information дополнительная информация
	wysokość prowadnika guide height высота чашки		wymiary (mm) dimensions (mm) размеры (мм)		stopień ochrony IP protection rating IP степень защиты IP
	wkręty zwykłe wood screws саморезы		wymiary (m) dimensions (m) размеры (м)		odległość cięcia cutting distance длина отрезка
	euro wkręty euro screws евро саморезы		grubość thickness толщина		szerokość taśmy strip width ширина ленты
	pokrycie finish покрытие		szerokość zewnętrzna szafki outside width of the cabinet наружная ширина ящика		USB USB USB
	kolor color цвет		materiał material материал		rodzaj gniazda socket type тип гнезда
	obciążenie load нагрузка		wyśuw extension выдвижение		moc power номинальный режим
	pojemność capacity емкостительность		kształt shape форма	Akcesoria meblowe Furniture accessories Мебельная фурнитура	
	siła oporu strenght сила опоры		strumień świetlny luminous flux номинальный световой поток		zawias nakładany overlay door накладная петля
	długość length длина		długość przewodu wire length длина провода		zawias bliźniaczy twin overlay полунакладная петля
	rozstaw size межцентровое расстояние		ilość diod number of diodes количество диод		zawias wpuszczany inset door вкладная петля
	wysokość height высота		kolor obudowy housing color цвет корпуса		zawias kątowy corner hinge угловая петля
	strata wysuwu extension loss потеря выдвижения		temperatura barwowa światła color temperature температура оттенка света		zawias o szerokim kącie otwarcia wide angle hinge петля с широким углом открывания
	średnica diameter диаметр		kąt świecenia beam angle угол свечения		zawias równoległy parallel hinge петля под фальшьпанель (равнолежащая)

	zawias równoległy nakładany parallel hinge for overlay door петля накладная под фальшпанель		SLIDE-ON sposób montażu slide-on slide-on mounting надвижной монтаж slide-on		PUSH push-to-open
	zawias uzupełniający complementary hinge петля для складных дверей		SLOW zawias z mechanizmem cichego domyku hinge with soft closing петля с доводчиком Soft Close		FULL pełny wysuw full extension полное выдвижение
	regulacja adjustment регулировка		zawias ze sprężyną dociągającą hinge with closing spring петля с прижимной пружиной		szuflada standard standard drawer стандартный ящик
	działanie jednopunktowe single action hinge одношаговая петля		zawias ze sprężyną samootwierającą self-opening hinge петля самооткрывающаяся		szuflada standard zlewozmywakowa under sink drawer ящик под мойку
	działanie dwupunktowe double action hinge двухшаговая петля		zawias bez sprężyny hinge without spring петля без пружины		szuflada narożna corner drawer ящик угловой
	SPECIAL zawias do zastosowań specjalnych special hinge петля для специальных конструкций		A szuflada niska low drawer низкий ящик		szuflada standardowa standard drawer стандартный ящик
	Ø 35 mm średnica puszki hinge cup diameter диаметр чашки		B szuflada średnia medium drawer средний ящик		szuflada wewnętrzna inner drawer внутренний ящик
	45 mm rozstaw otworów puszek hinge cup drilling spacing межцентровое расстояние отверстий на чашке		C szuflada wysoka high drawer высокий ящик		przewodnica dolnego montażu under mount drawer направляющая нижнего монтажа
	montaż puszek na wkręty do drewna wood screw hinge cup mounting монтаж чашки на саморезы по дереву		regulacja pion i poziom vertical and horizontal adjustment регулировка по ширине и высоте		przewodnica kulkowa ball-bearing slide шариковая направляющая
	montaż przewodnika na wkręty do drewna wood screw mounting plate installation установка ответной планки на саморезы по дереву		opcja wypięcia release option снятие ящика без инструментов		przewodnica rolkowa roller slide роликовая направляющая
	montaż przewodnika na wkręty euro euro screw mounting plate installation установка ответной планки на евроинты		H=83 wysokość boku MB Square drawer side height MB Square высота боковой стенки MB Square		metalbox metalbox металбок
	montaż przewodnika na kolki dowel mount hinge монтаж чашки на саморезы с дюбелями		H=83 wysokość boku MB drawer side height MB высота боковой стенки MB		SLOW cichy domyk quiet shut бесшумное закрытие
	regulacja mimośrodowa eccentric adjustment эксцентриковая регулировка		H=95 wysokość boku AXIS drawer side height AXIS высота боковой стенки AXIS		SELF CLOSING samodociąg self closing доводчик
	x 100 pakowanie packing упаковка		3D dostępna bryła 3D 3D model available есть 3D модель		montaż nasuwany ze sprzęgłem push mounting with locking device надвижной монтаж с креплением фасада
	CLIP-ON sposób montażu clip-on clip-on mounting быстрый монтаж clip-on		CERTIFICATE 60.000 trwałość tested durability кол-во циклов откр./закр.		montaż nakładany put on mounting накладной монтаж



Oświetlenie meblowe Furniture lighting Мебельное освещение

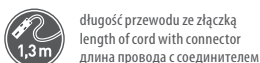
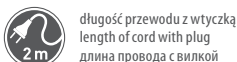
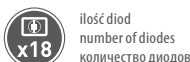
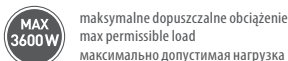
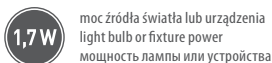
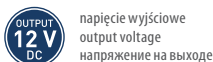
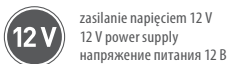
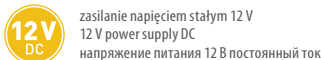
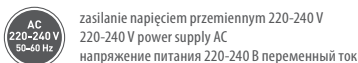
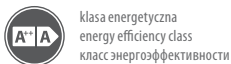



rodzaj złączki
type of connector
тип соединителя



temperatura pracy
working temperature
рабочая температура



rodzaj złączki
type of connector
тип соединителя



gniazdo USB
USB port
USB – порт



stopień ochrony IP
international protection marking
пылевлагозащита IP



maksymalne obciążenie gniazd USB
max load USB ports
максимальная нагрузка портов USB



współczynnik oddawania barw
colour rendering index
индекс цветопередачи



gniazdo UK
UK socket
гнездо UK



współczynnik mocy
power factor
коэффициент мощности



ethernet
ethernet port
ethernet – порт



liczb cykli wł./wył.
switching cycle
количество циклов вкл./выкл.



nie współpracuje ze ściemniaczami
non-dimmable
нет возможности подключения диммера



włącznik dotykowy ściemniający
dimnable touch switch
выключатель с регулятором яркости



współpracuje ze ściemniaczami
dimnable
есть возможность подключения диммера



oprawa z włącznikiem
fixture with switch
светильник с выключателем



montaż na ścianie / suficie
application: indoor / ceiling mounted
монтаж на стене / потолке



sterowanie pilotem (IR/RF)
remote control (IR/RF)
управление с помощью пульта (ИР/РФ)



rekomendowana odległość montażu od powierzchni
recommended mounting distance from surfaces
рекомендуется монтаж устройства на расстоянии



włącznik bezdotykowy dwubiegowy
two-pole touchless switch
бесконтактный переключатель / двухфункциональный



średnica otworu montażowego
mounting hole diameter
монтажное отверстие диаметром



włącznik do szafy / jednobiegowy
single-pole touchless switch
переключатель для шкафов / однофункциональный



akumulator
battery
аккумулятор



zasięg czujki ruchu
range of motion sensor
площадь действия сенсора



Maksymalne obciążenie na jeden kanał
Maximum load per channel
Максимальная нагрузка на один канал



czas pracy
nominal lifetime
время работы



Częstotliwość pracy pilota
Remote control frequency
Частота работы пульта



czas włączania
starting time (max)
время включения



Maksymalna rozpraszana moc źródeł światła dla profilu rozgrzanego do maksymalnie 65 stopni C, dla wersji z kloszem.
Maximal dissipated power of lamps for heated profiles to 65°C, when applied with lampshades.
Максимальная рассеиваемая мощность источников света для нагреваемого профиля до максимум 65°C, для версии с абажуром.



trzonek źródła światła G4
base type G4
тип цоколя G4

KOLORY
COLORS
ЦВЕТА



10
biały
white
белый



80
srebrny
silver
серебристый



14
antyczna miedź
antique cooper
античная медь



10M
biały mat
white matt
белый матовый



7
antyczne srebro
antique silver
античное серебро



20
czarny
black
чёрный



mleczny
milk
молочный



19
szary mat
grey matt
серый матовый



20M
czarny mat
black matt
чёрный матовый



CS
kremowy
ecru
экрю



2, 52
satyna
satin
сатин



58
wenge
venge
венге



1, 40
chrom
chrome
хром



6, 51
stal szcztokowana
brushed steel
шлифованная сталь



3
mosiądz
brass
латунь



5, 53
aluminium
aluminium
алюминий



11
tytan szcztokowany
brushed titanium
шлифованный титан



4
antyczny mosiądz
antique brass
античная латунь



30
szary
gray
серый



12
czarny chrom
black chrome
чёрный хром



9
antyczny mosiądz
szcztokowany
antique brushed brass
античная шлифованная латунь



osynek
zink - plated
оцинковка



13
tytan
titanium
титан



16
złoty mosiądz
golden brass
золотая латунь



22
kość stoniowa
ivory
слоновая кость



52
wiśnia
cherry
вишня



RZ
różowy
pink
розовый



17
brąz
bronze
коричневый



42
grusza
pear
груша



PM
pomarańczowy
orange
оранжевый



50
beż
beige
кремовый



30
brąz
brown
коричневый



15
miedź
cooper
медь



7, 31, 732
ciemny brąz
dark brown
темно-коричневый



44
buk
beech
бук



61
ciemny mahoń
dark mahogany
темное красное дерево



41
olcha
alder
ольха



20, 48, 731
mahoń
mahogany
красное дерево



43
jasny brąz
light brown
светло-коричневый



NB
niebieski
blue
синий



51
calvados
calvados
кальвадос



ZL
zielony
green
зеленый

Klasa ochronności na pył, ciała stałe i wodę
Dust, solids & water ingress protection rating
Класс защиты от пыли, твердых тел и воды

IP	Stopień ochrony I Protection rating I Степень защиты I
0	Brak ochrony None Отсутствие защиты
1	Ochrona przed ciałami obcymi stałymi o wielkości ponad 50 mm. Protection against ingress of > 50 mm bodies. Защита от попадания инородных твердых тел размером более 50 мм.
2	Ochrona przed ciałami stałymi przekraczającymi 12 mm. Protection against ingress of > 12 mm bodies. Защита от попадания инородных твердых тел размером более 12 мм.
3	Ochrona przed ciałami stałymi przekraczającymi 2,5 mm. Protection against ingress of > 2.5 mm bodies. Защита от попадания инородных твердых тел размером более 2,5 мм.
4	Ochrona przed ciałami stałymi przekraczającymi 1 mm. Protection against ingress of > 1 mm bodies. Защита от попадания инородных твердых тел размером более 1 мм.
5	Pyłoodporność Protection against ingress of dust Пылестойкость
6	Pyłoszczelność Dustproof Пылестойкость

IP	Stopień ochrony II Protection rating II Степень защиты II
0	Brak ochrony None Отсутствие защиты
1	Ochrona przed pionowo wpadającymi kroplami wody. Protection against dripping water (vertically falling drops). Защита от вертикально падающих капель воды.
2	Ochrona przed kroplami wody przy przechyleniu do 15°. Protection against dripping water when tilted up to 15°. Защита от капель воды, падающих под углом до 15°.
3	Ochrona przed rozpyloną wodą Protection against spraying water. Защита от распыленной воды.
4	Ochrona przed bryzgami wody Protection against splashing of water. Защита от брызг воды.
5	Ochrona przed strugami wody Protection against water jets Защита от струй воды
6	Ochrona przed falami Protection against powerful water jets (waves) Защита от волн
7	Ochrona przed zanurzeniem Protection against immersion Защита от погружения
8	Ochrona przed głębokim zanurzeniem Protection against deep immersion Защита от глубокого погружения

Klasa ochronności przed porażeniem elektrycznym
Electric shock protection class
Класс защиты от поражения электрическим током

Klasa bezpieczeństwa Safety class Класс безопасности	Symbol Symbol Символ	Wyjaśnienie Definition Пояснение
0	Brak None Нет Keine Nincs	<p>Ochronę przed porażeniem elektrycznym stanowi izolacja podstawowa. W przypadku uszkodzenia izolacji ochronę przeciwporażeniową powinny zapewnić odpowiednio korzystne warunki środowiskowe oraz położenie urządzenia poza dotykem bezpośrednim.</p> <p>The protection against electric shock relies on basic insulation only. In the event of insulation failure, electric shock protection shall be assured by suitably favourable environmental conditions and locating the equipment beyond the reach of direct touch.</p> <p>Защиту от поражения электрическим током обеспечивает основная изоляция. В случае повреждения изоляции защиту от поражения электрическим током должны обеспечить соответствующие благоприятные условия окружающей среды и размещение оборудования вне зоны прямого контакта.</p>
I		<p>W urządzeniach z I klasą ochronności bezpieczeństwo zapewnione jest przez połączenie wszystkich czynnych przewodzących elementów z przewodem ochronnym lub bezpośrednio uziemieniem.</p> <p>Class I equipment provides protection by connecting all live conductive parts to a protective wire or directly to earth.</p> <p>В устройствах с I классом защиты безопасность обеспечивается посредством объединения всех действующих проводящих элементов с защитным проводом или непосредственно с заземлением.</p>
II		<p>W urządzeniach z II klasą ochronności bezpieczeństwo zapewnione jest przez zastosowanie izolacji podwójnej lub wzmocnionej, której w danych warunkach środowiskowych i przy napięciu znamionowym uważa się nie do przebicia.</p> <p>Class II equipment provides protection by the use of double or strengthened insulation, which is deemed breakdown-proof under given environmental conditions at the rated voltage.</p> <p>В устройствах с II классом защиты безопасность обеспечивается путем применения двойной или усиленной изоляции, которая в данных условиях окружающей среды и при номинальном напряжении считается непробиваемой.</p>
III		<p>Ochrona przeciwporażeniowa w urządzeniach z III klasy ochronności jest zapewniona przez obniżenie napięcia zasilania do wartości bezpiecznej w danych warunkach środowiskowych.</p> <p>Class III equipment protection against electric shock is provided by reduction of power voltage to a safe limit under given environmental conditions.</p> <p>Защита от поражения электрическим током в устройствах с III классом защиты обеспечивается снижением напряжения питания до безопасного в данных условиях окружающей среды значения.</p>

Indeks

A

		AE-CAP100-40	541	AE-WBEZDB-10S	527	A-K18-300-20M	447
		AE-CAP100-51	541	AE-WBEZDC-10S	527	A-K18-300-90	447
A-B63-32	460	AE-PB02GS-53	542	AE-WBEZDK15-10	528	A-KLP-4	458
A-B63-40	460	AE-PB02GSHDMI-53	547	AE-WBEZD-NB	530	A-KR-4	458
A-BUDP-SET	466	AE-PB02GU-53	542	AE-WBEZDPIR-20	529	A-LD4MOV-300-05	446
A-BUD-UB	466	AE-PB03GS-53	542	AE-WBEZDPIR-10	528	A-LD10-170-05	445
A-BUD-UG466		AE-PB03GU-53	542	AE-WDSB-10DIM	530	A-LD10-235-05	445
A-BUD-UM	466	AE-PBC2GS1HDMI-53BKS		AE-WDSC-10DIM	530	A-LD10-235-90	445
A-BUD-UP466			546	AE-WLB01-10	532	A-LD10-300-05	445
A-BUD-UR466		AE-PBC2GSHDMI-53	547	AE-WLC01-20	532	A-LD10-300-10	445
A-C18-300-S-05		AE-PBC2GU1HDMI-53BKS		AE-WLKON-20	532	A-LD10-300-90	445
	448, 463, 464		546	AE-WLLAN1-10	533	A-LD10-405-05	445
A-C18-300-S-10	448	AE-PBC2GU-53	542	AE-WLPR-60	531	A-LD10-405-90	445
A-C18-300-S-20M	448	AE-PBC2GUHDMI-53	547	AE-WLPR-60P2	531	A-LD10-600-05	445
A-C18-300-S-90	448	AE-PBC3GS2U-53BKS	546	AE-WPDRW-00	531	A-LD10-600-90	445
A-DPG-16	453	AE-PBC3GS-51BK	545	AE-ZLADPOD-20	527	A-LD10FL-235-05	447
AE-BPW1S1UCH-51	549	AE-PBC3GS-53BKS	546	AE-ZUSB-20	526	A-LD10FL-235-90	447
AE-BPW1S1UCH-53	545	AE-PBC3GU2U-53BKS	546	A-H16-300-05	448	A-LD10FL-300-05	447
AE-BPW1S2UCH-80	544	AE-PBC3GU-10	542	A-H16-300-90	448	A-LD10FL-300-10	447
AE-BPW1U1UCH-51	549	AE-PBC3GU-20	542	A-H18-300-05	450	A-LD10FL-300-90	447
AE-BPW1U1UCH-53	545	AE-PBC3GU-51BK	545	A-H18-300-10	450	A-LD18-170-05	443
AE-BPW1U2UCH-80	544	AE-PBC3GU-53	542	A-H18-300-20M	450	A-LD18-170-90	443
AE-BPW3GS-20	539	AE-PBC3GU-53BKS	546	A-H18-300-90	450	A-LD18-235-05	443
AE-BPW3GS-80	539	AE-PBKT3S2U-80	543	A-HR10-235-05	451	A-LD18-235-90	443
AE-BPW3GU-20	539	AE-PBKT3U2U-80	543	A-HR10-300-10	451	A-LD18-300-05	443
AE-BPW3GU-80	539	AE-PBKT4S-80	543	A-HR10-300-90	451	A-LD18-300-10	443
AE-BPW3S60-20	540	AE-PBKT4U-80	543	A-HR10-600-05	451	A-LD18-300-20M	443
AE-BPW3S60-80	540	AE-PBMUL6S6U-53	544	A-HR10-600-90	451	A-LD18-300-90	443
AE-BPW3S60U-20	540	AE-PBMUL6U6U-53	544	A-HR10FL-300-05	452	A-LD18-405-05	443
AE-BPW3S60U-80	540	AE-PBSC3GS-10	548	A-HR10FL-300-10	452	A-LD18-405-10	443
AE-BPW3S100U-53	547	AE-PBSC3GS-20	548	A-HR10FL-300-90	452	A-LD18-405-90	443
AE-BPW3U60-20	540	AE-PBSC3GS-53	548	A-HR18-300-05	450	A-LD18-600-05	443
AE-BPW3U60-80	540	AE-PBSC3GU-10	548	A-HR18-300-10	450	A-LD18-600-90	443
AE-BPW3U60U-20	540	AE-PBSC3GU-20	548	A-HR18-300-20M	450	A-LD19-300-05	444
AE-BPW3U60U-80	540	AE-PBSC3GU-53	548	A-HR18-300-90	450	A-LG4MOV-300-05	445
AE-BPW3U100U-53	547	AE-PBSUC2GS-10	548	A-HR19-300-05	451	A-LG10-170-05	444
AE-BPW4S100-53	547	AE-PBSUC2GS-20	548	A-HRS10-170-05	451	A-LG10-235-05	444
AE-BPW4U100-53	547	AE-PBSUC2GS-53	548	A-HRS10-300-05	451	A-LG10-235-90	444
AE-BPWE3GS-00	541	AE-PBSUC2GU-10	548	A-HRS10-300-90	451	A-LG10-300-05	444
AE-BPWE3GU-00	541	AE-PBSUC2GU-20	548	A-HRS10-405-05	451	A-LG10-300-10	444
AE-BPWE3S60-00	541	AE-PBSUC2GU-53	548	A-HRS10-600-05	451	A-LG10-300-90	444
AE-BPWE3S60U-00	541	AE-PBU2GU-10	543	A-HRS18-235-05	450	A-LG10-405-05	444
AE-BPWE3U60-00	541	AE-PBU2GU-20	543	A-HRS18-300-05	450	A-LG10-405-90	444
AE-BPWE3U60U-00	541	AE-PBU2GU-53	543	A-HRS18-300-90	450	A-LG10-600-05	444
AE-CAP60-40	541	AE-WBBUNI-10DIM	529	A-K18-300-05	447	A-LG10-600-90	444
AE-CAP60-51	541	AE-WBCUNI-10DIM	529	A-K18-300-10	447	A-LG10FL-235-05	446

A-LG10FL-235-90	446	AM-OAM-KR-GM-60	45	A-PTD	456	A-SN-HSET1	464
A-LG10FL-300-05	446	AM-OAM-KR-MG-10	45	A-PTG	455	A-SN-K19-270-05	463, 464
A-LG10FL-300-10	446	AM-OAM-KR-MG-30	45	A-PW-RC-DOC	461	A-SN-LOFT-200-20M	467
A-LG10FL-300-90	446	AM-OAM-KR-MG-60	45	A-R4MOV-270-05	436	A-SN-POZ 464	
A-LG18-170-05	442	AM-ODB000-10	42	A-R10ARCO-270-05	438	A-SN-R19RIV-270-05	
A-LG18-170-90	442	AM-ODB000-60	42	A-R10ARCO-270-90	438		433, 463, 464
A-LG18-235-05	442	AM-OWM-DL-GM-10	44	A-R10FALDA-270-05	438	A-SN-SDP-TU	465
A-LG18-235-90	442	AM-OWM-DL-GM-30	44	A-R10FALDA-270-90	438	A-SN-SOFT-25	463, 464
A-LG18-300-05	442	AM-OWM-DL-GM-60	44	A-R10FL-270-05	436	A-SN-SOFT-40	463, 464
A-LG18-300-10	442	AM-OWM-DL-MG-10	44	A-R10FL-270-10	436	A-SN-TDS-405-00	463
A-LG18-300-20M	442	AM-OWM-DL-MG-30	44	A-R10FL-270-90	436	A-SN-TDT-405-00	464
A-LG18-300-90	442	AM-OWM-DL-MG-60	44	A-R10FORM-270-05	437	A-SN-TG-405-00	463, 464
A-LG18-405-05	442	AM-OWM-KR-GM-10	44	A-R10FORM-270-90	437	A-SO-48X4	456
A-LG18-405-10	442	AM-OWM-KR-GM-30	44	A-R10NOV-270-05	437	A-SO-145X4	456
A-LG18-405-90	442	AM-OWM-KR-GM-60	44	A-R10NOV-270-10	437	A-SO-145X4-10	456
A-LG18-600-05	442	AM-OWM-KR-MG-10	44	A-R10NOV-270-90	437	A-SO-145X4-20	456
A-LG18-600-90	442	AM-OWM-KR-MG-30	44	A-R10TORO-270-05	438	A-SOFT-30	460
A-LG19-300-05	443	AM-OWM-KR-MG-60	44	A-R10TORO-270-90	438	A-SOFT-50	460
AM-ADAP0A-10	43	AM-PLA-DLU-0	46	A-R10TRAFO-270-05	437	A-SP-7X12	457
AM-ADAP0A-60	43	AM-PL-DL-MAG	46	A-R10TRAFO-270-90	437	A-SP-48X7	457
AM-ADAP0B-10	43	A-MPRO-170-05	442	A-R16ERG-270-50	432	A-SP-48X12	457
AM-ADAP0B-60	43	A-MPRO-170-10	442	A-R18CARO-270-05	434	A-T18-300-05	448
A-MEVO-170-05	440	A-MPRO-170-20M	442	A-R18CARO-270-90	434	A-T18-300-10	448
A-MEVO-170-10A	440	A-MPRO-170-90	442	A-R18COTE-270-05	435	A-T18-300-90	448
A-MEVO-170-20M	440	A-MPRO-235-05	442	A-R18COTE-270-90	435	A-TDEVO2-170-05	441
A-MEVO-170-90	440	A-MPRO-235-10	442	A-R18ERG-270-05	432	A-TDEVO2-170-90	441
A-MEVO-235-05	440	A-MPRO-235-20M	442	A-R18ERG-270-90	432	A-TDEVO2-235-05	441
A-MEVO-235-10A	440	A-MPRO-235-90	442	A-R18GE02-270-05	432	A-TDEVO2-235-90	441
A-MEVO-235-20M	440	A-MPRO-300-05	442	A-R18LOCA-305-05	436	A-TDEVO2-300-05	441
A-MEVO-235-90	440	A-MPRO-300-10	442	A-R18LOCA-305-90	436	A-TDEVO2-300-90	441
A-MEVO-300-05	440	A-MPRO-300-20M	442	A-R18NERO-270-05	435	A-TDEVO2-405-05	441
A-MEVO-300-10A	440	A-MPRO-300-90	442	A-R18NERO-270-10	435	A-TDEVO2-405-90	441
A-MEVO-300-20M	440	A-MPRO-405-05	442	A-R18NERO-270-20M	435	A-TDEVO2-600-05	441
A-MEVO-300-90	440	A-MPRO-405-10	442	A-R18NERO-270-90	435	A-TDEVO2-600-90	441
A-MEVO-405-05	440	A-MPRO-405-20M	442	A-R18NOVS-270-05	433	A-TDEVO-170-05	440
A-MEVO-405-10	440	A-MPRO-405-90	442	A-R18NOVS-270-10	433	A-TDEVO-170-10	440
A-MEVO-405-20M	440	AM-PROST-KPL	41	A-R18NOVS-270-20M	433	A-TDEVO-170-20M	440
A-MEVO-405-90	440	AMR-BP-0715	47	A-R18NOVS-270-90	433	A-TDEVO-170-90	440
A-MITO-PLUS	462	AMR-BP-1003	47	A-R18VIS-270-05	434	A-TDEVO-235-05	440
AM-KRZYZ-KPL	42	AMR-WP-00	47	A-R18VIS-270-90	434	A-TDEVO-235-10	440
AM-MBSOFT-P2	91	AMS-MPST001-OC	409	A-R19NERO-300-05	435	A-TDEVO-235-20M	440
AM-OAM-DL-GM-10	45	A-MSOFT-ADAPT	461	A-R19NOVS-300-05	434	A-TDEVO-235-90	440
AM-OAM-DL-GM-30	45	A-MSOFT-RAMA	461	A-RD-MITO	462	A-TDEVO-300-05	440
AM-OAM-DL-GM-60	45	AM-ZAT-A1-10	46	A-RNOV2-270-05	433	A-TDEVO-300-10	440
AM-OAM-DL-GM-10	45	A-PG-18	452	A-RNOV2-270-10	433	A-TDEVO-300-20M	440
AM-OAM-DL-GM-30	45	A-PGR-10	453	A-RNOV2-270-90	433	A-TDEVO-300-90	440
AM-OAM-DL-GM-60	45	A-PGR-10S	453	A-SG-MITO	462	A-TDEVO-405-05	440
AM-OAM-KR-GM-10	45	A-PGR-18	452	A-SN-ADSET	463, 464	A-TDEVO-405-10	440
AM-OAM-KR-GM-30	45	A-POZ-MITO	462	A-SN-FSET	463	A-TDEVO-405-20M	440

A-TDEVO-405-90	440	A-USZCZ-TDEVO2	459	GZ-CLEO-1-05	268	GZ-OLIVA-16-01*	272
A-TDEVO-600-05	440	A-USZCZ-U4	459	GZ-CLEO-1-06	268	GZ-PALER-1-07	334
A-TDEVO-600-10	440	A-WD-EVO454		GZ-CRPA20-01	356	GZ-ROMA-1-01	280
A-TDEVO-600-20M	440	A-WD-EVO2	454	GZ-CRPA20-03	356	GZ-ROMA-1-02	280
A-TDEVO-600-90	440	A-WD-PRO	454	GZ-CRPA20-A1	356	GZ-ROMA-1-05	280
A-TDPRO-170-05	441	A-WDR-EVO	455	GZ-CRPA25-01	356	GZ-ROMA-1-06	280
A-TDPRO-170-10	441	A-WDR-PRO	455	GZ-CRPA25-03	356	GZ-ROYAL3-1-10/03	345
A-TDPRO-170-20M	441	A-ZAC-WDEVO2	454	GZ-CRPA25-A1	356	GZ-SENIOR-1-01	268
A-TDPRO-170-90	441	A-ZAT-TDEVO2	458	GZ-CRPA30-01	356	GZ-SENIOR-1-05	268
A-TDPRO-235-05	441			GZ-CRPA30-03	356	GZ-TERNI-1-01	318
A-TDPRO-235-10	441			GZ-CRPA30-A1	356	GZ-TERNI-1-02	318
A-TDPRO-235-20M	441	B		GZ-CRPA40-01	356	GZ-TERNI-1-05	318
A-TDPRO-235-90	441			GZ-CRPA40-03	356	GZ-TERNI-1-06	318
A-TDPRO-300-05	441	BP-SLZIGW-10	401	GZ-CRPA40-A1	356	GZ-TERNI-1-09	318
A-TDPRO-300-10	441	BP-SLZIGW-21	402	GZ-CRPB20-01	356	GZ-TERNI-1-10	318
A-TDPRO-300-20M	441			GZ-CRPB20-03	356	GZ-TERNI-1-12	318
A-TDPRO-300-90	441			GZ-CRPB20-A1	356	GZ-TERNI-1-20M	318
A-TDPRO-405-05	441	E		GZ-CRPB25-01	356	GZ-UDINE-1-01	317
A-TDPRO-405-10	441			GZ-CRPB25-03	356	GZ-UDINE-1-02	317
A-TDPRO-405-20M	441	EM-SBL060-01	160	GZ-CRPB25-A1	356	GZ-UDINE-1-05	317
A-TDPRO-405-90	441	EM-SBL100-01	160	GZ-CRPB30-01	356	GZ-UDINE-1-06	317
A-TDPRO-600-05	441	EM-SBL150-01	160	GZ-CRPB30-03	356	GZ-UDINE-1-10M	317
A-TDPRO-600-10	441			GZ-CRPB30-A1	356	GZ-UDINE-1-12	317
A-TDPRO-600-90	441	G		GZ-CRPB40-01	356	GZ-UDINE-1-20M	317
A-TG-170-05	439			GZ-CRPB40-03	356	GZ-VETA-1-01	269
A-TG-170-90	439			GZ-CRPB40-A1	356	GZ-VETA-1-05	269
A-TG-235-05	439	GA-IMPER-1-02B	350	GZ-CRPC30-01	357	GZ-VETA-1-12	269
A-TG-235-90	439	GA-IMPER-1-11	350	GZ-CRPC30-A1	357	GZ-WP1136-04	346
A-TG-300-05	439	GA-IMPER-1-20M	350	GZ-CRPC40-01	357	GZ-WP1148-04	347
A-TG-300-10	439	GP-0728-J4-A-04	332	GZ-CRPC40-A1	357	GZ-WP1152-04	347
A-TG-300-20M	439	GP-0728-J4-A-07	332	GZ-FROSI-1-04	349	GZ-WP1155-01	318
A-TG-300-90	439	GP-0728-J4-B	332	GZ-FROSI-1-09	349	GZ-ZH-011-01A	320
A-TG-405-05	439	GP-0728-J4-C-04	332	GZ-GANZA-1-01	269	GZ-ZH-011-06A	320
A-TG-405-10	439	GP-0728-J4-R	332	GZ-GANZA-1-05	269		
A-TG-405-90	439	GS-BERGA-1-01	317	GZ-GANZA-1-10	269		
A-TG-600-05	439	GS-BERGA-1-02	317	GZ-GANZA-1-12	269	H	
A-TG-600-10	439	GS-BERGA-1-05	317	GZ-HILL-1-01	270	HB-USB-4X-20	258
A-TG-600-90	439	GS-BERGA-1-06	317	GZ-HILL-1-05	270	HB-USB-4X-60	258
A-TG-BUD-200-00	466	GS-BERGA-1-10	317	GZ-HILL-1-06	270		
A-TG-BUD-300-00	466	GS-BERGA-1-12	317	GZ-HILL-1-12	270		
A-TMITO-200-00	462	GS-BERGA-1-20M	317	GZ-IMOLA-1-01	280		
A-TMITO-200-00*	462	GZ-71C024-01	351	GZ-IMOLA-1-02	280	K	
A-TMITO-200-05	462	GZ-ARDEA-1-09	336	GZ-IMOLA-1-05	280	KK-D50-80-06	263
A-TMITO-250-00	462	GZ-CAD032-01	273	GZ-IMOLA-1-06	280	KK-D50100-06	263
A-TMITO-250-00*	462	GZ-CENTO-1-04	349	GZ-MILAN-32-01	288	KK-W60800-M0	264
A-TMITO-250-05	462	GZ-CENTO-1-07	349	GZ-MILAN-32-05	288	KK-W60800-M1	264
A-TMITO-300-00	462	GZ-CENTO-1-14	349	GZ-MILAN-32-06	288	KK-W80800-D0	264
A-TMITO-300-05	462	GZ-CENTO-1-20M	349	GZ-MILAN-32-20M	288	KK-W80800-D1	264
A-USZCZ-CHM4	459	GZ-CLEO-1-01	268	GZ-OLBIA-1-04	342		

KM-00-40-D20	417	KO-3002MD-CR	246	KO-SRH45100-30-10	214	KO-UMC4845C	244
KM-00-50-D20	417	KO-3002MD-SR	246	KO-SRH45100-30-OC	214	KT-APRIL-1-04	338
KM-0H-40-D20	417	KO-4002MD-CR	246	KO-SRH45100-40-10	214	KT-WP1147-04	348
KM-0H-50-D20	417	KO-4002MD-SR	246	KO-SRH45100-40-OC	214	KW-FS0125-01	152
KM-015030-10	417	KO-5002MD-CR	246	KO-SRH45100-50-10	214	KW-FS0140-01	152
KM-015030-20	417	KO-5002MD-SR	246	KO-SRH45100-50-OC	214	KW-FS0335-01	153
KM-015038-10	417	KO-6002MD-CR	246	KO-SRH45100-60-10	214	KW-FS0350-01	153
KM-015038-GM	418	KO-6002MD-SR	246	KO-SRH45100-60-OC	214	KW-FS0375-01	153
KM-A035MM-00	418	KO-CMB150-PW-01	247	KO-SRH45150-30-10	214	KW-FS0425-03	153
KM-A035MM-30	418	KO-CMB150-PW-10	247	KO-SRH45150-30-OC	214	KW-FS0430-03	153
KM-A050MM-00	419	KO-CMB150-PW-OC	247	KO-SRH45150-40-10	214	KW-FS0440-03	153
KM-A050MM-30	419	KO-CMB200-PW-01	247	KO-SRH45150-40-OC	214	KW-FS0450-03	153
KM-AH35MM-00	418	KO-CMB200-PW-10	247	KO-SRH45150-50-10	214	KW-FS0460-03	153
KM-AH35MM-30	418	KO-CMB200-PW-OC	247	KO-SRH45150-50-OC	214	KW-FS0475-03	153
KM-AH50MM-00	419	KO-CMB300-PW-01	247	KO-SRH45150-60-10	214	KW-FS0650-01	154
KM-AH50MM-30	419	KO-CMB300-PW-10	247	KO-SRH45150-60-OC	214		
KM-B050MM-00	419	KO-CMB300-PW-OC	247	KO-SRH45200-30-10	214		
KM-B050MM-30	419	KO-SRH4550-30-10	214	KO-SRH45200-30-OC	214		
KM-B075MM-00	420	KO-SRH4550-30-OC	214	KO-SRH45200-40-10	214		
KM-B075MM-30	420	KO-SRH4550-40-10	214	KO-SRH45200-40-OC	214	LB-80X160-05	260
KM-BH50MM-00	419	KO-SRH4550-40-OC	214	KO-SRH45200-50-10	214	LB-80X160-20	260
KM-BH50MM-30	419	KO-SRH4550-50-10	214	KO-SRH45200-50-OC	214	LB-80X280-05	260
KM-BH75MM-00	420	KO-SRH4550-50-OC	214	KO-SRH45200-60-10	214	LB-80X280-20	260
KM-BH75MM-30	420	KO-SRH4550-60-10	214	KO-SRH45200-60-OC	214	LB-80X500-05	261
KM-RD-35-CF	420	KO-SRH4550-60-OC	214	KO-SRPR100-30-10	215	LB-80X500-20	261
KM-RD-35-CF-20	420	KO-SRH35100-30-10	213	KO-SRPR100-30-OC	215	LB-K80X80-05	259
KM-RD-35-SF	420	KO-SRH35100-30-OC	213	KO-SRPR100-40-10	215	LB-K80X80-20	259
KM-RD-35-SF-20	420	KO-SRH35100-40-10	213	KO-SRPR100-40-OC	215	LB-K80X100-05	259
KM-RD-50-CF	421	KO-SRH35100-40-OC	213	KO-SRPR100-50-10	215	LB-K80X100-20	259
KM-RD-50-CF-20	421	KO-SRH35100-50-10	213	KO-SRPR100-50-OC	215	LD-3SKL-CBN	513
KM-RD-50-SF	421	KO-SRH35100-50-OC	213	KO-SRPR100-60-10	215	LD-3SKL-NBN	513
KM-RD-50-SF-20	421	KO-SRH35100-60-10	213	KO-SRPR100-60-OC	215	LD-3SKL-ZBN	513
KM-RD-75-CF	421	KO-SRH35100-60-OC	213	KO-SRPR150-30-10	215	LD-2835-60-60-20-CCT	471
KM-RD-75-CF-20	421	KO-SRH35150-30-10	213	KO-SRPR150-30-OC	215	LD-2835-300-20-CB	470
KM-RD-75-SF	421	KO-SRH35150-30-OC	213	KO-SRPR150-40-10	215	LD-2835-300-20-CB-50	472
KM-RD-75-SF-20	421	KO-SRH35150-40-10	213	KO-SRPR150-40-OC	215	LD-2835-300-20-CBN	470
KO-1502BO-10	245	KO-SRH35150-40-OC	213	KO-SRPR150-50-10	215	LD-2835-300-20-NE4N	470
KO-1502BO-CR	245	KO-SRH35150-50-10	213	KO-SRPR150-50-OC	215	LD-2835-300-20-NE4P	470
KO-1502BO-SR	245	KO-SRH35150-50-OC	213	KO-SRPR150-60-10	215	LD-2835-300-20-NE-50	472
KO-1502MD-CR	246	KO-SRH35150-60-10	213	KO-SRPR150-60-OC	215	LD-2835-300-20-ZB	470
KO-1502MD-SR	246	KO-SRH35150-60-OC	213	KO-SRPR200-30-10	215	LD-2835-300-20-ZB-50	472
KO-2002BO-10	245	KO-SRH35200-30-10	213	KO-SRPR200-30-OC	215	LD-2835-300-20-ZBN	470
KO-2002BO-CR	245	KO-SRH35200-30-OC	213	KO-SRPR200-40-10	215	LD-2835-300-65-CB	470
KO-2002BO-SR	245	KO-SRH35200-40-10	213	KO-SRPR200-40-OC	215	LD-2835-300-65-CBN	470
KO-2002MD-CR	246	KO-SRH35200-40-OC	213	KO-SRPR200-50-10	215	LD-2835-300-65-NE4N	470
KO-2002MD-SR	246	KO-SRH35200-50-10	213	KO-SRPR200-50-OC	215	LD-2835-300-65-ZB	470
KO-3002BO-10	245	KO-SRH35200-50-OC	213	KO-SRPR200-60-10	215	LD-2835-300-65-ZBN	470
KO-3002BO-CR	245	KO-SRH35200-60-10	213	KO-SRPR200-60-OC	215	LD-2835-600-5MM-20-CB	471
KO-3002BO-SR	245	KO-SRH35200-60-OC	213	KO-UMC4645C	244		

LD-2835-600-5MM-20-NE4	LD-CS36CB-53	497	LD-LUG319-52	503	LD-Z5CSCB-53	502
471	LD-CS36NE-53	497	LD-LUG319-53	503	LD-Z50TCB-51	501
LD-2835-600-5MM-20-ZB471	LD-CS36ZB-53	497	LD-MAX60CB-40N	508	LD-ZAC6WDE-RGB	521
LD-2835-600-20-CB	LD-DIMLED-10	533	LD-MAX60ZB-40N	508	LD-ZAS06W-30N	516
LD-2835-600-20-NE4	LD-EIW09CB-CZ	509	LD-NKW18CB-40	511	LD-ZAS12W-30N	516
LD-2835-600-20-ZB	LD-ES21CB-53N	498	LD-NKW18ZB-40	511	LD-ZAS15W-30N	516
LD-2835-600-65-CB	LD-ES21NE-53N	498	LD-NO24CB-00	510	LD-ZAS50W-30N	516
LD-2835-600-65-ZB	LD-ES21ZB-53N	498	LD-NO24ZB-00	510	LD-ZAS75W-30	516
LD-3014-1200-20-CB	LD-FL36CB-00	510	LD-OBP27CB-53	503	LD-ZAS150-NW	517
LD-3014-1200-20-NE4	LD-FL36ZB-00	510	LD-OBP27ZB-53	503	LD-ZAS350-NW	517
LD-3014-1200-20-ZB	LD-F0120CB-40	507	LD-OJVCOB-CB	496	LD-ZASPRO33W-30	516
LD-3528-300-20-CB	LD-F0120ZB-40	507	LD-OJVCOB-ZB	496	LD-ZASPU15W-30N	518
LD-3528-300-20-CB-50	LD-IRUSB-53	511	LD-OP408C-53	505	LD-ZL5RGB150-00	522
LD-3528-300-20-NE4P	LD-KABE2M-00	534	LD-OP456C-53	505	LD-ZSKL15-00	518
LD-3528-300-20-NE4P-50	LD-KJVCOB-CB	495	LD-OP609C-53	505	LD-ZTK8MM-02N	537
472	LD-KJVCOB-ZB	495	LD-OPD5W0-CB	506	LD-ZTK8MM-02N600	537
LD-3528-300-20-NE-50	LD-KLPCB-00N	513	LD-OPD9W0-CB	506	LD-ZTK10MM-02N	537
LD-3528-300-20-NI	LD-KLPNB-00N	513	LD-OPT30S-51N	501	LD-ZTKS8MM-02N	538
LD-3528-300-20-ZB	LD-KLPZB-00N	513	LD-OPT30S-53N	501	LD-ZTKT8MM-02N	536
LD-3528-300-20-ZB-50	LD-KONMINI-RGB	520	LD-OPT60S-51N	501	LD-ZTKT8MM-02N600	536
LD-3528-300-65-CB	LD-KONML-AD	526	LD-OPT60S-52N	501	LD-ZTKT10MM-02N	536
LD-3528-300-65-ZB	LD-KONML-MONO	522	LD-OPT60S-53N	501	LD-ZTKTRGB-04N	536
LD-3528-600-20-CB	LD-KONML-MONO-PAN	525	LD-PIRUSB-53	511	LD-ZTL8MM-02N	536
LD-3528-600-20-ZB	LD-KONML-MONO-PIL	524	LD-PJVCOB-CB	496	LD-ZTL8MM-02N600	536
LD-3528-600-65-CB	LD-KONML-RGBW	523	LD-PJVCOB-ZB	496	LD-ZTL8MMAMP-02N	538
LD-3528-600-65-ZB	LD-KONML-RGBW-PIL	524	LD-RA60CB-40N	507	LD-ZTL8MMAMP-02N600	538
LD-3528B-300-20-CB	LD-KONML-WRGB-PAN	525	LD-RA60ZB-40N	507	LD-ZTL10MM-02N	536
LD-3528B-300-20-ZB	LD-KONRGB-00	521	LD-RGB-150-20	471	LD-ZTL82M-2N	537
LD-3528B-300-65-CB	LD-KWP27CB-53	504	LD-RGB-150-65	471	LD-ZTL82M-2N600	537
LD-3528B-300-65-ZB	LD-KWP27ZB-53	504	LD-SR16CB-53	506	LD-ZTL102M-2N	537
LD-5050-300-20-CB	LD-LCG119-40	497	LD-SR16NE-53	506	LD-ZTLRGB2M-4N	537
LD-5050-300-20-ZB	LD-LCG119-52	497	LD-SR16ZB-53	506	LD-ZTLRGB-04N	536
LD-5050-300-65-CB	LD-LCG119-53	497	LD-TR24CB-53	500	LD-ZTL8MM-02N	538
LD-5050-300-65-ZB	LD-LCG319-40	503	LD-TR24ZB-53	500	LD-ZTL8MMAMP-02N	538
LD-5630-300-20-CB	LD-LCG319-52	503	LD-VA24CB-10	494	LD-ZTL82M-2N	538
LD-5630-300-20-ZB	LD-LCG319-53	503	LD-VA24CB-20	494	LD-ZWND6W-10	519
LD-5630-300-65-CB	LD-LU16CB-10	495	LD-VA24CB-53	494	LD-ZWND12-10	519
LD-5630-300-65-ZB	LD-LU16CB-20	495	LD-VA24NE-10	494	LD-ZZAS06KD6	519
LD-AB18CB-53	LD-LU16CB-53	495	LD-VA24NE-20	494	LD-ZZAS12KD6	519
LD-AB18ZB-53	LD-LU16NE-10	495	LD-VA24NE-53	494	LD-ZZAS15KD6	519
LD-AL24CB-53	LD-LU16NE-20	495	LD-VA24ZB-10	494	LD-ZZAS30KD6	519
LD-AL24NE-53	LD-LU16NE-53	495	LD-VA24ZB-20	494	LMB-BOCZ38L-ALU	168
LD-AL24ZB-53	LD-LU16ZB-10	495	LD-VA24ZB-53	494	LMB-BOCZ38P-ALU	168
LD-BOS1CBWB-53	LD-LU16ZB-20	495	LD-VE15CB-53	498	LMB-KAT28-ALU	168
LD-BOS1CBWG-53	LD-LU16ZB-53	495	LD-VE15CBZB-53	499	LMB-KAT38-ALU	169
LD-CHIC16NE-10	LD-LUG119-40	497	LD-VE15NE-53	498	LMB-SZCZ28-ALU	169
LD-CHIC16NE-20	LD-LUG119-52	497	LD-VE15ZB-53	498	LMB-SZCZ38-ALU	170
LD-CO20CB-53	LD-LUG119-53	497	LD-WL2457-53	504	LO-00-00-001	167
LD-CO20ZB-53	LD-LUG319-40	503	LD-Z3CSCB-53	502	LO-00-00-003	167

LO-M2M-00-125	159	MP-054350-10	87	MR-TH018-P01	184	NM-A60820-02	410
LO-P0-00-010	167	MP-054400-10	87	MR-TH019-001	185	NM-A60820-05	410
LO-P0-00-030	167	MP-054450-10	87	MR-TH019-003	185	NM-A60820-10	410
LZ-AKZ312-10N	535	MP-054450-80	87	MR-TH024-KPL	179	NM-A61100-01	410
LZ-AKZ612-10N	535	MP-054500-10	87	MR-TH035-KPL	181	NM-A61100-02	410
LZ-KAPR2M-10	534	MP-054500-80	87	MR-TH048-001	186	NM-A61100-05	410

M

MA-MATA-0-00	256	MP-086350-10	87	MR-WP-011-01	175	NM-A80710-02	411
MC-J01A-12-01	142	MP-086350-80	87	MR-WP013-001	176	NM-A80710-03	411
MC-J01A-12-06	142	MP-086400-10	87	MR-WP-14-KPL	182	NM-A80710-05	411
MC-J01A-16-01	142	MP-086400-80	87	MR-WP-15-KPL	182	NM-A80710-06	411
MC-J01A-16-06	142	MP-086450-10	87	MR-WP-028-01	171	NM-A80710-10	411
MC-J01A-19-01	142	MP-086450-80	87	MR-WP2802-01	187	NM-A80710-20	411
MC-J01A-19-06	142	MP-086500-10	87	MR-WP2804-01	188	NM-A80710-80	411
MC-J01A-25-01	142	MP-086500-80	87	MR-WP2806-01	188	NM-A80870-01	411
MC-J01A-25-06	142	MP-086550-10	87	MR-WP2807-20	189	NM-A80870-02	411
MC-J02A-25-01	143	MP-086550-80	87	MR-WP2815-01	187	NM-A80870-03	411
MC-J04A2-14-01	143	MP-118350-10	87	MR-WPS01-001	190	NM-A80870-05	411
MC-J04A2-14-06	143	MP-118400-10	87	MR-WPS03-001	190	NM-A80870-06	411
MC-J04A2-18-01	143	MP-118450-10	87	MR-WPZ002-01	173	NM-A80870-10	411
MC-J04A2-22-01	143	MP-118500-10	87	MR-WPZ003-01	174	NM-A80870-20	411
MC-J04A2-22-06	143	MP-150270-10	87	MR-WPZ006-01	186	NM-A80870-80	411
MC-J60A27-01	144	MP-150300-10	87	MR-WPZ023-01	189	NM-B103-80-01	381
MC-J60A27-06	144	MP-150350-10	87	MR-ZSL011-01	147	NM-B103-80-06	381
MC-J62-06	144	MP-150400-10	87			NM-B103-100-01	381
MC-J63-01	140	MP-150450-10	87			NM-B103-100-06	381
MC-J63-06	140	MP-150500-10	87			NM-B103-120-01	381
MC-J65-08-01	141	MP-150550-10	87			NM-B103-120-06	381
MC-J65-08-05	141	MR-R0050-001	173	NM-46R710-05	415	NM-B104-100-01	389
MC-J65-10-01	141	MR-RDRO-0000	171	NM-46R820-05	415	NM-B104-150-01	389
MC-J65-10-05	141	MR-RS025-001	172	NM-60R710-05	415	NM-B104-200-01	389
MC-J65-12-01	141	MR-RS025-10	198	NM-60R710-06	415	NM-B-140-060	383
MC-J65-12-05	141	MR-RS025-60	198	NM-60R710-20	415	NM-B-140-080	383
MC-J123-01	141	MR-T1824-KPL	179	NM-60R820-05	415	NM-B-140-100	383
MC-J123-05	141	MR-TDL011-01	147	NM-60R1100-05	415	NM-B-140-120	383
MC-K090-AR-01	145	MR-TH001-01	183	NM-60R1100-06	415	NM-B-140-150	383
MC-K091-SQ-01	145	MR-TH002-L01	183	NM-60R1100-20	415	NM-B-140-180	383
MC-K135-06-01	142	MR-TH002-P01	183	NM-380X730-01	416	NM-B-140-200	383
MG-MENSA-010	165	MR-TH004-001	178	NM-480X730-01	416	NM-BAHIA40-150-01	388
MG-MENSA-030	165	MR-TH005-001	177	NM-A60710-01	410	NM-BD-001-M1B	393
MM-FI20-KPL	161	MR-TH009-001	180	NM-A60710-02	410	NM-BD-003-01	382
MM-FI20X6X7-PL10	160	MR-TH010-001	181	NM-A60710-05	410	NM-BD-003-02	382
MM-FI20X6X7-PL20	160	MR-TH011-001	180	NM-A60710-10	410	NM-BD-003-150-01	382
MM-FI20X6X7-PL30	160	MR-TH016-001	177	NM-A60710-20	410	NM-BD-003-150-02	382
MM-FI20X6X7-PL80	160	MR-TH018-KPL	178	NM-A60710-80	410	NM-BD-100-01	385
MM-FI20X6X7-ZN	160	MR-TH018-L01	184	NM-A60820-01	410	NM-BD-100-02	385

N

NM-BD-100-05	385	NM-G61100-20	412	NM-STOMP-120-01	396	OM-OBK150-20	265
NM-BD-100-06	385	NM-KL-DPA-20	405	NM-STOMP-120-10	395	OM-OBK175-20	265
NM-BD-150-01	381	NM-KL-DPL-20	404	NM-STOMP-120-20	395	OM-OBO300-05	265
NM-BD-150-02	381	NM-MDN926-01	398	NM-STOMP-130-01	395	OM-OBO350-05	265
NM-BD-712-M1	393	NM-MDN927-01	399	NM-STOMP-130-06	395	OM-OBO400-05	265
NM-BD727-100	390	NM-MDN941-01	399	NM-STOMP-130-20	395	OM-OPW000-61	514
NM-BD-739-05	391	NM-MDN-D4-01	397	NM-STOMP-150-01	395	OM-ZH5200-53	514
NM-BD-762-01	385	NM-MLA-50-75	406	NM-STOMP-160-01	395		
NM-BD-762-05	385	NM-MLA-65-85	406	NM-STOMP-160-06	395		
NM-BD-780-M1	383	NM-MLA-85-125	407	NM-STOMP-160-20	395		
NM-BD-780-M2	383	NM-MLA-95-145	407	NM-STOPKA-M6	402		
NM-BD-780-M5	383	NM-MLA-125-195	408	NM-STOPKSZESTK-M6	403	PA-0241-35-50	330
NM-BD867-100	386	NM-MLA-KL	408	NM-STPL-135-01	396	PA-0242-35-50	328
NM-BD868-100	386	NM-MUFABW-00	403	NM-STR50-100-01	384	PA-0243-35-50	329
NM-BD868-150	386	NM-MUFABW-00	403	NM-STR50-120-01	384	PA-0244-35-50	329
NM-BD869-150	387	NM-NAC-27651-06	388	NM-STR50-150-01	384	PA-0245-35-50	330
NM-DAK27-060	391	NM-NAC-27651-10	388	NM-STR60-80-01	384	PA-GA4560-10	224
NM-DAK27-080	391	NM-NAC-27651-15	388	NM-STSL-170-60-01	400	PA-GA4560-20	224
NM-DAK27-100	391	NM-NACK27651-06	392	NM-TOKYO40-150-01	392	PA-GLAX3M-AL	478
NM-DAK27-120	391	NM-NACK27651-10	392	NM-WPJ22-D20	401	PA-GLAX-AL	478
NM-DAK27-150	391	NM-RIO-050-01	382	NM-XH3065-05	397	PA-GLAX-AL-10	478
NM-DAP77-60	387	NM-RIO-080-01	382	NM-XH8273-01	398	PA-GLAX-AL-20M	478
NM-DAP77-100	387	NM-RIO-100-01	382			PA-GLAX-AL-90	478
NM-DAP77-150	387	NM-S60710-01 (A)	413			PA-GLAXDR-AL	487
NM-DPA20-100	405	NM-S60710-01A	413	O		PA-GLAXKT3M-AL	480
NM-DPA20-100W	405	NM-S60710-02 (A)	413	OC-2PV340-01	249	PA-GLAXKT-AL	480
NM-DPA20-150	405	NM-S60710-05 (A)	413	OC-2PV340-01-18	249	PA-GLAXMIC3M-AL	477
NM-DPA20-150W	405	NM-S60710-10 (A)	413	OC-2PV340-01-18	249	PA-GLAXMIC-AL	477
NM-DPD20-100	404	NM-S60710-20 (A)	413	OC-2PV350-01	249	PA-GLAXMICNK3M-AL	473
NM-F50710-01	414	NM-S60820-01 (A)	413	OC-2PV350-01-18	249	PA-GLAXMICNK-AL	473
NM-F50710-06	414	NM-S60820-01A	413	OC-2PV360-01	249	PA-GLAXMNBWD3M19-AL	
NM-F50710-10	414	NM-S60820-02 (A)	413	OC-2PV360-01-18	249		493
NM-F50710-20	414	NM-S60820-05 (A)	413	OC-2PV370-01	249	PA-GLAXMNBW3M-AL	493
NM-F50870-01	414	NM-S60820-10 (A)	413	OC-2PV370-01-18	249	PA-GLAXMNBW3M19-AL492	
NM-F50870-06	414	NM-S60820-20 (A)	413	OC-2PV380-01	249	PA-GLAXMNBW3M-AL	492
NM-F50870-10	414	NM-SQ40ADJ-060	389	OC-2PV380-01-18	249	PA-GLAXMNBK3M-AL	474
NM-F50870-20	414	NM-SQ40ADJ-060-05	389	OC-2PV390-01	249	PA-GLAXMNBK3M-AL-10	474
NM-G60710-01	412	NM-SQ40ADJ-080	389	OC-2PV390-01-18	249	PA-GLAXMNBK3M-AL-20M474	
NM-G60710-02	412	NM-SQ40ADJ-080-05	389	OC-A0150-06	248	PA-GLAXMNBK-AL	474
NM-G60710-03	412	NM-SQ40ADJ-100	389	OC-A0160-06	248	PA-GLAXMNBK-AL-10	474
NM-G60710-05	412	NM-SQ40ADJ-100-05	389	OC-A0170-06	248	PA-GLAXMNBK-AL-20M	474
NM-G60710-06	412	NM-SQA100-01	390	OC-A0180-06	248	PA-GLAXMNBK-AL-90	474
NM-G60710-20	412	NM-SQA150-01	390	OC-A0190-06	248	PA-GLAXMNBKW-AL	476
NM-G60710-80	412	NM-STGC50-95-01	394	OC-A0350K-06	250	PA-GLAXMNBKW-AL-10	476
NM-G60820-01	412	NM-STGY135-100-01	394	OC-A0450-06	250	PA-GLAXMNBKW-AL-20M	476
NM-G60820-05	412	NM-STGY135-120-01	395	OC-A0460D-06	251	PA-GLAXMNBKW-AL-90	476
NM-G60820-06	412	NM-STGY135-130-01	394	OC-A0660-06	248	PA-GLAXMPK-AL	486
NM-G60820-20	412	NM-STGY135-150-01	394	OC-A0680-06	248	PA-GLAXMW-AL	479
NM-G61100-01	412	NM-STOMP-100-01	395	OC-E0707D-CZ	251	PA-GLAXMW-AL-10	479

P

O

PA-GLAXMW-AL-20M	479	PA-OSMLGLAXMIC-00		PA-ZASGLAXNKKT-90	482	PB-90954100PCT	239
PA-GLAXMW-AL-90	479		473, 477	PA-ZASGLAXNKKT-00	482	PB-91014100	236
PA-GLAXNBD2M16-AL	490	PA-OSMLGLAXMIC3M-00	473	PA-ZASGLAXRAD-00	483	PB-91024160V	236
PA-GLAXNBD2M19-AL	490	PA-OSMLGLAXMK-00474,	479	PA-ZAWGLAXADR-00	483, 487	PB-91104100B5	242
PA-GLAXNBD3M16-AL	490	PA-OSMLGLAXMO-00	474	PB-0FPO-250	66	PB-91114100B5	242
PA-GLAXNBD3M19-AL	490	PA-OSMLGLAXSO-00	483	PB-0FPO-270	66	PB-91164100B5	242
PA-GLAXNBD3M-AL	490	PA-OSMLGLAXT-00	482	PB-0FPO-300	66	PB-91174100B5	242
PA-GLAXNBDW2M16-AL	491	PA-OSTRGLAX-00		PB-0FPO-350	66	PB-91464100PCT	240
PA-GLAXNBDW2M19-AL	491		478, 480, 481, 482,	PB-0FPO-400	66	PB-91474100PCT	240
PA-GLAXNBDW3M16-AL	491		483, 484, 485, 487,	PB-0FPO-450	66	PB-91554160V	241
PA-GLAXNBDW3M19-AL	491		488, 489, 490	PB-0FPO-500	66	PB-91564160V	241
PA-GLAXNBDW3M-AL	491	PA-OSTRGLAX3M-00		PB-0FPO-550	66	PB-91634100B5V	242
PA-GLAXNB2M16-AL	488		478, 480, 482, 488,	PB-0FPO-600	66	PB-91644100B5V	242
PA-GLAXNB2M19-AL	488		489, 490, 491	PB-0M2S15-60MB	231	PB-AXIS-KPL300A	122
PA-GLAXNB3M16-AL	488	PA-OSTRGLAXM-00		PB-0M2S20-60MB	233	PB-AXIS-KPL300A1	122
PA-GLAXNB3M19-AL	488		474, 475, 476, 479,	PB-0M2X34-60MB	235	PB-AXIS-KPL300B	122
PA-GLAXNB3M-AL	488		486	PB-0SHX18-300-H	61	PB-AXIS-KPL300B1	122
PA-GLAXNB3M16-AL	489	PA-OSTRGLAXM3M-00		PB-0SHX18-350-H	61	PB-AXIS-KPL300C	123
PA-GLAXNB3M19-AL	489		474, 475, 492, 493	PB-0SHX18-400-H	61	PB-AXIS-KPL300C1	123
PA-GLAXNB3M-AL	489	PA-ROZGLAX-53	487	PB-0SHX18-450-H	61	PB-AXIS-KPL350A	122
PA-GLAXNB3M16-AL	489	PA-SPRGLAXM-00		PB-0SHX18-500-H	61	PB-AXIS-KPL350A1	122
PA-GLAXNB3M19-AL	489		474, 476, 483	PB-0SHX18-550-H	61	PB-AXIS-KPL350B	122
PA-GLAXNB3M-AL	489	PA-USZGLAX-00N	485	PB-0SHX-250-A	60	PB-AXIS-KPL350B1	122
PA-GLAXNK3M-AL	475	PA-ZASGLAX-00	478	PB-0SHX-270-A	60	PB-AXIS-KPL350C	123
PA-GLAXNK-AL	475	PA-ZASGLAX-10	478	PB-0SHX-300-A	60	PB-AXIS-KPL350C1	123
PA-GLAXNKKT3M-AL	482	PA-ZASGLAX-20M	478	PB-0SHX-350-A	60	PB-AXIS-KPL400A	122
PA-GLAXNKKT-AL	482	PA-ZASGLAX-90	478	PB-0SHX-400-A	60	PB-AXIS-KPL400A1	122
PA-GLAXNKKT-AL-10	482	PA-ZASGLAXDR-00	487	PB-0SHX-450-A	60	PB-AXIS-KPL400B	122
PA-GLAXNKKT-AL-20M	482	PA-ZASGLAXKT-00	480	PB-0SHX-500-A	60	PB-AXIS-KPL400B1	122
PA-GLAXNKKT-AL-90	482	PA-ZASGLAXMIC-00	477	PB-0SHX-550-A	60	PB-AXIS-KPL400C	123
PA-GLAXRAD-AL	483	PA-ZASGLAXMICNK-00	473	PB-0SHX-600-A	60	PB-AXIS-KPL400C1	123
PA-GLAXREG1-AL	484	PA-ZASGLAXMNC-00	474	PB-002X15-60MB	230	PB-AXIS-KPL450A	122
PA-GLAXREG2-AL	484	PA-ZASGLAXMNC-20M	474	PB-002X20-60MB	232	PB-AXIS-KPL450A1	122
PA-GLAXWN16-AL	485	PA-ZASGLAXMNC-90	474	PB-3D0SHX18-300-H	62	PB-AXIS-KPL450B	122
PA-GLAXWN19-AL	485	PA-ZASGLAXMNC-00	474	PB-3D0SHX18-350-H	62	PB-AXIS-KPL450B1	122
PA-GLAXWN-AL	485	PA-ZASGLAXMNC-00	474	PB-3D0SHX18-400-H	62	PB-AXIS-KPL450C	123
PA-GLAXWPKT-AL	481	PA-ZASGLAXMNC-00	476	PB-3D0SHX18-450-H	62	PB-AXIS-KPL450C1	123
PA-OSMLGLAX-00		PA-ZASGLAXMNC-10	476	PB-3D0SHX18-500-H	62	PB-AXIS-KPL500A	122
	478, 480, 481, 482,	PA-ZASGLAXMNC-20M	476	PB-3D0SHX18-550-H	62	PB-AXIS-KPL500A1	122
	483, 484, 485, 487,	PA-ZASGLAXMNC-90	476	PB-45-002X20	228	PB-AXIS-KPL500B	122
	488, 489, 490	PA-ZASGLAXMW-00	479	PB-45-0010X3	227	PB-AXIS-KPL500B1	122
PA-OSMLGLAX3M-00		PA-ZASGLAXMW-10	479	PB-45-202X10	228	PB-AXIS-KPL500C	123
	478, 480, 482, 488,	PA-ZASGLAXMW-20M	479	PB-45-002010	227	PB-AXIS-KPL500C1	123
	489, 490, 491	PA-ZASGLAXMW-90	479	PB-45M002S20	229	PB-AXIS-KPL550A	122
PA-OSMLGLAXM-00		PA-ZASGLAXMWK-00	479	PB-45M202S10	229	PB-AXIS-KPL550A1	122
	474, 475, 476, 479,	PA-ZASGLAXNK-00	475	PB-0202X1060MB	232	PB-AXIS-KPL550B	122
	486	PA-ZASGLAXNKKT-00	482	PB-90114100	237	PB-AXIS-KPL550B1	122
PA-OSMLGLAXM3M-00		PA-ZASGLAXNKKT-10	482	PB-90144100PCT	238	PB-AXIS-KPL550C	123
	474, 475, 492, 493	PA-ZASGLAXNKKT-20M	482	PB-90934100PCT	239	PB-AXIS-KPL550C1	123

PB-AXIS-PANELWEW	126	PB-D-KPL68-500-80	118	PB-D-P20300A	104	PB-D-W2R0-01	101, 116
PB-AXIS-PANELWEW-10	126	PB-D-KPL250A	104	PB-D-P20300C	105	PB-D-WEWMOCA	106
PB-AXIS-RELKW300	124	PB-D-KPL250A1	104	PB-D-P20350A	104	PB-D-WEWMOCA1	106
PB-AXIS-RELKW300-10	124	PB-D-KPL250C	105	PB-D-P20350C	105	PB-D-WEWMOCA-KW	95
PB-AXIS-RELKW350	124	PB-D-KPL250C1	105	PB-D-P20400A	104	PB-D-WEWMOCA-KW-10	95
PB-AXIS-RELKW350-10	124	PB-D-KPL300A	104	PB-D-P20400C	105	PB-D-WEWMOCB	107
PB-AXIS-RELKW400	124	PB-D-KPL300A1	104	PB-D-P20450A	104	PB-D-WEWMOCB1	107
PB-AXIS-RELKW400-10	124	PB-D-KPL300B	105	PB-D-P20450C	105	PB-D-WEWMOCB-KW	95
PB-AXIS-RELKW450	124	PB-D-KPL300C	105	PB-D-P20500A	104	PB-D-WEWMOCB-KW-10	95
PB-AXIS-RELKW450-10	124	PB-D-KPL300C1	105	PB-D-P20500C	105	PB-D-WEWMOCC	108
PB-AXIS-RELKW500	124	PB-D-KPL350A	104	PB-D-P20550A	104	PB-D-WEWMOCC1	108
PB-AXIS-RELKW500-10	124	PB-D-KPL350A1	104	PB-D-P20550C	105	PB-D-WEWMOCC-KW	96
PB-AXIS-RELKW550	124	PB-D-KPL350B	105	PB-D-P20STAB	91	PB-D-WEWMOCC-KW-10	96
PB-AXIS-RELKW550-10	124	PB-D-KPL350C	105	PB-D-PANELWEW	96, 108	PB-D-WEWSZKLC	107
PB-AXIS-RP-1100	126	PB-D-KPL350C1	105	PB-D-PANELWEW-10	96, 108	PB-D-WEWSZKLC-10	107
PB-AXIS-RP-1100-10	126	PB-D-KPL400A	104	PB-D-PRZEGLP	113	PB-D-ZLE-450	120
PB-AXIS-U2R0-00	123	PB-D-KPL400A1	104	PB-D-PRZEGLP-10	113	PB-D-ZLE-500	120
PB-AXIS-U2R0-10	123	PB-D-KPL400B	105	PB-D-PRZEGLP-KW	99	PB-D-ZNACZ-0	102, 117
PB-AXIS-WEWMOCA	124	PB-D-KPL400C	105	PB-D-PRZEGLP-KW-10	99	PB-D-ZR-00-0	109
PB-AXIS-WEWMOCA1	124	PB-D-KPL400C1	105	PB-D-REL450-10	106	PB-D-ZR-00-10	109
PB-AXIS-WEWMOCB	125	PB-D-KPL450A	104	PB-D-REL500-10	106	PB-D-ZR-KW-00	97
PB-AXIS-WEWMOCB1	125	PB-D-KPL450A1	104	PB-D-REL550-10	106	PB-D-ZR-KW-10	97
PB-AXIS-WEWMOCC	125	PB-D-KPL450B	105	PB-D-REL2500	106	PB-G10HX-250	68
PB-AXIS-WEWMOCC1	125	PB-D-KPL450C	105	PB-D-REL3000	106	PB-G10HX-300	68
PB-D-BXSIDE45B	113	PB-D-KPL450C1	105	PB-D-REL3500	106	PB-G10HX-350	68
PB-D-BXSIDE45B-10	113	PB-D-KPL500A	104	PB-D-REL4000	106	PB-G10HX-400	68
PB-D-BXSIDE45C	114	PB-D-KPL500A1	104	PB-D-REL4500	106	PB-G10HX-450	68
PB-D-BXSIDE45C-10	114	PB-D-KPL500B	105	PB-D-REL5000	106	PB-G10HX-500	68
PB-D-BXSIDE50B	113	PB-D-KPL500C	105	PB-D-REL5500	106	PB-G10HX-550	68
PB-D-BXSIDE50B-10	113	PB-D-KPL500C1	105	PB-D-RELCOV	111	PB-G10HX-600	68
PB-D-BXSIDE50C	114	PB-D-KPL550A	104	PB-D-RELCOV-10	111	PB-GAPO-250	65
PB-D-BXSIDE50C-10	114	PB-D-KPL550A1	104	PB-D-RELKW350	94	PB-GAPO-270	65
PB-D-CONBXSID	112	PB-D-KPL550B	105	PB-D-RELKW350-10	94	PB-GAPO-300	65
PB-D-CONBXSIDE-10	112	PB-D-KPL550C	105	PB-D-RELKW400	94	PB-GAPO-350	65
PB-D-CONREL	112	PB-D-KPL550C1	105	PB-D-RELKW400-10	94	PB-GAPO-400	65
PB-D-CONREL-10	112	PB-D-LIS1100	111	PB-D-RELKW450	94	PB-GAPO-450	65
PB-D-CONREL-KW	98	PB-D-LIS1100-10	111	PB-D-RELKW450-10	94	PB-GAPO-500	65
PB-D-CONREL-KW-10	98	PB-D-LIS1100-KW	98	PB-D-RELKW500	94	PB-GAPO-550	65
PB-D-COR600A	119	PB-D-LIS1100-KW-10	98	PB-D-RELKW500-10	94	PB-GAPO-600	65
PB-D-COR600C	119	PB-D-LR-00-0	110	PB-D-RELKW550	94	PB-GCHX-250	63
PB-D-COR650A	119	PB-D-LR-00-10	110	PB-D-RELKW550-10	94	PB-GCHX-270	63
PB-D-COR650C	119	PB-D-MATRYCA	102, 117	PB-D-RP-1100	109	PB-GCHX-300	63
PB-D-D2R0-00	99, 116	PB-D-MBSTAB-00	118	PB-D-RP-1100-10	109	PB-GCHX-300-H	64
PB-D-D2R0-01	99, 116	PB-D-MHG04	117	PB-D-S2R0-00	100, 115	PB-GCHX-350	63
PB-D-DBOX450C	114	PB-D-MHG04-KW	101	PB-D-S2R0-01	100, 115	PB-GCHX-350-H	64
PB-D-DBOX500C	114	PB-D-N2R0-00	100, 115	PB-D-UCHWEW	110	PB-GCHX-400	63
PB-D-KPL68-450-10	118	PB-D-N2R0-01	100, 115	PB-D-UCHWEW-10	110	PB-GCHX-400-H	64
PB-D-KPL68-450-80	118	PB-D-P20250A	104	PB-D-ULE-500	120	PB-GCHX-450	63
PB-D-KPL68-500-10	118	PB-D-P20250C	105	PB-D-W2R0-00	101, 116	PB-GCHX-450-H	64

PB-GCHX-500	63	PB-KW-KPL500A1	93	PB-LINOS-PANELWEW-10		PD-G60160-N02	54
PB-GCHX-500-H	64	PB-KW-KPL500A2	93		131	PD-G80160-N02	54
PB-GCHX-550	63	PB-KW-KPL500B	93	PB-LINOS-RP-1200	131	PD-GAM050-N02	49
PB-GCHX-550-H	64	PB-KW-KPL500B1	93	PB-LINOS-RP-1200-10	131	PD-GAM050-N10	49
PB-GCHX-600	63	PB-KW-KPL500B2	93	PB-LINOS-WEWMOCA	130	PD-GAM050-N60	49
PB-KW-KPL250A1	93	PB-KW-KPL500C	94	PB-LINOS-WEWMOCA1	130	PD-GAM060-N02	49
PB-KW-KPL250A2	93	PB-KW-KPL500C1	94	PB-LINOS-WEWMOCC	130	PD-GAM060-N10	49
PB-KW-KPL250B	93	PB-KW-KPL500C2	94	PB-LINOS-WEWMOCC1	130	PD-GAM060-N60	49
PB-KW-KPL250B1	93	PB-KW-KPL550A	93	PB-LINOS-WEWMOCCD	130	PD-GAM080-N02	49
PB-KW-KPL250B2	93	PB-KW-KPL550A1	93	PB-LINOS-WEWMOCCD1	130	PD-GAM080-N10	49
PB-KW-KPL250C	94	PB-KW-KPL550A2	93	PB-M202X1060MB	233	PD-GAM080-N60	49
PB-KW-KPL250C1	94	PB-KW-KPL550B	93	PB-M342X1760MB	235	PD-GAM100-N02	49
PB-KW-KPL250C2	94	PB-KW-KPL550B1	93	PB-Q10HX250-H	69	PD-GAM100-N10	49
PB-KW-KPL300A	93	PB-KW-KPL550B2	93	PB-Q10HX300-H	69	PD-GAM100-N60	49
PB-KW-KPL300A1	93	PB-KW-KPL550C	94	PB-Q10HX350-H	69	PD-GAM120-N02	49
PB-KW-KPL300A2	93	PB-KW-KPL550C1	94	PB-Q10HX400-H	69	PD-GAM120-N10	49
PB-KW-KPL300B1	93	PB-KW-KPL550C2	94	PB-Q10HX450-H	69	PD-GAM120-N60	49
PB-KW-KPL300B2	93	PB-LINOS-KPL300A	128	PB-RP-KW1100	97	PD-GAM150-N02	49
PB-KW-KPL300C	94	PB-LINOS-KPL300A1	128	PB-RP-KW1100-10	97	PD-GAM150-N10	49
PB-KW-KPL300C1	94	PB-LINOS-KPL350A	128	PB-S10C300HX	67	PD-GAM150-N60	49
PB-KW-KPL300C2	94	PB-LINOS-KPL350A1	128	PB-S10C350HX	67	PD-GAMB050-N02	50
PB-KW-KPL350A	93	PB-LINOS-KPL350B	128	PB-S10C400HX	67	PD-GAMB050-N10	50
PB-KW-KPL350A1	93	PB-LINOS-KPL350B1	128	PB-S10C450HX	67	PD-GAMB050-N60	50
PB-KW-KPL350A2	93	PB-LINOS-KPL350C	129	PB-S400MF-2X16-60	226	PD-GAMB060-N02	50
PB-KW-KPL350B	93	PB-LINOS-KPL350C1	129	PB-S600MF-2X27-60	234	PD-GAMB060-N10	50
PB-KW-KPL350B1	93	PB-LINOS-KPL400A	128	PD-ECGDL-060	59	PD-GAMB060-N60	50
PB-KW-KPL350B2	93	PB-LINOS-KPL400A1	128	PD-ECGDL-080	59	PD-GAMB080-N02	50
PB-KW-KPL350C	94	PB-LINOS-KPL400B	128	PD-ECGDL-150	59	PD-GAMB080-N10	50
PB-KW-KPL350C1	94	PB-LINOS-KPL400B1	128	PD-G0050-N02	52	PD-GAMB080-N60	50
PB-KW-KPL350C2	94	PB-LINOS-KPL400C	129	PD-G0050-N10	53	PD-GAMB100-N02	50
PB-KW-KPL400A	93	PB-LINOS-KPL400C1	129	PD-G0050-N20	53	PD-GAMB100-N10	50
PB-KW-KPL400A1	93	PB-LINOS-KPL450A	128	PD-G0050-N60	53	PD-GAMB100-N60	50
PB-KW-KPL400A2	93	PB-LINOS-KPL450A1	128	PD-G0060-N02	52	PD-GAMB120-N02	50
PB-KW-KPL400B	93	PB-LINOS-KPL450B	128	PD-G0060-N10	53	PD-GAMB120-N10	50
PB-KW-KPL400B1	93	PB-LINOS-KPL450B1	128	PD-G0060-N20	53	PD-GAMB120-N60	50
PB-KW-KPL400B2	93	PB-LINOS-KPL450C	129	PD-G0060-N60	53	PD-GAMB150-N02	50
PB-KW-KPL400C	94	PB-LINOS-KPL450C1	129	PD-G0080-N02	52	PD-GAMB150-N10	50
PB-KW-KPL400C1	94	PB-LINOS-KPL450D	129	PD-G0080-N10	53	PD-GAMB150-N60	50
PB-KW-KPL400C2	94	PB-LINOS-KPL450D1	129	PD-G0080-N20	53	PD-GPD01-001	55
PB-KW-KPL450A	93	PB-LINOS-KPL500A	128	PD-G0080-N60	53	PD-GPD02-002	55
PB-KW-KPL450A1	93	PB-LINOS-KPL500A1	128	PD-G0100-N02	52	PD-GPD03-005	55
PB-KW-KPL450A2	93	PB-LINOS-KPL500B	128	PD-G0100-N10	53	PD-LIFT-HEAVY_DUTY-10	48
PB-KW-KPL450B	93	PB-LINOS-KPL500B1	128	PD-G0100-N20	53	PD-LIFT-HEAVY_DUTY-80	48
PB-KW-KPL450B1	93	PB-LINOS-KPL500C	129	PD-G0100-N60	53	PD-LIFT-LIGHT-10	48
PB-KW-KPL450B2	93	PB-LINOS-KPL500C1	129	PD-G0120-N02	52	PD-LIFT-LIGHT-80	48
PB-KW-KPL450C	94	PB-LINOS-KPL500D	129	PD-G0120-N10	53	PD-LIFT-MEDIUM-10	48
PB-KW-KPL450C1	94	PB-LINOS-KPL500D1	129	PD-G0120-N20	53	PD-LIFT-MEDIUM-80	48
PB-KW-KPL450C2	94	PB-LINOS-KPL500D1	129	PD-G0120-N60	53	PD-LIFT-STRONG-10	48
PB-KW-KPL500A	93	PB-LINOS-PANELWEW	131	PD-G0150-N02	52	PD-LIFT-STRONG-80	48

PD-MDLIFT-P1-D	57	PK-0-H53-350	70	PK-L-H45-450-A	73	PM-NAR1003-725	155
PD-MDLIFT-P2-D	58	PK-0-H53-400	70	PK-L-H45-450-GX	74	PM-NAR1003-728	155
PD-MD-ZB-01-KPL	41	PK-0-H53-450	70	PK-L-H45-500	72	PM-NAR1003-731	155
PD-MD-ZB-04-KPL	41	PK-0-H53-500	70	PK-L-H45-500-A	73	PM-NAR1003-732	155
PD-PD000-001	56	PK-0-H53-550	70	PK-L-H45-500-GX	74	PM-NAR1003-770	155
PG-AL4560-20	225	PK-0-H53-600	70	PK-L-H45-550	72	PM-NAR1003-771	155
PG-AL6083-20	225	PK-0-H53-650	70	PK-L-H45-550-A	73	PM-NAR1004-512	156
PG-AL8311520	225	PK-0-H53-700	70	PK-L-H45-550-GX	74	PM-NAR1004-645	156
PG-GA6083-10	224	PK-0-H53-750	70	PK-L-H45-600	72	PM-NAR1004-677	156
PG-GA6083-20	224	PK-0-H53-800	70	PK-L-H45-600-A	73	PM-NAR1004-680	156
PG-GA8311520	224	PK-0-H53-900	70	PK-L-H45-600-GX	74	PM-NAR1004-695	156
PG-ST4560-10	225	PK-0-H53-1000	70	PK-P-0H45-300A	76	PM-NAR1004-724	156
PG-ST4560-10A	200	PK-0-H53-1100	70	PK-P-0H45-350A	76	PM-NAR1004-725	156
PG-ST4560-20	225	PK-0H17182XP	85	PK-P-0H45-400A	76	PM-NAR1004-728	156
PG-ST4560-60	200	PK-0H17214XP	85	PK-P-0H45-450A	76	PM-NAR1004-731	156
PG-ST6083-10	225	PK-0H17246XP	85	PK-P-0H45-500A	76	PM-NAR1004-732	156
PG-ST6083-10A	200	PK-0H17278XP	85	PK-P-0H45-550A	76	PM-NAR1004-770	156
PG-ST6083-20	225	PK-0H17310XP	85	PK-P-0H45-600A	76	PM-NAR1004-771	156
PG-ST6083-60	200	PK-0H17342XP	85	PK-P-0H45-700A	76	PM-PFMH50-24	166
PG-ST83115-10	225	PK-0H17406XP	85	PK-P-H45-300-GX	77	PM-PFMH50-25	166
PG-ST83115-10A	200	PK-0H17438XP	85	PK-P-H45-350-GX	77	PM-PFMH51-10	166
PG-ST83115-60	200	PK-0H45250GX1	79	PK-P-H45-400-GX	77	PM-PFMH53-10	166
PG-ST8311520	225	PK-0H45300GX1	79	PK-P-H45-450-GX	77	PM-PFMH55-25	166
PK-0-000-027	84	PK-0H45350GX1	79	PK-P-H45-500-GX	77	PM-PFMH61-10	166
PK-0H27-3000	83	PK-0H45400GX1	79	PK-P-H45-550-GX	77	PM-PFMH64-10	166
PK-0H27-3500	83	PK-0H45450GX1	79	PK-P-H45-600-GX	77	PM-PFMH64-25	166
PK-0H27-4000	83	PK-0H45500GX1	79	PK-S-H45-250	75	PM-PFMH69-10	166
PK-0H27-4500	83	PK-0H45550GX1	79	PK-S-H45-300	75	PM-PLFI60-02	262
PK-0H27-5000	83	PK-0H45600GX1	79	PK-S-H45-350	75	PM-PLFI60-05	262
PK-0H30-2500	82	PK-0H45650GX1	79	PK-S-H45-400	75	PM-PLFI60-10	262
PK-0H30-3000	82	PK-0H45700GX1	79	PK-S-H45-450	75	PM-PLFI60-20	262
PK-0H30-3500	82	PK-L-H35-300	80	PK-S-H45-500	75	PM-PLFI60-30	262
PK-0H30-4000	82	PK-L-H35-350	80	PK-S-H45-550	75	PM-PLFI60-41	262
PK-0H35-2500	81	PK-L-H35-400	80	PK-S-H45-600	75	PM-PLFI60-42	262
PK-0H35-3000	81	PK-L-H35-450	80	PK-S-H45-650	75	PM-PLFI60-43	262
PK-0H35-3500	81	PK-L-H35-500	80	PK-S-H45-700	75	PM-PLFI60-44	262
PK-0H35-4000	81	PK-L-H35-550	80	PM-LBFI60-01	261	PM-PLFI60-45	262
PK-0H35-4500	81	PK-L-H45-250	72	PM-LBFI60-02	261	PM-PLFI60-46	262
PK-0H35-5000	81	PK-L-H45-250-A	73	PM-LBFI60-05	261	PM-PLFI60-47	262
PK-0-H45-250	78	PK-L-H45-300	72	PM-LBFI60-06	261	PM-PLFI60-48	262
PK-0-H45-300	78	PK-L-H45-300-A	73	PM-LBFI80-01	261	PM-PLFI60-49	262
PK-0-H45-350	78	PK-L-H45-300-GX	74	PM-LBFI80-02	261	PM-PLFI60-50	262
PK-0-H45-400	78	PK-L-H45-350	72	PM-LBFI80-05	261	PM-PLFI60-51	262
PK-0-H45-450	78	PK-L-H45-350-A	73	PM-LBFI80-06	261	PM-PLFI60-52	262
PK-0-H45-500	78	PK-L-H45-350-GX	74	PM-NAR1003-512	155	PM-PLFI60-58	262
PK-0-H45-550	78	PK-L-H45-400	72	PM-NAR1003-645	155	PP-00GS01-01	134
PK-0-H45-600	78	PK-L-H45-400-A	73	PM-NAR1003-677	155	PP-00GS01-02	134
PK-0-H45-700	78	PK-L-H45-400-GX	74	PM-NAR1003-680	155	PP-00GS01-05	134
PK-0-H53-300	70	PK-L-H45-450	72	PM-NAR1003-695	155	PP-00GS02-01	134

PP-00GS02-02	134	PP-OBUW80-05	210	PR-SP-300-10	88	RS-272192-06	323
PP-00GS02-05	134	PP-OBUW80-PW	210	PR-SP-350-10	88	RS-272192-14	323
PP-00GS02-06	134	PP-OBUW90-05	210	PR-SP-400-10	88	RS-304224-01	323
PP-00GS03-01	135	PP-OBUW90-PW	210	PR-SP-450-10	88	RS-304224-02	323
PP-00GS03-02	135	PP-P04570-20	223	PR-SP-500-10	88	RS-304224-05	323
PP-00GS03-05	135	PP-P80110-20	223	PR-SP-550-10	88	RS-304224-06	323
PP-00GS03-06	135	PP-PMONT0D-01	155	PR-SP-600-10	88	RS-304224-14	323
PP-00GS04-01	135	PP-PMONT0D-07	155	PU-KEY027-20	257	RS-336256-01	323
PP-00GS04-02	135	PP-PMONT0D-08	155	PU-KEY027-60	257	RS-336256-02	323
PP-00GS04-05	135	PP-PMONT0D-11	155	PU-KEYM27-20	257	RS-336256-05	323
PP-00GS04-06	135	PP-PMONT0D-20	155	PU-KEYM27-60	257	RS-336256-06	323
PP-20BUW0-05	209	PP-PMONT0D-22	155	PU-PKO-00-20	258	RS-336256-14	323
PP-DP0105-01	133	PP-PMONT0D-41	155	PU-PKO-00-60	258	RS-368288-01	323
PP-DP0105-02	133	PP-PMONT0D-50	155	PW-PC31209-00N	494	RS-368288-02	323
PP-DP0105-05	133	PP-PMONT0D-724	155	PW-PC61209-00	494	RS-368288-05	323
PP-DP0105-06	133	PP-PMONT0D-732	155			RS-368288-06	323
PP-FI20-16-KPL	161	PP-PMONT0M-01	154			RS-400320-01	323
PP-FI20-18-KPL	161	PP-PMONT0M-07	154	R		RS-400320-02	323
PP-GL-A48-01	136	PP-PMONT0M-08	154			RS-400320-05	323
PP-GL-B48-01	136	PP-PMONT0M-11	154	RR-161030H01	172	RS-400320-06	323
PP-GL-CGP-01	137	PP-PMONT0M-20	154	RR-161230H01	172	RS-400320-14	323
PP-GL-DR5-01	146	PP-PMONT0M-22	154	RR-250730H01	172	RS-432352-01	323
PP-GL-DR5-15	146	PP-S0L003-01	138	RR-250830H01	172	RS-432352-02	323
PP-GL-DR6-01	146	PP-S0L012-01	139	RR-250930H01	172	RS-432352-05	323
PP-GL-DR6-15	146	PP-SMART-000	148	RR-250930H10	198	RS-432352-06	323
PP-GL-E410-01	137	PP-SP0075-01	133	RR-250930H60	198	RS-464384-01	323
PP-GL-F46B-01	138	PP-SP0075-02	133	RR-251030H01	172	RS-464384-02	323
PP-HS0006-01	139	PP-SP0075-05	133	RR-401230H01	172	RS-464384-05	323
PP-HS2710-01	140	PP-SP0075-06	133	RR-501030H01	172	RS-464384-06	323
PP-LUK-00-01	149	PP-SPL001-01	147	RR-501230H01	172	RS-496416-01	323
PP-LUK-00-02	149	PP-XS0045-01	132	RR-CH-OW-000	170	RS-496416-02	323
PP-LUK-00-05	149	PP-XS0045-05	132	RS-156096-01	323	RS-496416-05	323
PP-MP0055-01	132	PR-0B-250-10	89	RS-156096-02	323	RS-496416-06	323
PP-MP0055-02	132	PR-0B-250-30	89	RS-156096-05	323	RS-528448-01	323
PP-MP0055-05	132	PR-0B-300-10	89	RS-156096-06	323	RS-528448-02	323
PP-MP0055-06	132	PR-0B-300-30	89	RS-156096-14	323	RS-528448-05	323
PP-MP0055-10	132	PR-0B-350-10	89	RS-188128-01	323	RS-528448-06	323
PP-MP0055-20	132	PR-0B-350-30	89	RS-188128-02	323	RS-560480-01	323
PP-NW09X90B	148	PR-0B-400-10	89	RS-188128-05	323	RS-560480-02	323
PP-NW10X100B	148	PR-0B-400-30	89	RS-188128-06	323	RS-560480-05	323
PP-NW10X145B	148	PR-0B-450-10	89	RS-188128-14	323	RS-560480-06	323
PP-NW12X120B	148	PR-0B-450-30	89	RS-220160-01	323	RS-592512-01	323
PP-NW14X120B	148	PR-0B-500-10	89	RS-220160-02	323	RS-592512-02	323
PP-NW14X140B	148	PR-0B-500-30	89	RS-220160-05	323	RS-592512-05	323
PP-NW14X165B	148	PR-0B-550-10	89	RS-220160-06	323	RS-592512-06	323
PP-OBUW60-05	210	PR-0B-550-30	89	RS-220160-14	323	RS-624544-01	323
PP-OBUW60-PW	210	PR-0B-600-10	89	RS-272192-01	323	RS-624544-02	323
PP-OBUW70-05	210	PR-0B-600-30	89	RS-272192-02	323	RS-624544-05	323
PP-OBUW70-PW	210	PR-SP-250-10	88	RS-272192-05	323	RS-624544-06	323

RS-SZ-400-10	90	UA-00-337192-20M	307	UA-A18224-01	298	UA-B0-311256-20M	296
RS-SZ-450-10	90	UA-00-337224	307	UA-A18224-06MJ	298	UA-B0-311288	296
RS-SZ-450-80	90	UA-00-337224-20M	307	UA-A18256-01	298	UA-B0-311320	296
RS-SZ-500-10	90	UA-00-337256	307	UA-A18256-06MJ	298	UA-B0-311320-20M	296
RS-SZ-500-80	90	UA-00-337256-20M	307	UA-A18320-01	298	UA-B0-311480	296
RS-TRIES-96-06	322	UA-00-337320	307	UA-A18320-06MJ	298	UA-B0-337128	297
RS-TRIES-128-06	322	UA-00-337320-20M	307	UA-A18400-01	298	UA-B0-337160	297
RS-TRIES-160-06	322	UA-00-338128	307	UA-A18400-06MJ	298	UA-B0-337192	297
RS-TRIES-192-06	322	UA-00-338160	307	UA-A18416-01	298	UA-B0-337224	297
RS-TRIES-256-06	322	UA-00-340128	308	UA-A18416-06MJ	298	UA-B0-337256	297
RS-TRIES-320-06	322	UA-00-340160	308	UA-A18480-01	298	UA-B0-337320	297

S

SB-A60X72-80	416	UA-00-340256	308	UA-A18480-06MJ	298	UA-B31109606MJ	296
SZ-005-00-01	163	UA-00-340224	308	UA-AA-04-128	296	UA-B31112801	296
SZ-005-00-01-A	163	UA-00-340256	308	UA-AA-04-160	296	UA-B31112806MJ	296
SZ-008-00-01	163	UA-00-340320	308	UA-AA-04-192	296	UA-B31116001	296
SZ-008-00-01-A	163	UA-00-347128	308	UA-AA-04-224	296	UA-B31116006MJ	296
		UA-00-347160	308	UA-AA-04-256	296	UA-B31119201	296
		UA-00-347192	308	UA-AA-04-288	296	UA-B31119206MJ	296
		UA-00-347224	308	UA-AA-04-320	296	UA-B31122401	296
		UA-00-347256	308	UA-AA-114-02	297	UA-B31122406MJ	296
		UA-00-347320	308	UA-AA-114-05	297	UA-B31125601	296

T

TE-150000-30	520	UA-01-326096-V1	324	UA-ALFA-32-05	303	UA-B31125606MJ	296
TE-200000-30	520	UA-01-326128-V1	324	UA-ALFA-96-05	303	UA-B31128806MJ	296
TE-600000-30	520	UA-01-326160	324	UA-ALFA-128-05	303	UA-B31132001	296
		UA-18-128146	298	UA-ALFA-160-05	303	UA-B31132006MJ	296
		UA-18-160178	298	UA-ALFA-192-05	303	UA-B31148006MJ	296
		UA-18-192210	298	UA-ALFA-224-05	303	UA-B33712801	297

U

		UA-18-224242	298	UA-ALFA-256-05	303	UA-B33712806MJ	297
		UA-18-256274	298	UA-ALFA-288-05	303	UA-B33716001	297
		UA-18-320338	298	UA-ALFA-320-05	303	UA-B33716006MJ	297
		UA-18-400418	298	UA-ARS096-20	275	UA-B33719201	297
UA-00-313128	298	UA-18-416434	298	UA-ARS128-20	275	UA-B33719206MJ	297
UA-00-313160	298	UA-18-480498	298	UA-ARS160-20	275	UA-B33722401	297
UA-00-313192	298	UA-A3-096128	295	UA-ARS192-20	275	UA-B33722406MJ	297
UA-00-319096	299	UA-A3-128160	295	UA-ARS224-20	275	UA-B33725601	297
UA-00-319128	299	UA-A3-160192	295	UA-ARS256-20	275	UA-B33725606MJ	297
UA-00-319160	299	UA-A3-192224	295	UA-ARS320-20	275	UA-B33732001	297
UA-00-326096	324	UA-A3-256288	295	UA-ARSG30-20	275	UA-B33732006MJ	297
UA-00-326096-20M	324	UA-A3-320352	295	UA-B0-311096	296	UA-B33741606MJ	297
UA-00-326128	324	UA-A4-128-06MJ	296	UA-B0-311096-20M	296	UA-B33748001	297
UA-00-326128-20M	324	UA-A4-160-06MJ	296	UA-B0-311128	296	UA-B33748006MJ	297
UA-00-326160-20M	324	UA-A4-256-06MJ	296	UA-B0-311128-20M	296	UA-BETA-96-05	304
UA-00-337096	307	UA-A4-320-06MJ	296	UA-B0-311160	296	UA-BETA-128-05	304
UA-00-337096-20M	307	UA-A18128-01	298	UA-B0-311160-20M	296	UA-BETA-160-05	304
UA-00-337128	307	UA-A18128-06MJ	298	UA-B0-311192	296	UA-BETA-192-05	304
UA-00-337128-20M	307	UA-A18160-01	298	UA-B0-311192-20M	296	UA-BETA-224-05	304
UA-00-337160	307	UA-A18160-06MJ	298	UA-B0-311224	296	UA-BETA-256-05	304
UA-00-337160-20M	307	UA-A18192-01	298	UA-B0-311224-20M	296	UA-BETA-288-05	304
UA-00-337192	307	UA-A18192-06MJ	298	UA-B0-311256	296	UA-BETA-320-05	304

UA-BO-337416	297	UA-METRO-224-496-18-01	UA-TREX-3500-05	328	US-C7-160-06	319	
UA-BO-337480	297	331	UM-BLOCK-CZ	358	US-C7-192-01	319	
UA-DELTA-96-05	305	UA-METRO-224-496-18-05	UM-BLOCK-NB	358	US-C7-192-06	319	
UA-DELTA-128-05	305	331	UM-BLOCK-ZL	358	US-C7-224-01	319	
UA-DELTA-160-05	305	UA-METRO-256-296-18-01	UM-BUTTON-NB	358	US-C7-224-06	319	
UA-DELTA-192-05	305	331	UM-BUTTON-SZ	358	US-C7-256-01	319	
UA-DELTA-224-05	305	UA-METRO-256-296-18-05	UM-CLOUD-NB	358	US-C7-256-06	319	
UA-DELTA-256-05	305	331	UM-CLOUD-SZ	358	US-C7-288-01	319	
UA-DELTA-288-05	305	UA-METRO-256-596-18-01	UM-CROWN-RZ	358	US-C7-288-06	319	
UA-DELTA-320-05	305	331	UM-FLAMING-RZ	358	US-C7-320-01	319	
UA-DOPPIO192-01	302	UA-METRO-256-596-18-05	UM-FLAMING-SZ	358	US-C7-320-06	319	
UA-DOPPIO416-01	302	331	UM-HEART-RZ	358	US-C7-352-01	319	
UA-GAMMA-96-05	304	UA-METRO-320-396-18-01	UM-KID-C-001	360	US-C7-352-06	319	
UA-GAMMA-128-05	304	331	UM-KID-D-001	360	US-SK0128-06	295	
UA-GAMMA-160-05	304	UA-METRO-320-396-18-05	UM-KID-E-001	360	US-SK0160-06	295	
UA-GAMMA-192-05	304	331	UM-KID-I-002	360	US-SK0192-06	295	
UA-GAMMA-224-05	304	UA-METRO-352-796-18-01	UM-KID-P-001	360	US-SK0224-06	295	
UA-GAMMA-256-05	304	331	UM-KID-Q-001	360	US-SK0256-06	295	
UA-GAMMA-288-05	304	UA-METRO-352-796-18-05	UM-KID-S-001	360	US-SK0320-06	295	
UA-GAMMA-320-05	304	331	UM-KID-U-001	360	US-SK0384-06	295	
UA-HEXI-01	327	UA-PAXO-32-50-05	327	UM-KID-W-001	361	US-SK0448-06	295
UA-HEXI-05	327	UA-PAXO-96-150-05	327	UM-KID-X-001	361	US-SK0480-06	295
UA-HEXI-10M	327	UA-PAXO-224-250-05	327	UM-KID-Y-001	360	US-SK0576-06	295
UA-HEXI-20M	327	UA-PAXO-320-350-05	327	UM-KID-Z-001	361	US-SK0672-06	295
UA-HEXI96-01	327	UA-PAXO-3500-05	327	UM-STAR-NB	358	US-SK0800-06	295
UA-HEXI96-05	327	UA-PICADO-224-496-20M331	UM-STAR-RZ	358	US-SKA128-06	294	
UA-HEXI96-10M	327	UA-PICADO-256-296-20M331	UM-STAR-ZT	358	US-SKA160-06	294	
UA-HEXI96-20M	327	UA-PICADO-256-596-20M331	UM-TWITT-SZ	358	US-SKA192-06	294	
UA-HEXI192-01	327	UA-PICADO-320-396-20M331	UM-TWITT-ZL	358	US-U4-064-01	321	
UA-HEXI192-05	327	UA-PICADO-352-796-20M331	UM-UNICORN-RZ	361	US-U4-064-06	321	
UA-HEXI192-10M	327	UA-PICCO-64-05	303	UP-WP0728-BB	332	US-U4-096-01	321
UA-HEXI192-20M	327	UA-PICCO-128-05	303	UP-WP0728-BK	332	US-U4-096-06	321
UA-HEXI-3500-05	327	UA-PICCO-224-05	303	UP-WP0728-BR	332	US-U4-128-01	321
UA-KAPPA-96-05	306	UA-SIGMA-96-05	305	UP-WP0728-BX	332	US-U4-128-06	321
UA-KAPPA-128-05	306	UA-SIGMA-128-05	305	UP-WP0728-P0	333	US-U4-160-01	321
UA-KAPPA-160-05	306	UA-SIGMA-160-05	305	UP-WP0728-PA-04	333	US-U4-160-06	321
UA-KAPPA-192-05	306	UA-SIGMA-192-05	305	UP-WP0728-PA-07	333	US-U4-192-01	321
UA-KAPPA-224-05	306	UA-SIGMA-224-05	305	UP-WP0728-PB	333	US-U4-192-06	321
UA-KAPPA-256-05	306	UA-SIGMA-256-05	305	UP-WP0728-PC-04	333	US-U4-320-01	321
UA-KAPPA-288-05	306	UA-SIGMA-288-05	305	UP-WP0728-PK	333	US-U4-320-06	321
UA-KAPPA-320-05	306	UA-SIGMA-320-05	305	UP-WP0728-PR	333	UZ-00B224-01	325
UA-LUNA20160-AL	299	UA-TREX-32-50-05	328	UP-WP0728-PX	333	UZ-00B224-02	325
UA-LUNA20160-SN	299	UA-TREX-32-50-20M	328	US-C1-096-06	319	UZ-00B224-05	325
UA-LUNA20192-AL	299	UA-TREX-96-150-05	328	US-C1-128-06	319	UZ-00B224-10	325
UA-LUNA20192-SN	299	UA-TREX-96-150-20M	328	US-C7-096-01	319	UZ-00B224-20	325
UA-LUNA20256-AL	299	UA-TREX-224-250-05	328	US-C7-096-06	319	UZ-00B226-01	325
UA-LUNA20256-SN	299	UA-TREX-224-250-20M	328	US-C7-128-01	319	UZ-00B226-02	325
UA-LUNA20320-AL	299	UA-TREX-320-350-05	328	US-C7-128-06	319	UZ-00B226-05	325
UA-LUNA20320-SN	299	UA-TREX-320-350-20M	328	US-C7-160-01	319	UZ-00B226-10	325

UZ-00B226-20	325	UZ-14-128-03	316	UZ-682480-06	287	UZ-819256-15	290
UZ-01-096-01	311	UZ-14-128-05	316	UZ-804064-01	288	UZ-819256-20	290
UZ-01-096-02	311	UZ-19-032-01	320	UZ-819096-01	290	UZ-819320-01	290
UZ-01-096-03	311	UZ-19-032-02	320	UZ-819096-02	290	UZ-819320-02	290
UZ-01-096-05	311	UZ-19-032-06	320	UZ-819096-05	290	UZ-819320-05	290
UZ-01-128-01	311	UZ-40-032-01	281	UZ-819096-06	290	UZ-819320-06	290
UZ-01-128-02	311	UZ-40-032-02	281	UZ-819096-07	290	UZ-819320-07	290
UZ-01-128-03	311	UZ-40-032-05	281	UZ-819096-10	290	UZ-819320-10	290
UZ-01-128-05	311	UZ-40-032-06	281	UZ-819096-12	290	UZ-819320-12	290
UZ-02C064-01	351	UZ-55-025-01	281	UZ-819096-14	290	UZ-819320-14	290
UZ-02C096-01	351	UZ-55-025-05	281	UZ-819096-20	290	UZ-819320-20	290
UZ-02CF27-01	351	UZ-60-032-01	282	UZ-819128-01	290	UZ-870128-01	292
UZ-04-096-01	312	UZ-60-032-02	282	UZ-819128-02	290	UZ-872224-01	292
UZ-04-096-02	312	UZ-60-032-05	282	UZ-819128-05	290	UZ-872224-05	292
UZ-04-096-03	312	UZ-60-032-06	282	UZ-819128-06	290	UZ-872224-06	292
UZ-04-096-05	312	UZ-71C096-01	351	UZ-819128-07	290	UZ-880016-01	293
UZ-04-128-01	312	UZ-79F160-01	282	UZ-819128-10	290	UZ-883016-01	294
UZ-04-128-02	312	UZ-79F160-06	282	UZ-819128-12	290	UZ-883016-02	294
UZ-04-128-03	312	UZ-79F192-01	282	UZ-819128-14	290	UZ-883016-05	294
UZ-04-128-05	312	UZ-79F192-06	282	UZ-819128-15	290	UZ-883016-06	294
UZ-05-096-01	312	UZ-133128-01	284	UZ-819128-20	290	UZ-ABIAT-128-04	340
UZ-05-096-02	312	UZ-133128-02	284	UZ-819160-01	290	UZ-ACERA-96-04	341
UZ-05-096-03	312	UZ-133128-05	284	UZ-819160-02	290	UZ-ACRYL-Z111160	272
UZ-05-096-05	312	UZ-133128-06	284	UZ-819160-05	290	UZ-ADRIN-96-04	341
UZ-05-128-01	312	UZ-334128-06	286	UZ-819160-06	290	UZ-AGIOS-128-01	270
UZ-05-128-02	312	UZ-334160-06	286	UZ-819160-07	290	UZ-AGIOS-128-05	270
UZ-05-128-03	312	UZ-334192-06	286	UZ-819160-10	290	UZ-ALATR-128-04	333
UZ-05-128-05	312	UZ-334256-06	286	UZ-819160-12	290	UZ-ALRA096-01	306
UZ-06-128-01	314	UZ-334320-06	286	UZ-819160-14	290	UZ-ALRA096-06	306
UZ-06-128-02	314	UZ-335128-06	286	UZ-819160-15	290	UZ-ANCON-128-01	278
UZ-06-128-03	314	UZ-335160-06	286	UZ-819160-20	290	UZ-ANCON-128-05	278
UZ-06-128-05	314	UZ-335192-06	286	UZ-819192-01	290	UZ-ANCON-128-06	278
UZ-07-096-01	314	UZ-335256-06	286	UZ-819192-02	290	UZ-ANCON-192-01	278
UZ-07-096-02	314	UZ-336128-06	287	UZ-819192-05	290	UZ-ANCON-192-05	278
UZ-07-096-03	314	UZ-336160-06	287	UZ-819192-06	290	UZ-ANCON-192-06	278
UZ-07-096-05	314	UZ-336192-06	287	UZ-819192-07	290	UZ-ANCON-256-01	278
UZ-10-096-N04	335	UZ-336256-06	287	UZ-819192-10	290	UZ-ANCON-256-05	278
UZ-12-096-04	335	UZ-336320-06	287	UZ-819192-12	290	UZ-ANCON-256-06	278
UZ-12-096-20M	335	UZ-336416-06	287	UZ-819192-14	290	UZ-ANZIO-96-04	343
UZ-13-096-01	315	UZ-336480-06	287	UZ-819192-15	290	UZ-APRIL-96-04	338
UZ-13-096-02	315	UZ-605032-01	321	UZ-819192-20	290	UZ-ARCH096-AEB	339
UZ-13-096-03	315	UZ-605032-05	321	UZ-819256-01	290	UZ-ARDEA-96-09	336
UZ-13-096-05	315	UZ-682128-06	287	UZ-819256-02	290	UZ-AREZO-96-04	340
UZ-14-096-01	316	UZ-682160-06	287	UZ-819256-05	290	UZ-ASTI096/128-01	274
UZ-14-096-02	316	UZ-682192-06	287	UZ-819256-06	290	UZ-ASTI192/224-01	274
UZ-14-096-03	316	UZ-682224-06	287	UZ-819256-07	290	UZ-ASTI288/320-01	274
UZ-14-096-05	316	UZ-682256-06	287	UZ-819256-10	290	UZ-AVELI-96-04	339
UZ-14-128-01	316	UZ-682320-06	287	UZ-819256-12	290	UZ-AZ-012-04	343
UZ-14-128-02	316	UZ-682416-06	287	UZ-819256-14	290	UZ-AZ-128-04	343

UZ-AZ-160-04	343	UZ-CAMAI-128-12	316	UZ-EAST-128-19	293	UZ-GANZA-160-05	269
UZ-BAGIO-128-01	277	UZ-CAMAI-128-20M	316	UZ-ERIS128-11	353	UZ-GANZA-160-10	269
UZ-BAGIO-128-04	277	UZ-CAPRI-96-01	289	UZ-FLAVIO-96-01	301	UZ-GANZA-160-12	269
UZ-BAGIO-128-05	277	UZ-CAPRI-96-02	289	UZ-FLAVIO-96-06	301	UZ-GENUA128-01	309
UZ-BAGIO-128-06	277	UZ-CAPRI-96-05	289	UZ-FLAVIO-96-16	301	UZ-GENUA128-02	309
UZ-BAGIO-128-07	277	UZ-CAPRI-96-06	289	UZ-FLAVIO-96-20M	301	UZ-GENUA128-05	309
UZ-BAGIO-128-11	277	UZ-CAPRI-128-01	289	UZ-FLAVIO-128-01	301	UZ-GENUA160-01	309
UZ-BAGIO-128-20M	277	UZ-CAPRI-128-02	289	UZ-FLAVIO-128-06	301	UZ-GENUA160-02	309
UZ-BAGIO-160-01	277	UZ-CAPRI-128-05	289	UZ-FLAVIO-128-16	301	UZ-GENUA160-05	309
UZ-BAGIO-160-04	277	UZ-CAPRI-128-06	289	UZ-FLAVIO-128-20M	301	UZ-HILL-128-01	270
UZ-BAGIO-160-05	277	UZ-CAPRI-160-01	289	UZ-FLAVIO-160-01	301	UZ-HILL-128-05	270
UZ-BAGIO-160-06	277	UZ-CAPRI-160-02	289	UZ-FLAVIO-160-06	301	UZ-HILL-128-06	270
UZ-BAGIO-160-07	277	UZ-CAPRI-160-05	289	UZ-FLAVIO-160-16	301	UZ-HILL-128-12	270
UZ-BAGIO-160-11	277	UZ-CAPRI-160-06	289	UZ-FLAVIO-160-20M	301	UZ-HILL-160-01	270
UZ-BAGIO-160-20M	277	UZ-CAPRI-192-01	289	UZ-G0-128-01	310	UZ-HILL-160-05	270
UZ-BAGIO-192-01	277	UZ-CAPRI-192-02	289	UZ-G0-128-05	310	UZ-HILL-160-06	270
UZ-BAGIO-192-04	277	UZ-CAPRI-192-05	289	UZ-G0-128-06	310	UZ-HILL-160-12	270
UZ-BAGIO-192-05	277	UZ-CAPRI-192-06	289	UZ-G0-160-01	310	UZ-IZIS40-01	353
UZ-BAGIO-192-06	277	UZ-CAPRI-256-01	289	UZ-G0-160-05	310	UZ-IZIS40-11	353
UZ-BAGIO-192-07	277	UZ-CAPRI-256-02	289	UZ-G0-160-06	310	UZ-KATAN-320-01	279
UZ-BAGIO-192-11	277	UZ-CAPRI-256-05	289	UZ-G0-192-01	310	UZ-KATAN-320-12	279
UZ-BAGIO-192-20M	277	UZ-CAPRI-256-06	289	UZ-G0-192-05	310	UZ-LATIN-96-04	342
UZ-BAGIO-320-01	277	UZ-CAPRI-320-01	289	UZ-G0-192-06	310	UZ-LUCCA096-01	355
UZ-BAGIO-320-04	277	UZ-CAPRI-320-02	289	UZ-G0-256-01	310	UZ-LUCCA128-01	355
UZ-BAGIO-320-05	277	UZ-CAPRI-320-05	289	UZ-G0-256-05	310	UZ-LUCCA160-01	355
UZ-BAGIO-320-06	277	UZ-CAPRI-320-06	289	UZ-G0-256-06	310	UZ-LUCCA192-01	355
UZ-BAGIO-320-07	277	UZ-CLEO-128-01	268	UZ-G1-128-01	311	UZ-MARSA-64-07	344
UZ-BAGIO-320-11	277	UZ-CLEO-128-05	268	UZ-G1-128-05	311	UZ-MARSA-64-09	344
UZ-BAGIO-320-20M	277	UZ-CLEO-128-06	268	UZ-G1-128-06	311	UZ-MARSA-64-10M	344
UZ-BIANC-96-01	355	UZ-CLEO-160-01	268	UZ-G1-128-13	311	UZ-MARSA-64-11	344
UZ-BIANC-128-01	355	UZ-CLEO-160-05	268	UZ-G1-160-01	311	UZ-MARSA-64-20M	344
UZ-CAD128-01	273	UZ-CLEO-160-06	268	UZ-G1-160-05	311	UZ-MILAN-128-01	288
UZ-CAD160-01	273	UZ-CLEO-192-01	268	UZ-G1-160-06	311	UZ-MILAN-128-05	288
UZ-CAD160-05*	273	UZ-CLEO-192-05	268	UZ-G1-160-13	311	UZ-MILAN-128-06	288
UZ-CAD320-01	273	UZ-CLEO-192-06	268	UZ-G1-192-01	311	UZ-MILAN-128-20M	288
UZ-CAD320-05*	273	UZ-COM0096-01	354	UZ-G1-192-05	311	UZ-MILAN-256-01	288
UZ-CALABRIA160-01	309	UZ-COM0128-01	354	UZ-G1-192-06	311	UZ-MILAN-256-05	288
UZ-CALABRIA160-06	309	UZ-COM0160-01	354	UZ-G1-192-13	311	UZ-MILAN-256-06	288
UZ-CALABRIA192-01	309	UZ-CR0333-A1	352	UZ-G1-256-01	311	UZ-MILAN-256-20M	288
UZ-CALABRIA192-06	309	UZ-CR0333-B1	352	UZ-G1-256-05	311	UZ-MODEN-128-01	283
UZ-CALABRIA224-01	309	UZ-CRA14-128	352	UZ-G1-256-06	311	UZ-MODEN-128-05	283
UZ-CALABRIA224-06	309	UZ-CRA14-192	352	UZ-G1-256-13	311	UZ-MODEN-128-06	283
UZ-CAMAI-96-01	316	UZ-CRA14-320	352	UZ-G1-320-01	311	UZ-MODEN-128-20M	283
UZ-CAMAI-96-02	316	UZ-E6-096-01	324	UZ-G1-320-05	311	UZ-MODEN-160-01	283
UZ-CAMAI-96-06	316	UZ-E6-096-05	324	UZ-G1-320-06	311	UZ-MODEN-160-05	283
UZ-CAMAI-96-09	316	UZ-E6-096-06	324	UZ-G1-320-13	311	UZ-MODEN-160-06	283
UZ-CAMAI-96-10M	316	UZ-E6-128-01	324	UZ-G1-416-01	311	UZ-MODEN-160-20M	283
UZ-CAMAI-96-12	316	UZ-E6-128-05	324	UZ-G1-416-05	311	UZ-MODEN-192-01	283
UZ-CAMAI-96-20M	316	UZ-E6-128-06	324	UZ-G1-416-06	311	UZ-MODEN-192-05	283
UZ-CAMAI-128-01	316	UZ-E6-160-01	324	UZ-G2-160-01	276	UZ-MODEN-192-06	283
UZ-CAMAI-128-02	316	UZ-E6-160-05	324	UZ-G2-160-06	276	UZ-MODEN-192-20M	283
UZ-CAMAI-128-06	316	UZ-E6-160-06	324	UZ-G2-224-01	276	UZ-MONA-128-01-10	271
UZ-CAMAI-128-09	316	UZ-EAST-128-01	293	UZ-G2-224-06	276	UZ-MONA-128-01-20	271
UZ-CAMAI-128-10M	316	UZ-EAST-128-06	293	UZ-GANZA-160-01	269	UZ-MONA-192-01-10	271

UZ-MONA-192-01-20	271	UZ-SIENNA096-01	354	UZ-VITO-288-12	300	WB-WS-18-032	151
UZ-MONA-256-01-10	271	UZ-SIENNA128-01	354	UZ-VITO-288-20M	300	WB-WS-18-033	151
UZ-MONA-256-01-20	271	UZ-SIENNA160-01	354	UZ-WERON-96-04	336	WB-WS-18-060	151
UZ-MONZA16-06	271	UZ-TH096128-01	302	UZ-WERON-96-09	336	WB-WS-24-001	152
UZ-MONZA16-10	271	UZ-TH096128-02	302	UZ-WERON-96-12	336	WB-WS-24-010	152
UZ-MONZA16-20	271	UZ-TH096128-05	302	UZ-WERON-128-04	336	WB-WS-24-020	152
UZ-MONZA160-06	271	UZ-TH096128-06	302	UZ-WERON-128-09	336	WB-WS-24-030	152
UZ-MONZA160-10	271	UZ-TH160192-01	302	UZ-WERON-128-12	336	WB-WS-24-031	152
UZ-MONZA160-20	271	UZ-TH160192-02	302	UZ-WP1146-04	346	WB-WS-24-032	152
UZ-MONZA256-06	271	UZ-TH160192-05	302	UZ-Z10096-01	315	WB-WS-24-033	152
UZ-MONZA256-10	271	UZ-TH160192-06	302	UZ-Z10096-02	315	WB-WS-24-060	152
UZ-MONZA256-20	271	UZ-TH288320-01	302	UZ-Z10096-03	315	W-CUSTOMI-60L450	252
UZ-MONZA384-06	271	UZ-TH288320-02	302	UZ-Z10096-05	315	W-CUSTOMI-60L500	252
UZ-MONZA384-10	271	UZ-TH288320-05	302	UZ-Z10128-01	315	W-CUSTOMI-80L450	253
UZ-MONZA384-20	271	UZ-TH288320-06	302	UZ-Z10128-02	315	W-CUSTOMI-80L500	253
UZ-O160PR-01	272	UZ-TIVOL-192-01	276	UZ-Z10128-03	315	WG-KOSZ60-10	192
UZ-O192PR-01	272	UZ-TIVOL-192-12	276	UZ-Z10128-05	315	WG-KOSZ60-60	192
UZ-O256PR-01	272	UZ-TIVOL-192-13	276			WG-KOSZ70-10	192
UZ-OLBIA-96-04	342	UZ-TIVOL-320-01	276			WG-KOSZ70-60	192
UZ-OLBIA-128-04	342	UZ-TIVOL-320-12	276			WG-KOSZ80-10	192
UZ-PADWA192-01	279	UZ-TIVOL-320-13	276			WG-KOSZ80-60	192
UZ-PADWA192-06	279	UZ-VARES-96-01	284			WG-KOSZ90-10	192
UZ-PALER-96-07	334	UZ-VARES-96-02	284	W-AKC-HERBI-L450	255	WG-KOSZ90-60	192
UZ-PALER-128-07	334	UZ-VARES-96-05	284	W-AKC-HERBI-L500	255	WG-KOSZM60-10	191
UZ-PRATO-160-01	278	UZ-VARES-96-06	284	W-AKC-HOLDI-L450	256	WG-KOSZM60-60	191
UZ-PRATO-160-05	278	UZ-VARES-128-01	284	W-AKC-HOLDI-L500	256	WG-KOSZM70-10	191
UZ-PRATO-160-06	278	UZ-VARES-128-02	284	W-AKC-KNIFI-L450	255	WG-KOSZM70-60	191
UZ-PRATO-320-01	278	UZ-VARES-128-05	284	W-AKC-KNIFI-L500	255	WG-KOSZM80-10	191
UZ-PRATO-320-05	278	UZ-VARES-128-06	284	WA-MALAG-A0-01	374	WG-KOSZM80-60	191
UZ-PRATO-320-06	278	UZ-VARES-192-01	284	WA-MALAG-A0-02	374	WG-KOSZM80-60	191
UZ-R132-A1-01	326	UZ-VARES-192-02	284	WA-MALAG-A0-05	374	WG-KOSZM90-10	191
UZ-R132-A1-02	326	UZ-VARES-192-05	284	WA-MALAG-A0-20	374	WG-KOSZM90-60	191
UZ-R132-A1-06	326	UZ-VARES-192-06	284	WA-MALAG-B0-01	375	WG-KOSZR60-10	193
UZ-R160BI-01	273	UZ-VASTO-96-09	334	WA-MALAG-B0-02	375	WG-KOSZR60-60	193
UZ-R160PR-01	273	UZ-VASTO-128-09	334	WA-MALAG-B0-05	375	WG-KOSZR70-10	193
UZ-R256BI-01	273	UZ-VER160-08	274	WA-MALAG-B0-20	375	WG-KOSZR70-60	193
UZ-R256PR-01	273	UZ-VETA-128-01	269	WB-073024-01	149	WG-KOSZR80-10	193
UZ-REN096-04A	348	UZ-VETA-128-05	269	WB-073024-06	149	WG-KOSZR80-60	193
UZ-RENG01-04A	348	UZ-VETA-128-12	269	WB-073025-01	150	WG-KOSZR90-10	193
UZ-RENG02-04A	348	UZ-VETA-160-01	269	WB-073025-06	150	WG-KOSZR90-60	193
UZ-ROS160-20	273	UZ-VETA-160-05	269	WB-073026-01	150	WG-POBUW60-10	194
UZ-ROS256-20	273	UZ-VETA-160-12	269	WB-073026-06	150	WG-POBUW60-60	194
UZ-ROYAL1-96-10/03	345	UZ-VETA-320-01	269	WB-WS-12-001	151	WG-POBUW60M-60	195
UZ-ROYAL2-96-10/03	345	UZ-VETA-320-05	269	WB-WS-12-010	151	WG-POBUW70-10	194
UZ-ROYAL3-96-10/03	345	UZ-VETA-320-12	269	WB-WS-12-020	151	WG-POBUW70-60	194
UZ-ROYAL4-96-03	345	UZ-VINCE-96-04	338	WB-WS-12-030	151	WG-POBUW70M-60	195
UZ-ROYAL5-96-10-03	345	UZ-VITO-160-01	300	WB-WS-12-031	151	WG-POBUW80-10	194
UZ-ROYAL5-128-10-03	345	UZ-VITO-160-05	300	WB-WS-12-032	151	WG-POBUW80-60	194
UZ-S50-A1-01	326	UZ-VITO-160-07	300	WB-WS-12-033	151	WG-POBUW80M-60	195
UZ-S50-A1-02	326	UZ-VITO-160-12	300	WB-WS-12-060	151	WG-POBUW90-10	194
UZ-S50-A1-05	326	UZ-VITO-160-20M	300	WB-WS-18-001	151	WG-POBUW90-60	194
UZ-S50-A1-06	326	UZ-VITO-288-01	300	WB-WS-18-010	151	WG-POBUW90M-10	195
UZ-SENIOR-160-01	268	UZ-VITO-288-05	300	WB-WS-18-020	151	WG-POBUW90M-60	195
UZ-SENIOR-160-05	268	UZ-VITO-288-07	300	WB-WS-18-030	151	WG-POBUWM60-10	195
				WB-WS-18-031	151	WG-POBUWM70-10	195

W

WG-POBUWM80-10	195	WW-K00J03-01	219	W-WOBU80-BP-10	203	WW-WSL500-01	222
WG-PRZEG60-10	196	WW-KJ0101-01	217	W-WOBU80-BP-60	202	WW-WSL500-01B	222
WG-PRZEG60-60	196	WW-KJ0201-01	218	W-WOBU80-GX-10	203	WW-WSL000-01	216
WG-PRZEG70-10	196	W-WK060-BP-10	207	W-WOBU80-GX-60	202	WW-WSP000-01	216
WG-PRZEG70-60	196	W-WK060-BP-60	206	W-WOBU80-VE-10	203	WW-WSP060-05	212
WG-PRZEG80-10	196	W-WK060-GX-10	207	W-WOBU80-VE-60	202	WW-WSP060-PW	212
WG-PRZEG80-60	196	W-WK060-GX-60	206	W-WOBU90-BP-10	203	WW-WSP070-05	212
WG-PRZEG90-10	196	W-WK060-VE-10	207	W-WOBU90-BP-60	202	WW-WSP070-PW	212
WG-PRZEG90-60	196	W-WK060-VE-60	206	W-WOBU90-GX-10	203	WW-WSP080-05	212
WG-RDRO-10	199	W-WK070-BP-10	207	W-WOBU90-GX-60	202	WW-WSP080-PW	212
WG-RDRO-60	199	W-WK070-BP-60	206	W-WOBU90-VE-10	203	WW-WSP090-05	212
WG-RDRP-10	199	W-WK070-GX-10	207	W-WOBU90-VE-60	202	WW-WSP090-PW	212
WG-RDRP-60	199	W-WK070-GX-60	206	WW-PASEK0-05	221	WW-WSPP00-01	216
WG-RRPS300-10	199	W-WK070-VE-10	207	WW-SE0102-01	221	WW-WUBR00-01	220
WG-RRPS300-60	199	W-WK070-VE-60	206	W-WSPD60-BP-10	205	WW-ZWBUT2-10	224
WG-WSP0D60-10	197	W-WK080-BP-10	207	W-WSPD60-BP-60	204	WW-ZWBUT2-20	224
WG-WSP0D60-60	197	W-WK080-BP-60	206	W-WSPD60-GX-10	205	WZ-00-K24-04	380
WG-WSP0D70-10	197	W-WK080-GX-10	207	W-WSPD60-GX-60	204	WZ-804-20-01	365
WG-WSP0D70-60	197	W-WK080-GX-60	206	W-WSPD60-VE-10	205	WZ-804-20-05	365
WG-WSP0D80-10	197	W-WK080-VE-10	207	W-WSPD60-VE-60	204	WZ-804-20-06	365
WG-WSP0D80-60	197	W-WK080-VE-60	206	W-WSPD70-BP-10	205	WZ-A0-K23-01	370
WG-WSP0D90-10	197	W-WK090-BP-10	207	W-WSPD70-BP-60	204	WZ-A0-K23-02	370
WG-WSP0D90-60	197	W-WK090-BP-60	206	W-WSPD70-GX-10	205	WZ-A0-K23-03	370
W-INSERTI-L450	254	W-WK090-GX-10	207	W-WSPD70-GX-60	204	WZ-A0-K23-04	370
W-INSERTI-L500	254	W-WK090-GX-60	206	W-WSPD70-VE-60	204, 205	WZ-A0-K23-05	370
WK-CAM15-12-P	164	W-WK090-VE-10	207	W-WSPD80-BP-10	205	WZ-A0-K23-06	370
WK-CAM-FI35	162	W-WK090-VE-60	206	W-WSPD80-BP-60	204	WZ-A0-K23-07	370
WK-CF0750-01	165	WW-KOSZ60-05	211	W-WSPD80-GX-10	205	WZ-A0-K23-20	370
WK-CF6450-01	165	WW-KOSZ60-PW	211	W-WSPD80-GX-60	204	WZ-A0-K24-01	372
WK-D0310-001	163	WW-KOSZ70-05	211	W-WSPD80-VE-10	205	WZ-A0-K24-02	372
WK-D0313-001	163	WW-KOSZ70-PW	211	W-WSPD80-VE-60	204	WZ-A0-K24-03	372
WK-D0316-001	163	WW-KOSZ80-05	211	W-WSPD90-BP-10	205	WZ-A0-K24-04	372
WK-D0320-001	163	WW-KOSZ80-PW	211	W-WSPD90-BP-60	204	WZ-A0-K24-05	372
WK-D0325-001	163	WW-KOSZ90-05	211	W-WSPD90-GX-10	205	WZ-A0-K24-07	372
WK-D0330-001	163	WW-KOSZ90-PW	211	W-WSPD90-GX-60	204	WZ-A0-K24-20	372
WK-D0416-001	163	WW-KRAW00-20	217	W-WSPD90-VE-10	205	WZ-B0-K23-01	370
WK-D0425-001	163	W-WKRP-BP-10	208	W-WSPD90-VE-60	204	WZ-B0-K23-02	370
WK-D0430-001	163	W-WKRP-BP-60	208	WW-SP0DN0-05	219	WZ-B0-K23-03	370
WK-D0440-001	163	W-WKRP-GX-10	208	WW-WSD250-01B	223	WZ-B0-K23-04	370
WK-D0460-001	163	W-WKRP-GX-60	208	WW-WSD300-01B	223	WZ-B0-K23-05	370
WK-D3516-001	163	W-WKRP-VE-10	208	WW-WSD350-01B	223	WZ-B0-K23-06	370
WK-D3525-001	163	W-WKRP-VE-60	208	WW-WSD400-01B	223	WZ-B0-K23-07	370
WK-D3530-001	163	W-WOBU60-BP-10	203	WW-WSD450-01B	223	WZ-B0-K23-20	370
WK-DOW63X45-P	164	W-WOBU60-BP-60	202	WW-WSD500-01B	223	WZ-B0-K24-01	373
WK-MUFAWK-01	162	W-WOBU60-GX-10	203	WW-WSL250-01	222	WZ-B0-K24-02	373
WK-TCAMS-D-88	162	W-WOBU60-GX-60	202	WW-WSL250-01B	222	WZ-B0-K24-03	373
WK-TRZP35-01	162	W-WOBU60-VE-10	203	WW-WSL300-01	222	WZ-B0-K24-04	373
WK-TRZP55-01	162	W-WOBU60-VE-60	202	WW-WSL300-01B	222	WZ-B0-K24-05	373
WS-QUAD-14-06	364	W-WOBU70-BP-10	203	WW-WSL350-01	222	WZ-B0-K24-07	373
WS-ROND-14-06	365	W-WOBU70-BP-60	202	WW-WSL350-01B	222	WZ-B0-K24-20	373
WS-SOLO-14-06	364	W-WOBU70-GX-10	203	WW-WSL400-01	222	WZ-C0-K24-01	374
WW-2KOSZ0-05	209	W-WOBU70-GX-60	202	WW-WSL400-01B	222	WZ-C0-K24-02	374
WW-K0AJ03-01	218	W-WOBU70-VE-10	203	WW-WSL450-01	222	WZ-C0-K24-03	374
WW-K0AJ04-01	220	W-WOBU70-VE-60	202	WW-WSL450-01B	222	WZ-C0-K24-04	374

WZ-C0-K24-05	374	WZ-ORVIE-B0-09	379	ZM-ECHC09BEO	10	ZP-CIG-19UZE	35
WZ-C0-K24-20	374	WZ-SCTYLPR-BWK	156	ZM-ECHC09H04-BE	12	ZP-CIHC070ZE	33
WZ-CORDOBA-01	368	WZ-SCTYLPR-WK	156	ZM-ECHC09ZEO	10	ZP-CIHC080ZE	32
WZ-CORDOBA-06	368	WZ-TOLED-A0-01	366	ZM-ECKT165BE	21	ZP-CIHC090ZE	32
WZ-CORDOBA-20M	368	WZ-TOLED-A0-02	366	ZM-ECKT165ZE	21	ZP-COCA450-BE	30
WZ-CORUNA-D-04	377	WZ-TOLED-A0-05	366	ZM-HCKT30-BE	18	ZP-COCA450-ZE	30
WZ-CORUNA-D-07	377	WZ-TOLED-A0-06	366	ZM-HCKT30-ZE	18	ZP-COCA7450-BE	30
WZ-CORUNA-D-17	377	WZ-TOLED-A0-20M	366	ZM-HCKT45-3DBEO	19	ZP-CONL07-BE	24
WZ-CORUNA-D-20M	377	WZ-TOLED-B0-01	366	ZM-HCKT45-BE	18	ZP-CONL07-ZE	24
WZ-CORUNA-M-04	377	WZ-TOLED-B0-02	366	ZM-HCKT45-ZE	18	ZP-CONL08-BE	24
WZ-CORUNA-M-07	377	WZ-TOLED-B0-05	366	ZM-HCKT90-3DBEO	20	ZP-CONL08-ZE	24
WZ-CORUNA-M-17	377	WZ-TOLED-B0-06	366	ZM-HCKT90-BE	19	ZP-CONL09-BE	23
WZ-CORUNA-M-20M	377	WZ-TOLED-B0-20M	366	ZM-HCKT90-ZE	19	ZP-CONL09-ZE	23
WZ-D-892-02	376	WZ-TOLED-C0-01	367	ZM-HCKT155BE	20	ZP-JUNIOR-00	39
WZ-D-892-05	376	WZ-TOLED-C0-02	367	ZM-HCKT155ZE	20	ZP-KT30H2-BE	26
WZ-E-018-01	376	WZ-TOLED-C0-05	367	ZM-HCKT165-3DBEO	21	ZP-KT45H2-ZE	27
WZ-E-018-02	376	WZ-TOLED-C0-06	367	ZM-HCRALU9BE	37	ZP-KT90H2-BE	27
WZ-E-018-05	376	WZ-TOLED-C0-20M	367	ZM-HCREG07-ZEO	14	ZP-KT90H2-ZE	27
WZ-E-018-06	376	WZ-WALENCIA-01	368	ZM-HCREG08-ZEO	14	ZP-KT135H2BE	29
WZ-E-018-20M	376	WZ-WALENCIA-06	368	ZM-HCREG09-ZEO	13	ZP-KT135H2ZE	29
WZ-GRANA-A0-01	372	WZ-WALENCIA-20M	368	ZM-INHC070BEO	17	ZP-KT165H2BE	29
WZ-K23-D1-01	371			ZM-INHC070ZE0	17	ZP-KT165H2ZE	29
WZ-K23-D1-02	371	Z		ZM-INHC080BEO	17	ZP-KT0270-BE	38
WZ-K23-D1-03	371			ZM-INHC080ZE0	17	ZP-KTK90H6BE	28
WZ-K23-D1-05	371			ZM-INHC090BEO	16	ZP-KTK90H6ZE	28
WZ-K23-D1-06	371	ZASL-MIMO35-10	162	ZM-INHC090ZE0	16	ZP-KTKN90H0	28
WZ-K23-E1-01	371	ZC-GTV-12-00	40	ZM-KT45H2-BE	27	ZP-PO7H045BE	31
WZ-K23-E1-02	371	ZC-GTV-14-00	40	ZP-BICN070BEO	26	ZP-POH045BEO	31
WZ-K23-E1-03	371	ZK-FORCE-KPL	157	ZP-BICN070ZE0	26	ZP-POH045ZE0	31
WZ-K23-E1-05	371	ZK-R1-KPL-10	158	ZP-BICN072BEO	26	ZP-RALUH2-00	36
WZ-K23-E1-06	371	ZK-R1-KPL-30	158	ZP-BICN072ZE0	26	ZP-RALUH2-07	37
WZ-K2201-01	369	ZK-STRONG-KPL	158	ZP-BICN080BEO	25	ZP-RALUH2-08	36
WZ-K2201-06	369	ZK-ZAS-KPL-10	159	ZP-BICN080ZE0	25	ZP-SKR-00-80	40
WZ-K2201-CS	369	ZK-ZAS-KPL-31	159	ZP-BICN082BEO	25	ZT-HF-01-D00	38, 39
WZ-K2201-CZ	369	ZK-ZAS-KPL-32	159	ZP-BICN082ZE0	25	ZZ-16-103-01	425
WZ-K2201-NB	369	ZK-ZAW-R0-10	157	ZP-BICN090BEO	25	ZZ-20-103-01	425
WZ-K2201-PM	369	ZK-ZAW-R0-30	157	ZP-BICN090ZE0	25	ZZ-30-103-01	425
WZ-K2201-RZ	369	ZK-ZAW-R0-32	157	ZP-BICN092BEO	25	ZZ-B0-105-01	424
WZ-K2201-ZL	369	ZM-CIHC07ZE	33	ZP-BICN092ZE0	25	ZZ-BA-SK0-01	428
WZ-K2202-01	369	ZM-CIHC08ZE	32	ZP-BIDI07-3DBEO	23	ZZ-C1-288-01	429
WZ-K2202-06	369	ZM-CIHC09ZE	32	ZP-BIDI08-3DBEO	22	ZZ-C5-288-01	429
WZ-K2202-CS	369	ZM-CNHC07BR2	16	ZP-BIDI09-3DBEO	22	ZZ-C6-288-01	429
WZ-K2202-CZ	369	ZM-CNHC08BR2	15	ZP-CIBI7H0ZE	34	ZZ-C8-288-01	429
WZ-K2202-PM	369	ZM-CNHC09BR2	15	ZP-CIBI8H0ZE	34	ZZ-CF-138-01	423
WZ-K2202-RZ	369	ZM-DCHC07-3DBEO	10	ZP-CIBI9H0ZE	33	ZZ-G0-328-01	428
WZ-MADRYT-04	378	ZM-DCHC07-3DZEO	10	ZP-CIG-070ZE	35	ZZ-KLMASTER	423
WZ-MADRYT-07	378	ZM-DCHC08-3DBEO	9	ZP-CIG-07UZE	35	ZZ-KM-138-01	422
WZ-MADRYT-15	378	ZM-DCHC08-3DZEO	9	ZP-CIG-090ZE	35	ZZ-M0-201-01	427
WZ-MADRYT-20M	378	ZM-DCHC09-3DBEO	9	ZP-CIG-09UBE	35	ZZ-SZ-407-01	425
WZ-MALAG-C0-01	375	ZM-DCHC09-3ZBEO	9	ZP-CIG-09UZC	35	ZZ-SZ-408-01	426
WZ-MALAG-C0-02	375	ZM-ECHC07BEO	11	ZP-CIG-09UZE	35	ZZ-SZ-409-01	426
WZ-MALAG-C0-05	375	ZM-ECHC07ZE0	11	ZP-CIG-170ZE	35	ZZ-Z0-202-01	427
WZ-MALAG-C0-20	375	ZM-ECHC08BEO	11	ZP-CIG-17UZE	35	ZZ-ZN-138-01	422
WZ-ORVIE-A0-09	379	ZM-ECHC08ZE0	11	ZP-CIG-190ZE	35	ZZ-ZN-338-01	424

Niniejszy katalog produktów został przygotowany przez GTV Poland. Poprzez ciągłe udoskonalanie swojej oferty, zgodnie z wymogami rynkowymi i prawnymi, GTV Poland zastrzega sobie prawo do wprowadzania zmian w przedstawionym asortymencie. Prezentowana publikacja nie jest ofertą w rozumieniu Kodeksu Cywilnego. Rzeczywiste produkty mogą odbiegać od poglądowych zdjęć i rysunków zamieszczonych w publikacji. GTV Poland zastrzega sobie prawo do zmian i błędów w druku.

This product catalogue has been prepared by GTV Poland. Constantly improving its products so as to follow market and legal requirements, GTV Poland reserves the right to introduce changes in the presented product range. The present publication does not constitute an offer within the meaning of the Civil Code. The real products can differ from the example photographs and drawings in the publication. GTV Poland reserves the right to make changes and printing errors.

Данный каталог был создан компанией GTV Poland. В соответствии с действующим законодательством и требованиями рынка, компания GTV Poland оставляет за собой право вносить изменения в ассортимент предлагаемого товара. Данная публикация носит информационно-ознакомительный характер и не является коммерческим предложением в понимании права. Компания не несет ответственности за возможные цветковые расхождения, опечатки и неточности.



GTV

ul. Przejazdowa 21
05-800 Pruszków
Poland

 + 48 22 44 47 272

 + 48 22 44 47 366

 + 48 22 44 47 324

 + 48 22 44 47 391

 + 48 22 44 47 569

 + 420 591 160 091

 ООО 140073, РФ, «ГТВ РУС»
Московская область,
г. Люберецы, пос.Томилино
мкрн. Птицефабрика, Литер 7А
+ 7 495 640 15 88

 GTV Croatia d.o.o
Kovinska 4a, 10000 Zagreb
Hrvatska
+ 385 1 798 8089

 GTV Czech Distribution s.r.o.
CTPark Ostrava, Na Rovince 879
720 00 Ostrava Hrabová
Česká republika
+420 591 160 091

 GTV España Herrajes e Iluminación, S.L.
Avenida Aragón 30 8
46021 Valencia
Spain
+34 960 468 666

fax: +48 22 444 75 01
e-mail: info@gtv.com.pl
www.gtv.com.pl

Follow us on:

